



HARVARD UNIVERSITY.



LIBRARY

OF THE

MUSEUM OF COMPARATIVE ZOÖLOGY.

12,351

*Exchange.*

*November 29, 1905 - September 17, 1908.*









SEP 21 1908

# RECORDS

OF THE

# AUSTRALIAN MUSEUM.

EDITED BY THE CURATOR

---

Vol. VI.

---

PRINTED BY ORDER OF THE TRUSTEES.

R. ETHERIDGE, Junr., J.P.,

Curator.

SYDNEY, 1905—1907

J





# CONTENTS.

---

No. 1.

Published 15th June, 1905.

	Page
The Breeding habits of the Paradise Fish. By Edgar R. Waite	1
Description of the Mutilated Cranium of a large Fish from the Lower Cretaceous of Queensland. By R. Etheridge, Junr.	5
Studies in Australian Araneidæ No. 4. By W. J. Rainbow	9
An addition to the Lacertilian Fauna of the Solomon Islands. By Edgar R. Waite	13
The Further Discovery of Dugong Bones on the Coast of New South Wales. By R. Etheridge, Junr.	17
On an Insular Form of <i>Melithreptus brevirostris</i> , Vigors and Horsfield. By Alfred J. North	20
Notes on the Architecture, Nesting Habits, and Life Histories of Australian Araneidæ, based on Specimens in the Australian Museum. By W. J. Rainbow	22
Notes on the Varied Honey-Eater. By Alfred J. North	29
Opal Pseudomorphs from White Cliffs, N.S.W. By C. Anderson, M.A., B.Sc., and H. Stanley Jevons, M.A., B.Sc.	31
Occasional Notes—	
I. Climbing Habits of an Australian Snake. By Edgar R. Waite	38
II. <i>Pseudaphritis urvillii</i> , Cuv. & Val., a Fish new to Western New South Wales. By Edgar R. Waite, F.L.S.	...

## No. 2.

Published 15th September, 1905.

Mollusca from One Hundred and Eleven Fathoms, East of Cape Byron, New South Wales. By Charles Hedley. . . . .	41
Notes on Fishes from Western Australia, No. 3. By Edgar R. Waite	55
Mineralogical Notes, No. 2.—Topaz, Barite, Anglesite, Cerussite and Zircon. By C. Anderson, M.A., B.Sc. . . . .	83
On a Large Example of <i>Megalattractus aruanus</i> , L. By Charles Hedley.	98
Notes on Australian Siphonaptera. By W. J. Rainbow . . . . .	101
The Osteology of the New Guinea Turtle. By Edgar R. Waite. . . . .	110
Occasional Notes—	
III Western Australian Prawns and Sponges. By T. Whitelegge.	119

## No. 3.

Published 19th June, 1906.

On Two Early Australian Ornithologists. By Alfred J. North . . . . .	121
The Cranial Buckler of a Dipnoan Fish, from the Devonian Beds of the Murrumbidgee River, N.S.W. By R. Etheridge, Junr. . . . .	129
Mineralogical Notes: No. 3.—Axinite, Petterdite, Crocoite, and Datolite. By C. Anderson, M.A., B.Sc. . . . .	133
A Synopsis of Australian Acarina. By W. J. Rainbow . . . . .	145
Description of and Notes on some Australian and Tasmanian Fishes. By Edgar R. Waite, . . . . .	194
Mollusca from Three Hundred Fathoms, off Sydney. By C. Hedley, and W. F. Petterd . . . . .	211
Studies in Australian Sharks, No. 3. By Edgar R. Waite . . . . .	226
On a Variety of <i>Gonva coronata</i> . By Alfred J. North . . . . .	230
Occasional Notes—	
IV. Crustacea new to Australia. By Allan R. McCulloch . . . . .	231

## No. 4.

Published 23rd January, 1907

Aboriginal Work-shops on the Coast of New South Wales, and their Contents. By R. Etheridge, Junr., and Thomas Whitelegge	233
On the Ohgochata from the Blue Lake, Mount Kosciusko. By Prof. W. B. Benham, D.Sc., M.A.	251
Mineralogical Notes: No. 4. Orthoclase in New South Wales. By C. Anderson, M.A., B.Sc.	265
The Results of Deep Sea Investigation in the Tasman Sea. I. The Expedition of H.M.C.S. "Miner."	
1. Introductory Note on the First Deep-Sea Cruise. By Prof. W. A. Haswell, M.A., D.Sc. and C. Hedley	271
2. The Colonial Radiolaria of the Tasman Sea. By Prof. W. A. Haswell, M.A., D.Sc.	273
3. Mollusca from Eighty Fathoms off Narrabeen. By C. Hedley	283
4. Foraminiferal Sand Dredged Twenty-two Miles east of Sydney at a Depth of Eighty Fathoms. By E. J. Goddard, B.A., B.Sc.	305
Note upon <i>Mus tomponi</i> , Ramsay. By Allan R. McCulloch	312
Two New Species of <i>Collembola</i> . By W. J. Rainbow	313
Occasional Notes—	
V. The Generic Name <i>Urepilogaster</i> . By Edgar R. Waite	315
VI. Note on an Unusual Set of Stone Plover's Eggs. By A. J. North	315

## No. 5.

Published 18th July, 1907.

Lower Cretaceous Fossils from the Sources of the Barcoo, Ward and Niva Rivers, South Central Queensland. By R. Etheridge, Junr.	317
Notes on the Architecture of Australian Araneidae. Part 6, Entelegynæ. By W. J. Rainbow	330
Additions to the Avi-Fauna of the County of Cumberland. By Alfred J. North	339

Results of Deep-Sea Investigation in the Tasman Sea. II. The Expedition of the "S.S. Woy Woy."	
1. Fishes and Crustaceans from Eight Hundred Fathoms. By Allan R. McCulloch. . . . .	345
Mollusea from Eight Hundred Fathoms, Thirty-five Miles East of Sydney. By Charles Hedley. . . . .	356
North Queensland Ethnography. Bulletin No. 9. Burial Ceremonies and Disposal of the Dead. By Walter E. Roth. . . . .	365
Mineralogical Notes: No. 5.—Cassiterite, Cerussite, Zeolites and other Australian Minerals. By C. Anderson, M.A., B.Sc. . . . .	404
Occasional Notes—	
VII. Eggs of <i>Cacomantis inasperatus</i> , Gould. By A. J. North . . . . .	423

---

No. 6.

Published 20th March, 1908

Title Page and Index.

## LIST OF THE CONTRIBUTORS.

With Reference to the Articles contributed by each.

### Anderson, Chas —

	Page
Mineralogical Notes, No. II.—Topaz, Barite, Anglesite, Cerussite and Zircon . . . . .	83
No. III.—Axinite, Petterdite, Crocoite, and Datolite . . . . .	133
No. IV.—Orthoclase in New South Wales . . . . .	265
No. V.—Cassiterite, Cerussite, Zeolites and other Australian Minerals . . . . .	404

### Anderson, Chas., and H S. Jevons —

Opal Pseudomorphs from White Cliffs, N.S.W. . . . .	31
---	----

### Benham, W. B. —

On the Oligochaeta from the Blue Lake, Mount Kosciusko . . . . .	251
--	-----

### Etheridge R. Junr. —

Description of the Mutilated Cranium of a large Fish from the Lower Cretaceous of Queensland . . . . .	5
The Further Discovery of Dugong Bones on the Coast of New South Wales . . . . .	17
The Cranial Buckler of a Dipnoan Fish, from the Devonian Beds of the Murrumbidgee River, N.S.W. . . . .	129
Lower Cretaceous Fossils from the Sources of the Barcoo, Ward, and Nive Rivers, South Central Queensland . . . . .	317

### Etheridge, R., Junr. and Thos. Whitelegge—

Aboriginal Workshops on the Coast of New South Wales, and their Contents . . . . .	233
--	-----

**Goddard, E. J.**—

- Foraminiferal Sand Dredged Twenty-two Miles east of Sydney at a  
Depth of Eighty Fathoms ... .. 305

**Haswell, W. A.**—

- The Colonial Radiolaria of the Tasman Sea ... .. 273

**Haswell, W. A. and Chas. Hedley**—

- Introductory Note on the First Deep Sea Cruise ... .. 271

**Hedley, Charles**—

- Mollusca from One Hundred and Eleven Fathoms, East of Cape  
Byron, New South Wales ... .. 41
- On a Large Example of *Megalatractus aruanns* ... .. 98
- Mollusca from Eighty Fathoms off Narrabeen ... .. 283
- Mollusca from Eight Hundred Fathoms, Thirty-five Miles East of  
Sydney. ... .. 356

**Hedley Chas. and W. F. Petterd**—

- Mollusca from Three Hundred Fathoms, off Sydney ... .. 211

**McCulloch, Allan R.**—

- Crustacea new to Australia ... .. 231
- Note upon *Mus tomsoni*, Ramsay ... .. 312
- Fishes and Crustaceans from Eight Hundred Fathoms, thirty-five  
miles East of Sydney ... .. 345

**North, A. J.**—

- On an Insular Form of *Melithreptus brevirostris*, Vigors and Hors-  
field ... .. 20
- Notes on the Varied Honey-Eater ... .. 29
- On Two Early Australian Ornithologists ... .. 121
- On a Variety of *Goura coronata* ... .. 230
- Note on an Unusual Set of Stone Plover's Eggs ... .. 315
- Additions to the Avi-Fauna of the County of Cumberland ... .. 339
- Eggs of *Cacomantis insperatus*, Gould ... .. 423

**Rainbow, W. J.—**

Studies in Australian Araneidae, No 4....	9
Notes on the Architecture, Nesting Habits, and Life Histories of Australian Araneidae, based on Specimens in the Australian Museum	22
Notes on Australian Siphonaptera	101
A Synopsis of Australian Acarina	145
Two New Species of <i>Collembola</i>	313
Notes on the Architecture of Australian Araneidae, Part 6. Entelegyne...	330

**Roth, Walter E.—**

North Queensland Ethnography. Bulletin No. 9. Burial Ceremonies and Disposal of the Dead	365
--	-----

**Waite, Edgar R.—**

The Breeding habits of the Paradise Fish	1
An Addition to the Lacertilian Fauna of the Solomon Islands	13
Climbing Habits of an Australian Snake	38
<i>Pseudaphritis urvillii</i> , Cuv & Val., a Fish new to Western New South Wales	38
Notes on Fishes from Western Australia, No. 3	55
The Osteology of the New Guinea Turtle	110
Description of and Notes on some Australian and Tasmanian Fishes	194
Studies in Australian Sharks, No. 3	226
The Generic Name <i>Crepilogaster</i>	315

**Whitelegge, T.—**

Western Australian Prawns and Sponges	119
---------------------------------------	-----





## LIST OF THE PLATES.

---

### PART I.

- I-II. *Ichthyodectes marathonensis*.
- III. Portion of web of *Amanobius socialis*.
- IV. Portion of rib of *Halicore dugong*.
- V. *Melithreptus brevirostris*.  
*Melithreptus magnirostris*.  
Nest and Eggs of *Ptilotis versicolor*.
- VI. Opal Pseudomorphs.
- VII. Glauberite Crystals and Opal Pseudomorphs.

### PART II

- VIII. *Synodus sagenus*.  
*Cynoglossus broadhursti*.
- IX. *Terapon humeralis*.
- X. *Neotypus obliquus*.
- XI. *Chatodon assarius*.  
*Dipulus cæcus*.
- XII. *Hypsypops microlepis*.
- XIII. *Pseudolabrus punctulatus*.
- XIV. *Bramichthys woodwardi*.
- XV. *Pataecus maculatus*.
- XVI. *Pseudomonacanthus galii*.
- XVII. *Chatodermis maccullochi*.
- XVIII. Topaz.
- XIX. Topaz.  
Barite.  
Angel-site.
- XX. Cerussite.  
Zircon.
- XXI.-XXII. *Megalatractus arnauus*.
- XXIII. *Echidnophaga ambulans*.
- XXIV.-XXVII. *Carettochelys insculpta*.

## PART III.

- XXVIIa. Mural Tablet in St. James Church, Sydney, erected in memory of John Gilbert, Ornithologist.
- XXVIII. *Ganorhynchus sussmilchi*. *Eth. fil.*
- XXIX-XXX. Axinite.
- XXXI. Axinite, Petterdite, and Crocoite.
- XXXII. Petterdite (Mimetite).
- XXXIII. Datolite
- XXXIV. *Peltorhamphus basseusis*.
- XXXV. *Rhombosolea flexoides*.
- XXXVI. *Cheilobranchius rufus*.  
*Crepidogaster spatula*.  
*Diplocrepis parvipinnis*,  
 " *cardinalis*,  
*Blennius tasmanianus*.  
*Ophioclinus gabrieli*.  
 " *gracilis*.
- XXXVII. *Monilea oleacea*.  
*Rissoa floccifera*.  
*Bathytoma agnata*.  
*Cerithiopsis caecumiatum*.  
*Pleurotoma casearia*.  
*Murex licinus*  
*Emarginula superba*.  
*Terebra lauretana*.
- XXXVIII. *Butium fuscocapitulum*.  
*Cancellaria scobina*.  
*Tiberia nitidula*.  
*Limopsis erectus*.  
*Poromya undosa*.  
*Amusium thetidis*.
- XXXIX. *Carcharias brachyurus*.
- XL. *Catulus aialis*, egg-case.
- XLI. *Parascyllium collare*, egg-case.

## PART IV.

- XLII-XLIV. Flint Implements from Aboriginal Workshops.
- XLV. Views of the principal sandhill at Bellambi.
- XLVI-XLVII. Oligochaeta from Mt. Kosciusko, N.S.W.
- XLVIII-LII. Orthoclase. New England, N.S.W.
- LIII. Radiolaria of the Tasman Sea.
- LIV-LVI. Mollusca from eighty fathoms off Narrabeen.

## PART V.

- LVII-LXII. Lower Cretaceous Fossils from the Barcoo, Ward, and Nive Rivers, South Central Queensland.
- LXIII-LXV. Fishes and Crustaceans from eight hundred fathoms.
- LXVI-LXVII. Mollusca from eight hundred fathoms, thirty-five miles East of Sydney.
- LXVIII LXXIV. North Queensland Ethnography.
- LXXV. Cassiterite.
- LXXVI-LXXVII. Cerussite.
- LXXVIII Barite, Monazite, Scheelite, Vesuvianite and Heulandite;
- LXXIX-LXXX. Chabazite.



## CORRECTIONS.

---

Page 34, in description of text figure—for “*b*” read “*B*.”

„ 83, line 7—for “and” read “with.”

„ 92, line 16—for “anhrydrous” read “anhydrous.”

„ 134, line 14—for “orthogonal” read “orthographic.”

„ 256, footnote—for “portion” read “position.”

„ 367, line 18—for “off” read “of.”

„ 390, line 21—for “born” read “borne.”

„ 393, line 18—for “dessionication” read “desiccation.”

„ 404, line 18—for “the faint line” read “a faint line.”

Plate xx. explanation line 7 add o (112).

„ xxvii.—read xxviii.

Plates xlii., xliii., xlv., at foot of plate—for “H. Barnes, Junr., read “T. Whitelegge.”

Plate liii.—substitute the plate inserted in part 5 for that previously issued in part 4, on which the figure numbers were omitted.

„ lxxii. explanation—for “Rosewell” read “Russell.”

lxxii explanation—for “dessionication” read “desiccation.”



12351

# RECORDS

OF THE

# AUSTRALIAN MUSEUM.

EDITED BY THE CURATOR.

---

Vol. VI, No. 1.

---

PRINTED BY ORDER OF THE TRUSTEES

R. ETHERIDGE, JUNR., J.P.,

*Curator.*

SYDNEY, 15TH JUNE, 1905.

## CONTENTS.

	PAGE.
The Breeding habits of the Paradise Fish. By Edgar R. Waite, F.L.S., Zoologist	1
Description of the Mutilated Cranium of a large Fish from the Lower Cretaceous of Queensland. By R. Etheridge, Junr., Curator	5
Studies in Australian Araneidæ No. 4. By W. J. Rainbow, F.L.S., F.E.S., Entomologist	9
An Addition to the Lacertilian Fauna of the Solomon Islands. By Edgar R. Waite, F.L.S., Zoologist	13
The Further Discovery of Dugong Bones on the Coast of New South Wales. By R. Etheridge, Junr., Curator	17
On an Insular Form of <i>Melithreptus brevirostris</i> , Vigors and Horsfield. By Alfred J. North, C.M.Z.S., C.M.B.O.U., Ornithologist	20
Notes on the Architecture, Nesting Habits, and Life Histories of Australian Araneidæ, based on Specimens in the Australian Museum. By W. J. Rainbow, F.L.S., F.E.S., Entomologist	22
Notes on the Varied Honey-Eater. By Alfred J. North, C.M.Z.S., C.M.B.O.U., Ornithologist	29
Opal Pseudomorphs from White Cliffs, N.S.W. By C. Anderson, M.A., B.Sc., Mineralogist to the Australian Museum, and H. Stanley Jevons, M.A., B.Sc., Lecturer on Mineralogy and Petrology, University of Sydney	31
Occasional Notes.—	
I. Climbing Habits of an Australian Snake. By Edgar R. Waite, F.L.S., Zoologist	38
II. <i>Pseudaphritis urvillii</i> , Cuv. & Val., a Fish new to Western New South Wales. By Edgar R. Waite, F.L.S., Zoologist	38



THE BREEDING HABITS OF THE PARADISE FISH,  
(*POLYACANTHUS OPERCULARIS*, *Linnaeus*).

By EDGAR R. WAITE, F.L.S., Zoologist.

In a former paper<sup>1</sup> I described the nesting habits of the Fighting Fish (*Betta pugnax*, Cantor) as observed in my aquaria. I have since had the good fortune to secure a number of living specimens of the Paradise or Rainbow Fish, *Polyacanthus opercularis*, Linnaeus,<sup>2</sup> which name, according to Dr. Boulenger,<sup>3</sup> represents the original species whence the domestic *Macropodus viridianus*, Lacépède,<sup>4</sup> is derived.

This fish is breeding very freely with me, but as its life history is well known I do not propose to do more than point out in what respects its habits differ from those of *Betta*.

The male is larger than the female, has the fins more produced and the caudal filamentous. Ordinarily the coloration of the sexes is similar, but when breeding the hues of the male are intensified, while the female becomes very pale and loses the beautiful greenish blue bars on the body. None of the illustrations I have seen do justice to this beautiful fish. My specimens exhibit ten bars as described by Linnaeus; published figures show a smaller number.<sup>5</sup>

The nest of *Polyacanthus* is usually not so extensive nor so dome-shaped as that of *Betta*: this may be accounted for by the former fish showing a greater preference for nesting beneath some shelter, as the leaf of a Nardoo (*Marsilea*) or the crossing ribbons of *Valisneria*. The first batch of eggs is frequently produced when but a few bubbles are formed, others being added below as oviposition proceeds. As a consequence the eggs are raised quite out of the water and hatched in this situation. The young ones may be seen wriggling within the egg on the surface of the nest: this lends support to the observation that some existing shelter is used, beneath which the bubbles are blown, otherwise the young would be very conspicuous to an enemy above.

---

<sup>1</sup> Waite—Rec. Aust. Mus., v., 1904, p. 293, pl. xxxviii.

<sup>2</sup> Linnaeus—Syst. Nat., ed. x, 1758, p. 283.

<sup>3</sup> Boulenger—Cambridge Nat. Hist., vii., 1904, p. 669.

<sup>4</sup> Lacépède—Hist. Nat. Poiss., iii., 1802, p. 417.

<sup>5</sup> Cuvier et Valenciennes—Hist. Nat. Poiss., vii., 1831, pl. 197; Valenciennes—Reg. Anim. Ill. Poiss., pl. lxxiv., fig. 2; Pouchet—Rev. Mag. Zool., xxiii., 1872, pl. xxv.

A marked difference is observable in the relative specific gravity of the eggs of *Betta* and *Polyacanthus*. As previously described those of the former are heavier than water, and the male collects them as they sink and places them beneath the nest. In the latter the eggs are lighter than water, and thus ascend to beneath the bubbles without the aid of the male. At the moment of extrusion the female is quite inverted, so that the eggs, apart from their relative lightness, are directed upwards. As the nest may be of but little extent, say, at first, of the size of a shilling, the eggs frequently rise to the surface in the clear water beyond its margin; these are collected by the male and placed beneath the bubbles. This does not, however, occur until some little time after the eggs are produced, for, unlike the condition in *Betta*, it is the male who is most exhausted, the female being the first to move away.

The female Paradise Fish seems to have greater motherly instinct than the female *Betta*, and frequently takes part in collecting the eggs and placing them in the "cradle," though this is quite subject to the whim of the male, who assumes complete control.

I now have eight pairs of *Polyacanthus* breeding, and there is much difference in the amount of toleration extended to the female by their respective mates. Though I had three nestings of *Betta* the progeny was the result of but one pair, so that my generalisations in this respect may not be quite fair. The female *Betta* certainly devoured all eggs and young that came within her reach. One of the female *Polyacanthus*, on the other hand, obtained three or four eggs from the nest, evidently with the view, like the male, of rearranging their position. She was, however, driven away, but at the first opportunity returned the eggs to the nest, having had them in her mouth for more than a minute.

As I had so many pairs breeding I could afford to sacrifice one family in order to ascertain, if possible, what real object the male has in so zealously tending and guarding the eggs. To this end, as soon as a complement of eggs was produced I removed them *en masse*, by means of a tablespoon, to another vessel. They hatched in the usual course, and the larvæ developed, so that now, at the end of six weeks, they are as large, active and healthy as those left under the care of the male.

With the view of ascertaining the function of the bubbles, I removed from another nest some of the newly-deposited eggs, and carefully rejected all bubbles. As before, these eggs developed equally with those left under paternal care. It would seem,

therefore, that the purport of the nest and care of the parent is simply protective. The mass of spume hides the eggs or young from aerial or terrestrial enemies, while the attendance and vigilance of the male secures them from attack of aquatic foes.

In *Betta*, whose habits are, apparently, more highly specialised, the nest must have a more important function, seeing that without it, and the care of the male, the eggs would naturally sink and doubtless perish.

I had not hitherto numbered *Utricularia* among my aquatic plants, but having procured a spray, I placed it in a vessel in my study at the museum: this contained a pair of Paradise Fish and fry a few days old. Paying me a visit next day, my colleague, Mr. T. Whitelegge, warned me of the possible fate of the young, having in mind the well-known carnivorous habit of the Bladderwort.

An inspection of the vessel showed that the number of young had very seriously diminished, and the missing ones were found in the bladders of the plant. Some were seized by the head, and some by the tail, as originally described by Mr. Simms in the case of roach fry.

In the hope of seeing a fish actually caught, my assistant, Mr. A. R. McCulloch, watched the plant, and had scarcely seated himself at the aquarium before he called me. I saw one of the fry caught by the extreme tip of the tail. It had been swimming close to one of the bladders, and possibly touched the mouth, when instantly it was trapped. At intervals its struggles were frantic, and the bladder was shaken by the vibrations. At the end of seven minutes the tail was entirely engulfed, and continued to wriggle within the bladder, while the head and body were shaken without.

The little fish lived for an hour and a half, but it was not until the following morning that the whole was taken into the bladder.

Articles dealing with the carnivorous habit of *Utricularia* are very numerous. The following refer especially to its piscivorous practice:—

Moseley (Simms)—*Nature*, xxx., 1884, p. 81.

Simms—*Loc. cit.*, p. 295, figs. 1-3.

Halpérine—*Bull. U.S. Fish. Comm.*, v., 1885, p. 353, pls. i., ii.

The housing of the fry has provided an interesting example of the principle detailed by Semper<sup>6</sup> as to the influence of the volume of water on the growth of an individual.

---

<sup>6</sup> Semper—*Animal Life*, 1881, p. 159, *et seq.*

In order to study the development of the young, I removed as I thought, the whole of a young family from a large aquarium, where they had been bred, to a small vessel at the Museum.

I afterwards discovered that five young ones had escaped my search and remained in the original aquarium. These grew at a rapid rate, whereas those placed in the smaller vessel showed no increase at all. So marked was the difference that I took one of the former from my home and placed it with its smaller brethren. It appeared as a veritable giant among them, and had all its fins properly differentiated, whereas in the others they had not developed beyond the larval stage.

To say that the later-introduced fish is twice the length and four or five times the bulk of the others may give some idea of its relative size, but its greater development may be better appreciated when I mention that it took to feeding on the smaller fish, so that now, after a partnership of about three weeks, it is the sole vertebrate occupant of the vessel.

As regards food, this fish may be said to have had what Semper calls its optimum, and yet about the time it assimilated the last of its companions it was noticeably inferior in size to the other four with which it was previously associated, though *they* had not been so lavishly supplied with food. They had, however, abundance of water. The removal of the fry placed the volume of water for the individual also at its optimum, so that now it appears to have regained its ratio of development. Thus Semper's conclusions receive interesting confirmation.

I may mention that we have had a tadpole of one of the *Hylidæ* in a small body of water for over a year; it has grown to a large size, but has never got beyond the larval stage. Other larvæ left in the pond, whence this was removed, completed their metamorphoses months ago.

DESCRIPTION OF THE MUTILATED CRANIUM OF A  
LARGE FISH, FROM THE LOWER CRETACEOUS OF  
QUEENSLAND.

BY R. ETHERIDGE, JUNR., Curator

(Plates i.—ii.)

A comparatively recent visit to Queensland yielded to Mr. P. G. Black's researches in the Lower Cretaceous beds at Marathon, Flinders River, the mutilated skull of a fish. A reproduction of this fossil has been made for the Museum collection, with Mr. Black's permission, the original returning to his cabinet.

The skull is crushed from above downward, and consequently expanded to some extent laterally, and also pressed backwards. Above, the bones are firmly encased in the close-grained argillaceous limestone forming the matrix, but below are weathered to a great extent free of the latter. The displacement arising from this downward and backward pressure renders the determination of the osseous members of the cranium difficult and uncertain; but the jaws are in a much better state of preservation. A preliminary inspection shows considerable portions of the maxillaries, and mandibles *in situ*, parts of the opercular apparatus, the hyoid bones, the pectoral fins, some of the anterior vertebrae, and remains of some ribs.

Photographs of this head were forwarded to Dr. A. Smith Woodward, who has been good enough to afford me some valuable suggestions as to its affinity. In correspondence, I indicated the genus *Portheus*, Cope, a species of which is believed to exist in the Lower Cretaceous of Queensland, but Dr. Woodward suggested *Elopopsis*, Heckel, as a more fitting resting-place. As, however, the teeth are implanted in sockets, and not merely attached to the margins of the jaws,<sup>1</sup> I have rejected this reference in favour of one that appears to me to suit the case better. In the Ichthyodectidæ (Crook), the margins of the jaws bear a row of strong, conical teeth implanted in sockets,<sup>2</sup> and the maxillæ

---

<sup>1</sup> At least, so I infer from Dr. A. Smith Woodward's remarks (Brit. Mus. Cat. Foss. Fishes, pt. 4, 1901, p. 8); see also J. J. Heckel—Denks. K. K. Akad. Wiss. (Math. Nat. Classe), xi., 1 Abth., 1856, p. 251.

<sup>2</sup> Zittel—Text-Book Pal. (Ed. Eastman), ii, 1902, p. 95.

are long and stout. Within this family we meet with two genera, *Portheus*, Cope,<sup>3</sup> and *Ichthyodectes*, Cope,<sup>4</sup> the latter of which appears to possess stronger affinities with our fossil. In the first of these, the maxillary and dentary teeth are large but of variable size, but in the latter the teeth are of uniform proportion. Furthermore, in our fossil the vertebral centra bear lateral longitudinal pits, and not mere ridges, as in *Elopopsis*.<sup>5</sup>

In its present depressed condition, the skull measures seven and a half inches, whilst the transverse width across the combined maxillæ and dentaries is three inches.

The maxillæ (*m.*) are stout bones approximately four and a half inches long, but are not perfect anteriorly. The premaxilla has disappeared, leaving a large, open space between the anterior ends of the maxillæ. The dentaries (*de.*), in consequence of compression, are overlapped by the maxillæ, and are stout and strong, approximately five inches long, by five-eighths of an inch deep, with deeply V-shaped posterior ends for the insertion of the articulators (*ar.*); the latter are stout bones also, in keeping with the dentaries, and are about two and a quarter inches long. The superior bones of the skull, in common with the orbits, are so crushed together that an attempt to distinguish them can result only in provisional determination, but perhaps, on the right side parts of the ethmoid and frontal (*eth. & f.*) are represented by the crushed mass of osseous matter seen above the maxilla. Immediately behind the gape is a curved transverse bone that may be a portion of the hyomandibular or preoperculum (*hm. pr.*), and behind that again, particularly on the right side, a flat exfoliated bone, which cannot be other than the operculum (*op.*). From this obliquely inwards to the middle line of the head, is a thick prominent surface (*p.g.*), but thinly-covered with bone here and there, and again repeated on the left side. The two halves form between them a wide open V-shaped figure, casting a deep shadow over the depression in which the vertebræ lie; possibly this represents some portion of the pectoral girdle.

Between the dentaries (*de.*) at their posterior ends may be seen the diverging hyoids (*hy.*), and a number of the branchiostegal rays (*br.*), the anterior vertebræ (*v.*), some ribs (*r.*), and the sup-

---

<sup>3</sup> Cope—Rept. U.S. Geol. Survey Territories (Hayden's), ii., 1875, p. 190.

<sup>4</sup> Cope—*Loc. cit.*, p. 205. By Woodward both these genera are placed in the Chirocentridæ (Brit. Mus. Cat. Foss. Fishes, pt. 4, 1901, p. 87), and by Dr. G. A. Boulenger in the Saurodontidæ (Cambridge Nat. Hist., vii., Fishes, 1904, p. 561).

<sup>5</sup> Smith Woodward—Brit. Mus. Cat. Foss. Fishes, pt. 4, 1901, pp. 9 and 99.

posed pectoral fins (*f.*). Of the branchiostegal rays there are portions of nine protruding through the matrix on the right-hand side, and a less number on the left. There are ten anterior vertebræ partially weathered out, occupying a length of four and a half inches, but as the four posterior have slid slightly from their normal position, the actual fore-and-aft space occupied by the series of ten will be rather less. The normal anterior vertebræ are from five-sixteenths of an inch to three-eighths in length, and all bear defined rims at both ends, and pits, almost round on the second and third from the front, but more oval in a fore-and-aft direction on the succeeding centra. The ribs are long and moderately stout, no trace of neural arches remaining. At the sides of the vertebræ, but separated from them by matrix, are roughened bony surfaces of some extent, which my colleague, Mr. E. R. Waite, suggests may be the larger basal joints of the pectoral fins compressed together and transversely displaced. Teeth are visible on both maxillæ, but not on the dentaries in consequence of the overlapping of the former over the latter, except at their immediate fractured anterior ends; at these points one tooth is visible on either side. The teeth are strong, hollow, and conical, and not compressed to a sharp edge, extending along the whole length of the maxillæ as far as these bones are preserved, and set in alveoli. The remains of about twenty-four are visible on the right maxilla and about fifteen on the left. The single teeth preserved at the anterior fractured ends of the dentaries do not appear to differ in size or character from those along the maxillæ.

The vertebræ closely resemble those figured by Dr. A. Smith Woodward "as possibly referable to [his] *Cladocyclus sweeti*,"<sup>6</sup> a species dependant on certain detached scales from the Lower Cretaceous of Queensland. Dr. Woodward has also figured the left lateral view of the anterior portion of a skull from the same series of rocks as *Porthenus australis*,<sup>7</sup> to which the present fossil bears a very suspicious resemblance. In the light of Cope's type figure of the cranium of *Porthenus*,<sup>8</sup> and his remarks on the teeth—"Sizes irregular; the premaxilla, median maxilla, and anterior dentary teeth much enlarged"<sup>9</sup>—there is a possibility of Dr. Woodward's fish being an *Ichthyodectes* also. In the figure of *Porthenus australis*

<sup>6</sup> Woodward—Ann. Mag. Nat. Hist., (6), xiv., 1894, pl. x., f. 7.

<sup>7</sup> Woodward—*Loc. cit.*, pl. x., f. 1, 1a.

<sup>8</sup> Cope—Report U. S. Geol. Survey Territories (Hayden's), ii, 1875, p. 184, f. 8, pls. xxxix and xli (*P. molossus*).

<sup>9</sup> Cope—Report U.S. Geol. Survey Territories (Hayden's), ii, 1875, p. 190.

there is no greater degree of variation in the size of the teeth than there is in those of our fossil. The maxillæ and dentaries in both are large bones, although larger in *P. australis*, whilst in *Ichthyodectes marathonensis*, as I purpose terming Mr. Black's specimen, the space left by the accidental removal of the pre-maxilla, would accommodate nearly as large a bone as that represented in the figure of that of *P. australis*.

If my selection of *Ichthyodectes* be correct, *I. marathonensis* resembles *I. ctenodon*, Cope,<sup>10</sup> in possessing straight maxillæ, and apparently similar dentaries also. *I. ctenodon*, in common with *I. anaides*, Cope,<sup>11</sup> is a much larger fish, and the bones are certainly more massive. With *I. serridens*, Sm. Woodw.,<sup>12</sup> *I. tenuidens*, Sm. Woodw.,<sup>13</sup> *I. minor* (Egerton), Newton,<sup>14</sup> and *I. elegans*, Newton,<sup>15</sup> hardly any comparison is necessary. In *I. hamatus*, Cope,<sup>16</sup> the maxillæ are again much curved.

<sup>10</sup> Cope—*Loc. cit.*, pl. xlvi., f. 1 and 2.

<sup>11</sup> Cope—*Loc. cit.*, pl. xlv., f. 1.

<sup>12</sup> Smith Woodward—*Brit. Mus. Cat. Foss. Fishes*, pt. 4, 1901, pl. viii.

<sup>13</sup> Smith Woodward—*Loc. cit.*, pl. ix., f. 6.

<sup>14</sup> Newton—*Quart. Journ. Geol. Soc.*, xxxiii., 1877, pl. xxii., f. 14.

Newton—*Loc. cit.*, pl. xxii., f. 15.

<sup>16</sup> Cope—*Report U.S. Geol. Survey Territories (Hayden's)*, ii., 1875, pl. xlv., f. 5, 5a.



STUDIES IN AUSTRALIAN ARANEIDÆ.

No. 4.

By W. J. RAINBOW, F.L.S., F.E.S., Entomologist.

(Plate iii. and text fig. 1).

Family DICTYNIDÆ.

Genus AMAUROBIUS, *C. Koch.*

AMAUROBIUS SOCIALIS,<sup>1</sup> *sp. nov.*

♀ Cephalothorax, 5·5 mm. long, 3·5 mm. broad; abdomen, 6·1 mm. long, 4·2 mm. broad.

*Cephalothorax*.—Obovate, dark brown, hairy. *Pars cephalica* large, strongly arched. *Pars thoracica* broad, sloping posteriorly, arched, median depression and normal grooves distinct.

*Eyes*.—Eight, disposed in two transverse, nearly parallel rows, and occupying almost the entire space in front: front row almost straight, rear row gently recurved. Of the front row the median pair are very slightly the largest, and are placed closely together, nearly touching one another; each lateral eye is separated from its median neighbour by a space equal to once its own diameter; those comprising the rear row are slightly smaller than their anterior neighbours; the median pair are separated from each other by a space equal to about twice their individual diameter, and from their lateral neighbours by about two and a half diameters.

*Legs*.—Robust, yellow-brown, clothed with long hairs, and armed with strong spines. Measurements (in millimetres):—

---

<sup>1</sup> *Socialis*—Social, sociable.

Leg.	Coxa.	Trochanter and Femur.	Patella and Tibia.	Metatarsus and Tarsus.	Total.
1	1.1	4.4	4.4	3.8	13.7
2	1.1	4.4	4.4	3.8	13.7
3	1.0	3.6	3.6	3.4	11.6
4	1.0	4.2	4.3	3.8	13.3

*Palpi*.—Concolorous, short, similar in clothing and armature to legs. Measurements: Coxa, 0.4 mm.; trochanter and femur, 1.8 mm.; patella and tibia, 1.8 mm.; tarsus, 1.3 mm.; total, 5.3 mm.

*Falces*.—Dark brown, long, robust, arched, hairy, margins of the furrow of each falx armed with three teeth.

*Maxille*.—Longer than broad, robust, arched, inclining inwards, hairy, the surface dark brown, apices and inner angles pale yellowish.

*Labium*.—Concolorous, longer than broad, hairy, apex truncated.

*Sternum*.—Concolorous also, shield-shaped, convex, hairy.

*Abdomen*.—Ovate, moderately overhanging base of cephalothorax, hairy, yellow-brown, with faintly-visible broad transverse bars, the first three of which are straight, or nearly so, whilst the lower pair are each formed like a short, broad, inverted V; below these, again, there is a large concolorous elongate-oval patch. Laterally and beneath, the surface is hairy, and yellow-brown.



Fig. 1.

*Epigyne*.—As in figure (fig. 1).

*Cribellum*.—Transverse, nearly parallel, and divided into two plates.

*Obs*.—In gravid females, the abdomen appears much lighter in colour.

*Hab*.—Grand Arch, Jenolan Caves.

Some time ago, Mr. J. C. Wiburd presented to the Trustees two large shawl-like webs, taken from the roof of the Grand Arch, Jenolan Caves. Each web was closely and densely-woven, and had been fabricated by a large number of individuals living

together as a community. No spiders were forwarded with the first example, but from its folds I picked a quantity of *exuvæ*, which convinced me that the architects belonged to the genus *Amaurobicus*, C. Koch. I thereupon wrote Mr. Wiburd—who has on different occasions presented the Trustees valuable Arachnological collections from the Cave districts—asking him to try and secure some of the spiders responsible for the construction. This he succeeded in doing, so that I am now enabled to describe both the spider and the web.

The larger web presented by Mr. Wiburd measures twelve feet in length, and rather more than four feet at its greatest width, and when hanging *in situ* was festooned amongst the stalactites depending from the roof of the cave. The webs are full of holes, each of which had evidently been the entrance to a retreat tube. These webs are closely and densely woven, and are suggestive of a fabric—such as a shawl. Scattered over the surface of this huge web are a large number of empty cocoons, or ova-sacs. These are pure white, flat, more or less discoidal and closely woven. Each sac consists of two strong, paper-like discs—an upper and a lower—between which the eggs had been placed. None exhibited any trace of loose, flocculent silk. The discs do not appear to vary in size. A number were measured, and from seven to eight millimetres in diameter was the result obtained.

#### *Family* CECOBIIDÆ.

In my last paper of this series, I recorded for the first time in Australia the occurrence of the family *Mimetidæ*.<sup>2</sup> The present paper records, also for the first time here, the family *Cecobiidæ*. The family is a very small one, consisting of only one genus, and fifteen species. The genus *Cecobius*, Lucas, is distributed over “Regio mediterranea; ins. Atlanticæ; Arabia merid.; Japonia; Nova Caledonia; America septent. et merid.; Antillæ,”<sup>3</sup> to which I now add—Sydney, N. S. Wales.

The species occurring here appears to be, unquestionably, the widely distributed *C. navus*, Bl. This form has been previously recorded from the islands of the Atlantic, Japan, New Caledonia, Venezuela, southern parts of the United States, and the Antilles. This distribution Simon suggests is, without doubt, due to the agency of commerce.

---

<sup>2</sup> Rainbow—Rec. Austr. Mus., v., 1904, p. 329.

<sup>3</sup> Simon—Hist. Nat. des Araignées, 2nd Ed., i., 1892, p. 247.

The species are all microscopic. Their webs, which are also small, are closely woven and transparent, and are usually constructed under stones, and in the angles of walls. When at rest in the web, these spiders hang motionless, but when disturbed they are decidedly active, and in endeavouring to escape describe circles. Their cocoons are flocculent, rather transparent, plano-convex, fixed, and contain each seven or eight non-agglutinated eggs.

There are three specimens in the Australian Museum cabinet and they were collected by myself in the Museum building.

AN ADDITION TO THE LACERTILIAN FAUNA OF THE  
SOLOMON ISLANDS.

BY EDGAR R. WAITE, F.L.S., Zoologist.

(Fig. 2).

The Trustees have received a fine female Gecko from Mr. Charles M. Woodford, British Resident, Solomon Group.

Mr. Woodford's knowledge of the fauna of the group under his administration led him to suggest that the Gecko was an undescribed species; though previously known, it indeed proves to be new to the Solomon Islands. This is the more interesting as the group has been so well worked by Messrs. Guppy and Woodford. In this connection Dr. G. A. Boulenger remarks<sup>1</sup>:—"The fact that, in spite of the extent of the collection (over 200 specimens) and the special attention paid by the collector [Mr. Woodford] to this group of animals, only four species are thereby added to the herpetological list of the Solomons, shows that our knowledge of this part of the fauna approaches completion." In the paper quoted Boulenger gives a complete list (28) of the reptiles of the Solomon Group, to the date of publication. Several species have, however, been added since that time, and it is now my privilege to add another.

Mr. Woodford's Gecko proves to be:—

GYMNODACTYLUS LOUISIADENSIS, *De Vis*.

Ann. Rep. Brit. New Guinea, App. cc., 1892, p. 5, and Ann. Queensland Mus., ii., 1892, p. 11.

The type was obtained at Sudest Is. (Tagula Is.) Louisiade Archipelago. A species from Moroka, British New Guinea, was described and figured by Boulenger<sup>2</sup> under the name *G. loriv*. Dr. Franz Werner<sup>3</sup> thoroughly reviewed these two forms and inclined to the belief that they are not specifically distinct. For present purposes I assume this to be so. Mr. Woodford's specimen, however, seems to be a typical example, differing from the type only in respect to arrangement of the colour bands, in having the internasal plates broken up into four, and the subdigital lamellæ and labial plates slightly different in number,

<sup>1</sup> Boulenger—Proc. Zool. Soc., 1888, p. 88.

<sup>2</sup> Boulenger—Ann. Mus. Civ. Sto. Nat. Genova, (2), xviii., 1897 (1898), p. 695, pl. vi.

<sup>3</sup> Werner—Verh. Zool.-bot. Ges. Wien, li., 1901, p. 604.

In 1901 Mr. Samuel Garman<sup>4</sup> reported on the reptiles of Mr. Alexander Agassiz's Expedition to the Barrier Reef, and described a member of the genus *Gymnodactylus* under the name *G. olivii*. He contrasts its characters with those of *G. pelagicus* and evidently did not consult the descriptions of *G. louisianensis* or *G. loriae*. *G. olivii* is certainly identical with our specimen, agreeing with it in the disposition of the colour bands which, as above mentioned, differ somewhat from those of the type.

In *G. louisianensis* there are but five body bands, the first of which, connecting the eyes across the occiput, is V-shaped; the disposition of the other bands is not mentioned, but their arrangement is probably similar to those of *G. loriae*. In this form there are three pairs of markings between the fore and hind limbs, and a fifth at the base of the tail. The markings are not in the form of bands, but consist of pairs of oblique streaks, each pair forming a V-like figure, those only of the nape and the base of the tail, however, produce a complete V.

In both Mr. Garman's and Mr. Woodford's examples the bands are six in number; the first is U-shaped, the second connects the shoulders, three occupy the space between the fore and hind limbs, and the sixth connects the thighs, having a much more anterior position than the last band in *G. louisianensis* or *G. loriae*. These bands are incomplete below.

Of Dr. Werner's adult examples, one resembled *G. louisianensis* the other *G. loriae*, while a young one exhibited eight pairs of spots or streaks. This author particularly refers to structural details, tabulated below, the characters of *G. olivii* and Mr. Woodford's specimens being now included.

Name.	Lamellæ under 4th toe.	Supralabials.	Rows of body tubercles.
<i>G. louisianensis</i> ...	10-11	12	26
<i>G. loriae</i> ...	—	12	—
Dr. Werner, i. ...	18	14-15	26
, ii. ...	12	17-18	28
, iii. ...	12	11-13	22
<i>G. olivii</i> ...	—	13	24
Mr. Woodford ...	12	13	26

<sup>4</sup> Garman—Bull. Mus. Comp. Zool. Harv. Coll., xxxix., 1901, p. i., pl. i., fig. 1.

In both examples which have been figured (*G. lorie* and *G. olivii*), the tail has been reproduced, and as usual in such cases the colour-pattern and distinctive scutation of the original member is lost. In our example the tail has not suffered mutation and opportunity is taken to illustrate its character. It is covered with flat juxtaposed scales which are smallest above, increasing in size towards the lower surface; those bordering the large inferior scutes are quite one-third the width of the scutes. The tubercles upon the upper and lateral aspects of the proximal portion, as far as the hinder edge of the first caudal colour band, are similar to those of the body; thence the arrangement assumes a distinctive character, the tubercles being confined to the upper surface and disposed in widely spaced transverse rows. Of these the first three are composed each of six tubercles, the two in front having a supplementary row of four tubercles anteriorly; the next five rows are formed each of four tubercles and the three following of two each only, the latter of which is but little differentiated from the ordinary scales. The tubercles occupy the proximal three-sevenths of the tail only.



Fig. 2.

As on the body, the markings are in the form of bands though of darker hue, and similarly they do not compass the lower surface. The colour increases in intensity posteriorly and the distal two-fifths is without markings. There are five dark bands on the tail, each twice the width of the interspaces, and on the median line above they are deeply incised before and behind. The accompanying figure (fig. 2) illustrates the features described.

The type was, as before stated, taken at Sudest Is. in the Louisiades, and the British Museum possesses examples from Fergusson Is., Woodlark Is., and British New Guinea. From the latter locality the types of *G. lorie* were obtained, Dr. Werner had three specimens from Dutch New Guinea, and Mr. Garman's *G. olivii* is recorded from Cooktown. Mr. Woodford

informs us that his example was taken in the chart drawer at the Government Residence, and that he has since seen another specimen about the grounds. During a subsequent conversation with Mr. Woodford, in Sydney, he told me that when disturbed this Gecko walks very high upon its legs, and curves its tail over its back in a menacing manner. The Queensland locality must, I think, be accepted with some reservation; Cooktown is the port of call for vessels trading to New Guinea, the Louisiades and the Solomon Group and it seems highly probable that the Lizard was obtained by some trader and taken to Cooktown, whence it passed into the hands of Mr. Agassiz's collectors. Further evidence will be required of the occurrence of this species in Australia before it will be safe to admit it as an undoubted member of our fauna.

On March 19th, more than two months after the above was penned, I received a letter from Mr. E. A. C. Olive: he writes:—"I have your letter of February 3rd with sketch of reptile enclosed. I think I must have obtained the original from New Guinea, as I do not recognise it as one of our local lizards, and I remember receiving a variety of specimens from that place."



THE FURTHER DISCOVERY OF DUGONG BONES  
ON THE COAST OF NEW SOUTH WALES.

By R. ETHERIDGE, JUNR., Curator.

(Plate iv.)

For an opportunity of again recording the occurrence of bones of the Dugong (*Halicore dugong*, Gmelin, sp.) on the coast of New South Wales, I am indebted to Mr. P. E. Williams, Comptroller of the Government Savings Bank, and Secretary to the Sydney Ethnological Committee.

During the excavation of Shea's Creek, Cook River, Botany Bay, for the canal bearing the same name, portions of a Dugong skeleton were discovered near the top of the estuarine clay, and just above the extensive estuarine shell bed which is so marked a stratigraphical feature in the alluvial section laid bare by the canal cutting. "They were five feet six inches to eight feet six inches below the present high-water level, and a total depth of four feet six inches to seven feet six inches below the swamp surface level, previous to excavation."<sup>1</sup> The bones recovered were vertebrae, ribs, and the nearly perfect skull. It was pointed out by Messrs. T. W. E. David, J. W. Grimshaw, and the writer, that the present southerly limit of the Dugong is probably Wide Bay, on the Queensland coast, although it was formerly to be caught in Moreton Bay.<sup>2</sup> Only two reliable records of the

---

<sup>1</sup> Etheridge, David, and Grimshaw—Journ. Roy. Soc. N.S. Wales, xxx 1896, p. 171.

<sup>2</sup> I have since learned that the Dugong is still caught in Moreton Bay. Mr. C. Hedley has called my attention to a footnote in Britton and Bladon's "History of New South Wales" (ii., 1894, p. 97) quoting a paragraph from Collins, which reads as follows:—"About this time (March, 1795), the spirit of inquiry being on foot, Mr. Cummings, an officer of the Corps, made an excursion to the southward of Botany Bay, and brought back with him some of the head bones of a marine animal, which on inspection Captain [William] Patterson the only naturalist in the country, pronounced to have belonged to the animal described by M. de Buffon, and named by him the Manatee (Collins—Acc. English Colony N.S.W., 1st Ed., l. p. 409.)" The wording in the second edition differs slightly. If for Manatee we read Dugong we have confirmatory evidence of the Shea's Creek occurrence, and at a slightly more southern locality.

Dugong's presence on the coast of New South Wales, *i.e.*, further south than either of those mentioned, are extant, *viz.*, at the Tweed and Richmond Rivers<sup>3</sup>, and Broken Bay, immediately to the north of Port Jackson.<sup>4</sup>

The chief point of interest in connection with these bones from Shea's Creek was the presence of transverse and oblique curved cuts and scars, particularly on the ribs at their outer or distal ends, as if produced by a blunt-edged cutting or chopping instrument. No doubt whatever was entertained by my co-writers and myself that such was the origin of these markings. The fact was used as corroborative evidence, pointing to the occupancy of this part of the coast by man at a much earlier date than previously supposed. It was felt at the time that any additional facts relating to the Dugong's presence so far below its usual haunts would be most welcome.

The fortunate discovery of Dugong bones by Mr. C. A. Rudder in a large kitchen-midden on "Arakoon" at the entrance of the Macleay River, supplies the needed evidence. The midden in question lay about one and a-half miles from the ocean and was in course of removal for the construction of oyster beds. It consisted of shells, black sand, and stones with oysters attached, in diameter about thirty feet, and seven feet in thickness. The bones found near the bottom of the midden are four rib pieces, portion of a large worn molar tooth, and a rib of a seal. Three rib pieces exhibit traces of hacking. Like the ribs found at Shea's Creek, one of the Arakoon bones is deeply scarred and cut by some blunt instrument, in fact even more so than either of those from the metropolitan locality, and a second, the most perfect rib (Plate iv., fig. 2), less so. The bones still retain the solid homogenous appearance and weight characteristic of those of the Dugong; no other objects of interest were discovered during the removal of the midden material. One may infer a considerable age for the Arakoon bones from their appearance, so much so that the markings on the most complete rib have nearly disappeared, but not so with the two smaller portions. At the thicker end of one of the latter (Pl. iv., fig. 1) are several deep sub-parallel cuts lengthwise, united in places by cross-hacking, and at the other end, one or more pieces of bone have been chipped off

---

<sup>3</sup> Ransay—Cat. N.S. Wales Court Gt. Internat. Fisheries Exhib. Lond., 1883, p. 50.

<sup>4</sup> Etheridge, David, and Grimshaw—Journ. Roy. Soc. N.S. Wales, xxx., 1896, p. 172.

the surface, but still leaving traces of sharper blows. On the other (Pl. iv., fig. 3), the scars are confined to the centre of the bone and are transverse to its length.

The occurrence of these hacked bones at the Macleay River adds corroborative evidence of the use of the Dugong as food by the old Aborigines just as it is now partaken of by their descendants further north, and adds another record of the animal's presence on a part of the eastern coast-line not now frequented by it. This case may be accepted as an example of the good results likely to arise by a systematic examination of our coast middens before they have totally disappeared through the agency of modern man. The importance of midden exploration cannot be too forcibly impressed on those who may have facilities for such work. It is only through the excavation of similar heaps, the examination of interments, the exploration of the hearth-refuse heaps of rock-shelters, and the opening up of ossiferous caves that we can now hope to learn much about the habits and manners of the earlier inhabitants of this Continent.

ON AN INSULAR FORM OF *MELITHREPTUS*  
*BREVIROSTRIS*, Vigors AND HORSFIELD.

By ALFRED J. NORTH, C.M.Z.S., C.M.B.O.U., Ornithologist.

*Melithreptus magnirostris*, sp. nov.

(Plate v., figs. 1-2.)

Being at present engaged on the *Meliphagidæ* for the next part of "Nests and Eggs of Birds found breeding in Australia and Tasmania," among other species, Mr. A. Zietz, the Assistant Director of the South Australian Museum, Adelaide, has kindly drawn my attention to three skins of which he writes—"You will notice three specimens of *Melithreptus brevirostris* with remarkably strong bills; the birds were shot on the 3rd October, 1901, by my son Mr. F. R. Zietz out of a flock at Eastern Cove, Kangaroo Island. This might be an insular form of the mainland species."

On the head and nape these specimens, two adult males, and an adult female, more closely resemble New South Wales examples of *Melithreptus brevirostris*, the forehead and crown being of a lighter brown, and the dull buffy-white and blackish-brown bands on the nape being but slightly indicated in comparison with South Australian specimens; they resemble the latter in having a dull white loreal streak but which is even more pronounced; the cheeks and sides of the throat of an adult male are dull white, which passes into a very faint creamy buff on the remainder of the under surface, darker on the centre of the breast and abdomen, the centre of the throat and the fore-neck having a greyish tinge, the flanks slightly washed with brown. The bills of all three specimens are distinctly larger than in continental examples. The adult male previously referred to measures—total length 5·3 inches, wing 2·75, tail 2·4, tarsus 0·65, exposed portion of bill from base of forehead where the feathers end to tip 0·55, breadth of cutting edge at centre of nostril 0·19, height of bill at centre of nostril 0·19.

*Remarks.*—The outer secondaries of the type are externally edged with olive, as is also found in some adult New South Wales specimens. The white cheek stripe of the specimen labelled a

female is shorter, the under surface is more distinctly tinged with brown, and the wing measurement is 2·8 inches. There is only a slight indication of the white cheek stripe in the other male. Wing measurement, 2·75 inches. The bill of the type is measured as are the bills of all the specimens in the already quoted Catalogue from the end of the feathers at the base of the forehead to the tip, with a pair of finely-pointed calipers irrespective of any curve of the culmen.

*Types*.—To be placed in the South Australian Museum, Adelaide.

*Co-type*.—Australian Museum, Sydney.

*Habitat*.—Kangaroo Island, South Australia.

These birds with the larger bills constitute a well-defined and apparently constant insular form, which I propose in contradistinction to specifically distinguish under the name of *Melithreptus magnirostris*, the Large-billed Honey-eater.

The figures in the accompanying plate are of the natural size, and are reproduced from a photograph of two bird skins laid side by side. One is of an adult male of *Melithreptus brevirostris*, FIG. and HORSE., from the collection of the South Australian Museum, Adelaide, procured by Dr. A. M. Morgan at Laura, South Australia; the other of the type, an adult male, of *Melithreptus magnirostris*, obtained by Mr. F. R. Zietz on Kangaroo Island.

NOTES ON THE ARCHITECTURE, NESTING HABITS, AND  
LIFE HISTORIES OF AUSTRALIAN ARANEIDÆ, BASED  
ON SPECIMENS IN THE AUSTRALIAN MUSEUM.

BY W. J. RAINBOW, F.L.S., F.E.S., Entomologist.

(Fig. 3.)

PART V.—**ENTELEGYNÆ** (*continued*).

FAMILY PHOLCIDÆ.

The genus *Pholcus*, Walck., was erected by C. Koch, in 1850, to family rank.<sup>1</sup> Prior to this date, it had been included in the family Theridiidæ. Simon, in his masterly work,<sup>2</sup> has defined its position, and to this the student is referred.

The family Pholcidæ has since been divided into two sub-families—the Pholcinæ and Ninetidinæ. With the first of these, twenty genera are now associated, of which three occur in Australia; the second embraces only one (*Vinctis*, Sim.), and its habitat is defined as “Arabia felix.”<sup>3</sup>

The genus *Artema*, Walck., has a wide range, its distribution being: “Africa tota; Arabia; Asia occid., centr. et merid.; Malaisia et Polynesia; America antillana et merid.”<sup>4</sup> This being so, it is quite possible that it may hereafter be recorded from the Australian region.

The genus *Pholcus*, Walck., is exceedingly ubiquitous, its range being: “Orbis utriusque reg. calid. et temp.”<sup>5</sup> Only one species—*P. litoralis*, L. K.—is known to me as occurring in Australia. It has been recorded from Rockhampton and Brisbane, and is very common in the neighbourhood of Sydney, where it is known popularly as “Daddy Longlegs.”

The Pholcidæ are of sedentary habits, and are most frequently met with in buildings, where they construct their webs in the angles of walls and ceilings. Their snares are irregularly constructed, the lines comprising them being drawn in every conceivable direction. The Pholcidæ have been formed into a group under the name of Filitèles, from their habit of spinning long filaments of silk whenever or wherever they move. When an insect

---

<sup>1</sup> C. Koch—Ueb. Ar. Syst., v., 1850, p. 31.

<sup>2</sup> Simon—Hist. Nat. des Araignées, 2nd Ed., i., 1892, p. 456.

<sup>3</sup> Simon—Loc. cit., p. 487.

<sup>4</sup> Simon—Loc. cit., p. 466.

<sup>5</sup> Simon—Loc. cit., p. 471.

is captured in the web of one of these spiders, the owner immediately shakes the snare violently in order to secure its prey. When irritated or disturbed they will gyrate round and round most rapidly, usually describing circles from right to left. When resting in the web, they invariably hang body downwards, as illustrated in the figure (fig. 3); occasionally they may be detected resting in a vertical position, in which case the usual posture is head downwards. The eggs are held together in an agglutinated spherical mass; sometimes they are covered with silk.

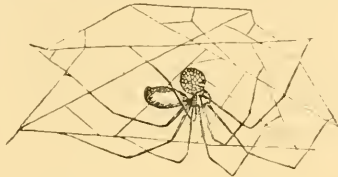

Fig. 3, *Pholcus litoralis*, L. K.

The female carries the mass of ova with the falces, and always approximated to her sternum; nor will she for one moment relinquish her burden until the spiderlings have hatched out. The eggs included in the spherical mass are numerous, and are usually of a whitish-yellow tint.

These spiders may sometimes be collected from under overhanging rocks, in rock-shelters, and in the hollows of trees.

In 1877, Mr. H. B. Bradley erected the genus *Micromerys*, for the reception of a species collected by the "Chevert" Expedition at Cape York. The genus, however, is widely distributed. Simon gives its geographical area as "Africa occid.; ins. Madagascar (*madagascarensis*, E. Sim.); ins. Philippinæ (*vermiciformis*, E. Sim.); Nova-Hollandia septr. (*gracilis*, Bradl.); America trop.; Venezuela (*conica*, E. Sim., etc.)."<sup>6</sup>

*M. gracilis*, Bradl., is long and cylindrical, being about 8 mm. long and 1 mm. broad, with excessively long and thin legs.

*Psilochorus*, Sim., occurs in "America sept. et merid.: India orient.; Oceana."<sup>7</sup> In this genus also, only one species is known to occur in Australia—*P. sphaeroides*, L. K. It was placed by its author in the genus *Pholcus*, but Simon has removed it to *Psilochorus*. This species occurs at Rockhampton. Nothing has been recorded of its life habits.

#### FAMILY THERIDIIDÆ.

This family includes upwards of seventy genera, and an immense number of species. Of the genera recorded at least a dozen are known to occur in Australia, and one in Tasmania. These spiders are also sedentary, and form a group by themselves

<sup>6</sup> Simon—*Loc. cit.*, p. 474.

<sup>7</sup> Simon—*Loc. cit.*, p. 482.

—the Retitæles, spiders which form webs with open meshes and irregular chambers, and which lurk in the centre or at their sides.

Individually considered, the members of this family are small, the largest being those of the genus *Latrodectus*, Walck.—spiders having a somewhat evil reputation.

Many of the species are remarkable for their bright and striking colours, as well as interesting and curious forms. All—or nearly all—sedentary spiders construct webs for the capture of prey, and these are of two distinct types—(1) the irregularly-formed snare, or *retitelarian* web: and (2) the wheel-like, or *orbicular* web. The first of these is characteristic of the Theridiidæ.

Morphologically, this family is a most interesting one. It has been studied by many authors, no two of whom are wholly in accord as to its classification, while some are absolutely at variance. The reader who desires to pursue the subject further should carefully peruse Simon's remarks on this family.<sup>8</sup>

In order, however, to satisfactorily study this group, it would be necessary not only to bring together an extensive collection, but to devote possibly years to patient and laborious investigation. Simon found he could not satisfactorily divide this family into sub-families, but in order to facilitate its study he broke it up into about eighteen groups, of which six occur on the mainland of Australia and one in Tasmania.

#### ARGYRODEÆ.

This group embraces three genera, each of which is widely distributed. They are *Ariannes*, Thor., *Rhomphaea*, L. K., and *Argyrodes*, Sim. The range of the first of these is defined as "Orbis reg. tropic. omn.;"<sup>9</sup> and of the second and third, "Orbis totius reg. trop. et sub-trop."<sup>10</sup> *Ariannes* and *Argyrodes* each occur in Australia.

*Ariannes colubrinus*, Keys., was originally recorded from Peak Downs, but I have had it from various parts of this State. Mr. A. M. Lea collected it in the Northern Rivers District, and I have collected it at Guildford and Waterfall. It is a long, vermiform spider, and constructs a small web amongst the branchlets or spurs of shrubs and coarse herbage. When disturbed or alarmed it drops out of its web and hangs suspended by a thin silken line. Owing to its colour, and the manner in which it folds its legs when dangling in the air, it has the appearance of a piece of dead stick hanging on a web.

<sup>8</sup> Simon—*Loc. cit.*, pp. 488, *et seq.*

<sup>9</sup> Simon—*Loc. cit.*, p. 502.

<sup>10</sup> Simon—*Loc. cit.*, pp. 502 and 503.



The spiders of the genus *Argyrodes* are small, and many of them exceedingly brilliant, looking, when suspended in their webs, like atoms of burnished silver, or dewdrops glistening in the sun. In habits they are parasitic, and usually construct their irregular webs among the outer lines of the snares of large orb-weavers such as *Cryptophora*, Sim., and *Nephila*, Leach. Their food consists of the smaller insects that have become entangled in the huge orb-webs, and which are too minute to attract the attention of the legitimate tenant. *A. antipodiana*, Cambr., occurs both in New Zealand and Australia. I have collected specimens around Sydney in the autumn. *A. incisifrons*, Keys., has been recorded from Bowen and Sydney; and Mr. Lea collected *A. margaritarius*, mihi, at the Clarence River, N. S. Wales.

#### EPISINÆ.

Nine genera are included in this group, two of which, *Episimus*, Latr., and *Janulus*, Thor., occur in Australia. The spiders of the former genus are, according to Simon, "walking Theridiides," and are most frequently met with outside their webs. All these spiders are of striking form. The first, second, and fourth pairs of legs are long, and the third pair very short. The abdomen is usually rhomboidal, wide and high in front, and attenuated behind. The genus occurs in "Europa et reg. medit.; Asia centr.; ins. Taprobane; Africa austr.; N. Hollandia (*australis*, Keyserl.); N. Zealandia (*antipodiana*, Cambr.); America sept. et merid.; Venezuela, Brasilia, Paraguay."<sup>11</sup> Keyserling's species, *E. australis*, originally recorded from Peak Downs, is the only form so far recorded from Australia.

The genus *Janulus*, Thor. (of which our Australian form, *J. bicornis*, Thor., is the type species), is recorded from "ins. Taprobane; pen. Malayana; N. Hollandia sept.; America merid.; Antilla, Venezuela, Brasilia."<sup>12</sup> Although so widely distributed, only a dozen species have, so far, been assigned to this genus. *J. bicornis* is at present unknown to me; the type was collected by D'Albertis, at Somerset, Cape York.

#### EUROPEÆ.

There are six genera in this section, three of which occur in Australia. The first of the Australian series, *Euryopis*, Menge, is widely distributed, its range being: "Europa et reg. medit.; Asia centr., merid. et orient; Nova-Hollandia et Polyn.; Ameri. sept. et merid."<sup>13</sup> Only one species occurs in Australia—*E. um-*

<sup>11</sup> Simon—*Loc. cit.*, p. 520.

<sup>12</sup> Simon—*Loc. cit.*, p. 521.

<sup>13</sup> Simon—*Loc. cit.*, p. 529.

*bilicata*, L. K. This species is widely distributed. I have seen specimens from many localities. Koch's type specimen came from Port Mackay. The species is common around Sydney, and may be collected all the year round. It lurks under stones, or almost any refuse lying upon the ground, under which it may rest in security. When disturbed it rushes off in quest of shelter with great rapidity. It constructs a small web, consisting of a few lines, but this is useless for the capture of prey. I have often sought, and in vain, for the ova-sac.

*Diaprocaraus*, Sim., is recorded from "Nova-Hollandia merid."<sup>14</sup> This contains only one species, *D. multipunctatus*, Sim., from "Nova-Hollandia merid.," and it is unknown to me.

*Phylarchus*, Sim., contains six species. The range of this genus is "Asia centr.; ins. Taprobane; ins. Philippinæ; N.-Hollandia; N.-Caledonia."<sup>15</sup> *P. splendens*, Sim. (= *Euryopsis elegans*, Keys.), occurs in Australia and New Caledonia. Keyserling's type came from Peak Downs. This species has the same habit as *E. umbilicata*.

#### THERIDIÆ.

The spiders of this group are distinctly sedentary. They are to be found inside buildings, in caves, under rock-shelters, on the spurs and branches of shrubs and trees, and sometimes on the trunks of trees. Their reticularian snares are of indeterminate form, and are composed of brilliant threads, which cross each other at every conceivable angle. The cocoons are, as a general rule, globose in form, rarely elongate. They are composed of a tough, silken tissue, closely woven and opaque; the outer and inner walls have a somewhat woolly appearance. The colour varies: some are white, some yellowish, some brown, and some are of a dull greyish tint. With few exceptions, the cocoons are attached to and suspended from the web. *Theridion bimaculatum*, Linn., and *Theridula*, spp., are recorded by Simon as carrying their ova-sacs attached to their spinnerets, in exactly the same manner as those of the genus *Lycosa*, Latr. Those species which suspend their cocoons to the web, usually construct three or four, or even more, and these are generally placed close to each other; but those which carry their ova-sacs make only one. Each ova-sac contains an immense number of eggs. In addition to being sedentary, the Theridiæ are, as a rule, solitary. *Theridion eximium*, Keys., of South America, is a social species, many individuals living together, each uniting its web to that of its neighbour, the whole thus making, apparently, one large, comprehensive snare.

<sup>14</sup> Simon—*Loc. cit.*, p. 529.

<sup>15</sup> Simon—*Loc. cit.*, p. 529.

Ten genera have been assigned by Simon to this group, and of these one occurs in Australia, namely, *Theridion*, Walck. This genus is widely distributed, its geographical area being: "Orbis totius reg. calid., temper. et frigid."<sup>16</sup> Some of the species associated with it are also ubiquitous, for instance, *T. rufipes*, Lucas, and *T. tepidariorum*, C. Koch. The latter is common around Sydney, and sometimes invades buildings. It occurs in Europe, Africa, Asia, and America. The snare constructed is large and usually dome-shaped, and the lines of which it is composed, although exceedingly fine, are nevertheless strong enough to arrest large insects. Some of the victims, if there be too many for the owner's immediate needs, are carried to the upper part of the web, and enswathed with silk. The ova-sacs are more or less round, and are usually of a reddish-brown tint.

The genus *Theridion* is one of the most numerous of the entire order. Koch has recorded ten species from Australia in his standard work.<sup>17</sup> One of the species, *T. albo-striatum*, L. K., is widely distributed, and occurs not only on our Australian mainland, but also in the South Pacific Islands. Keyserling, in the supplement to Koch's monograph,<sup>18</sup> records four others, all of which appear to be peculiar to Australia.

#### PHORONCIDÆ.

The Phoronciidæ includes some very striking and grotesque forms. The abdomen is large, and in some species, such as *Phoroncidia*, Westw., armed with long, strong spines. This genus does not occur in Australia, so far as we know at present, but seeing that its geographical area is "India et ins. Taprobane; Malasia et Papuasias; ins. Madagascar; Africa trop. occid.,"<sup>19</sup> we may certainly expect it to occur in Northern or Tropical Australia.

*Ulesanis*, L. K., is distributed over "Reg. medit. occid.; Africa trop. orient. et Afr. austr.; ins. Taprobane; ins. Philippinæ; N. Hollandia, N. Zealandia et Polynesia; Amer. sept., trop. et austr."<sup>20</sup> Six species of this genus are recorded from Australia and Polynesia. *U. scutuberculata*, Keys., occurs in Queensland, where it was originally recorded from Gayndah; it is also found in the Richmond River District. These spiders are usually found on shrubs or bushes, where they construct their reticularian snares.

<sup>16</sup> Simon—*Loc. cit.*, p. 550.

<sup>17</sup> L. Koch—*Die Arachniden Australiens*, i., 1871, p. 256, *et seq.*

<sup>18</sup> Keyserling—*Die Arachniden Australiens*, Suppl., 1890, pp. 241, *et seq.*

<sup>19</sup> Simon—*Loc. cit.*, p. 561.

<sup>20</sup> Simon—*Loc. cit.*, p. 560.

## DIPENEE.

This is a small group, consisting of three genera, only one of which occurs in Australia, namely *Latrodectus*, Walck. The range of this genus is "Orbis totius reg. trop. et sub-trop."<sup>21</sup> For this genus Thorell described what he supposed to be two distinct Australian species—*L. hasseltii* and *L. scelio*.<sup>22</sup> They are, however, synonymous, and *hasseltii* must be accepted as the specific name.

*L. hasseltii* is widely distributed throughout India, Malaysia, Papua, Australia, New Zealand, and Polynesia. The Indian form (*L. hasseltii* var. *indicus*, Sim.) has been recorded by Simon from Arabia.<sup>23</sup> In Australia it is known as the "Venomous Spider," and in New Zealand by the Maori name "Katipo, which is said to mean "night-stinger." In respect of the bite and its effects, the matter is at present under investigation, and will be dealt with on a future occasion.

The webs of this species are established in all sorts of dark corners, in old and empty cans, or amongst any loose rubbish; they also occur under stones and rock shelters.

The snare is of the usual reticularian type, somewhat dome-shaped: the lines are very strong, and are capable of arresting large and powerful beetles. The cocoons are yellow, closely-knitted, somewhat woolly in appearance, and each encloses a large number of eggs. The inner walls have much the same appearance as the outer. A large number of cocoons are made, and these are always suspended together.

## ASAGENEÆ.

This is a group of stridulating Theridions. It is remarkable that of the ten genera referred to it by Simon—some of which are most widely distributed—none are known to occur on the mainland of Australia. There is only one genus which may be considered as part of our fauna, namely, *Ancocelus*, Sim., of Tasmania, and that has only one species—*A. livens*, Sim. This genus is most nearly allied to the European and American *Steatoda*, Sund. The Tasmanian species is unknown to me.

<sup>21</sup> Simon—*Loc. cit.*, p. 569.

<sup>22</sup> Thorell—*Aranea nonnullæ Nova Hollandia*, in *Öfv. Kongl. Vet.-Akad. Forhandl.*, 1870, 4, p. 369; also Koch—*Die Arachniden Australiens*, i., 1871, pp. 276 and 279.

<sup>23</sup> Simon—*Bull. Mus. Hist. Nat.*, 1897, 3, p. 95; and 1902, 4, p. 252.

NOTES ON THE VARIED HONEY-EATER  
(*PTILOTIS VERSICOLOR*, GOULD.)

By ALFRED J. NORTH, C.M.Z.S., C.M.B.O.U., Ornithologist.

*Ptilotis versicolor*, North, Vict. Nat., xxi., 1905, p. 167.

(Plate v., fig. 3.)

The Varied Honey-eater was described by Gould in 1842 from a single specimen contained in a collection of bird skins from Northern Australia, and was for many years regarded as a rare species. It is an inhabitant of the coastal districts and adjacent islands of Northern and North-eastern Queensland and Southern New Guinea, and is also found on some of the intermediate islands of Torres Strait. Off the coast of North-eastern Queensland, MacGillivray obtained this species on Dunk Island, and Elsey on Albany Island. Many specimens were procured by the "Chevert" Expedition, fitted out by the late Sir William Macleay, since when it has been obtained by various collectors both in New Guinea and Australia.

Among a small collection of bird skins sent me for examination, made by Mr. Albert F. Smith, principally near Cairns, North-eastern Queensland, and the neighbourhood, was a specimen of *Ptilotis versicolor*, Gould, collected by him on one of the Frankland Islands on the 16th October, 1904. Subsequently I received a second specimen from him, shot in company with the other, also their nest and a set of two eggs taken at the same time.

The nest of *Ptilotis versicolor*, as will be seen from the accompanying plate, is an open cup-shape, and somewhat scanty structure, daylight being visible through the greater portion of the sides. Externally it is formed of fibrous rootlets, held together with plant down and spider webs, with which are intermingled a few egg-bags of spiders and their green silky covering, the inside being sparingly lined with fine pale brown rootlets and fibre, and at the bottom with a small quantity of silky-white plant-down. It is attached by the rim on one side to a leafy horizontal branch from which springs a thin twig at right angles, but this is concealed in the structure, two leaves being worked on to the side of the nest. Externally it measures three inches and three-quarters in diameter by two inches and a quarter in depth, the inner cup measuring three inches in diameter by one inch and a half in depth.

The eggs, which were in an advanced state of incubation, are two in number, oval in form somewhat pointed at the smaller end, the shell being close-grained, smooth and lustrous. They are of a uniform fleshy-buff colour, being of a slightly richer shade on the larger end, where on one specimen, with the aid of a lens, a few very minute darker dots may be seen. The eggs of this species are indistinguishable in colour from a variety of those of its close ally *Ptilotis sonora*, Gould, also from those of the Pallid Cuckoo (*Cuculus pallidus*, Latham).

Relative to taking the above nest and set of eggs, Mr. Smith has kindly supplied me with the following notes:—"This species is fairly plentiful on one of the Frankland Islands off the coast of north-eastern Queensland. It has a loud call that attracted my attention as our boat drew near the island, as something quite different to anything I had heard before, but cannot describe it at all. There is a shrub with a number of thin upright leafy twigs which grows over half the island, and it was in one of these about ten yards from the beach the nest was built. It was seven feet from the ground, and attached to thin upright twigs on one side, and the horizontal branch on the other side which remains fastened to the nest. It contained two eggs very much incubated, and while I was taking them the pair of birds perched on a tree alongside and uttered their loud cries. I brought both down with one shot without damaging either as specimens."

OPAL PSEUDOMORPHS FROM WHITE CLIFFS,  
NEW SOUTH WALES.

By C. ANDERSON, M.A., B.Sc., Mineralogist to the Australian Museum, and H. STANLEY JEVONS, M.A., B.Sc., late Lecturer on Mineralogy and Petrology, University of Sydney.

(Plates vi—vii., text fig. 4).

The occurrence of Opal at White Cliffs as pseudomorphic crystals, called locally "fossil pineapples" has been known for some time; they have been described by several observers, but no agreement has yet been reached as to the species of the original mineral. Recently several good specimens have reached Sydney and were examined by Professor T. W. E. David and the authors, the conclusions arrived at being set forth in the present paper.

*Occurrence.*—Before proceeding to the description of the specimens themselves, their mode of occurrence, so far as known to us, may be briefly alluded to. The White Cliffs Opal-field was first geologically examined in detail by Mr. J. B. Jaquet, and it is chiefly to his report<sup>1</sup> that we must turn for our knowledge. The opal is found in the Upper Cretaceous or "Desert Sandstone" Series, which at White Cliffs rests on Palaeozoic slates of probably Silurian age. Overlying the Palaeozoic strata are (*d*) coarse grits and sandstones, succeeded by (*c*) a thickness of fine white, kaolin-like material of highly siliceous composition and containing large waterworn boulders of quartzite with Devonian fossils. Concretionary nodules, and more rarely thin beds of gypsum occur in these deposits. Above this are (*b*) conglomerates consisting of small pebbles in a white siliceous matrix similar to *c*. It is in the beds *b* and *c* that the opal occurs. It is often found replacing various organic remains as Sauropterygian bones, Crinoid calices, stems, and separate ossicles, Belemnite guards and bivalve and univalve shells, as well as coniferous wood<sup>2</sup>.

---

<sup>1</sup> Jaquet—Ann. Rept. Dept. Mines and Agric. N. S. Wales, 1892 (1893), pp. 140—142.

<sup>2</sup> Etheridge—Rec. Austr. Mus., iii., 2, 1897, p. 19; Mem. Geol. Surv. N. S. Wales, Pal. No. 11, 1902, p. 10; Rec. Austr. Mus., v., 4, 1904, pp. 248, 251; *loc. cit.*, v., 5, 1904, pp. 306-316.

Pittman—Min. Res. N. S. Wales, 1901, p. 405.

Tate—Trans. Roy. Soc. S. Austr., xxii., 1898, p. 77.

The presence of Crinoids indicates an open fairly deep sea, whilst the conglomerates, boulders, opalised saurians and wood rather point to shallow water conditions with land at no great distance. In the absence of exact knowledge as to the vertical distribution of these fossils, it is idle to speculate on the geographical conditions obtaining at the time when the beds containing these enigmatical specimens were laid down. The presence of gypsum is not conclusive, for gypsum may originate either as a chemical deposit in an inland sea, or salt lake, or, on the other hand, may be formed subsequently to the deposition of the beds in which it occurs, for example by the action of decomposing pyrites on calcareous matter. According to Prof. J. D. Dana<sup>3</sup> where gypsum occurs not as continuous layers but in embedded, nodular masses, it was formed after the beds were deposited. This criterion does not help us to a conclusion, for Mr. Jaquet says<sup>4</sup> that the gypsum occurs both as isolated masses and as thin beds. In the recent surface deposits of the western districts of New South Wales gypsum is commonly met with as crystalline masses, where it is undoubtedly of secondary origin and due to chemical interaction between the constituents of the soil, and it is possible that a similar origin is to be assigned to the gypsum found in the opal-bearing beds. Against the likelihood of the gypsum being the result of evaporation in a land-locked sea is the comparative abundance of organic remains, for, when the water of an enclosed basin has reached a degree of concentration that permits of the deposition of gypsum from solution, animal life is usually absent. But it is conceivable that a temporary lake may have been formed as a remnant of a retreating ocean, and then subsequently re-united to the waters of the Cretaceous sea. Any solution of the problem presented by the pseudomorphs must be compatible with the presence of gypsum in the same beds.

Both gypsum and the mineral now known to us only as opaline casts have been converted into opal, the former partially, the latter entirely, by the action of highly silicated springs to which the general opalisation of the Desert Sandstone is usually attributed.

*Previous Observers.*—The pseudomorphs were apparently first observed by Jaquet,<sup>5</sup> by whom they were referred probably to

---

<sup>3</sup> Dana—Manual of Geology, 4th ed., 1895, p. 554.

<sup>4</sup> Jaquet—*Loc. cit.*, p. 141.

<sup>5</sup> Jaquet—*Loc. cit.*, p. 141.



gypsum. Later Weisbach<sup>6</sup> measured the angles and came to the conclusion that the original mineral was orthorhombic in system; he suggested sulphur. He was followed by Pelikan<sup>7</sup>, who compared them to aggregates of gypsum crystals. Gürich<sup>8</sup> gives a more detailed account and concludes that the original mineral was monoclinic and probably identical with the original of the well-known "barley-corn" pseudomorphs from Sangerhausen, and similar pseudomorphs from elsewhere. But even if this conclusion be justified it does not settle the question, for at least five minerals have been suggested as the original of the Sangerhausen and similar specimens, celestite, perhaps, being regarded as the most likely,<sup>9</sup>

*Description of Specimens.*—The material for this paper was furnished by two specimens in the collection of the Geological Department, Sydney University, and five from the Australian Museum collection. That represented in Pl. vi., fig. 1, is the largest and best developed, hence it has supplied the bulk of the angular measurements by the contact goniometer. Unfortunately it is found that the angles vary somewhat, thus giving an element of uncertainty to the conclusions drawn therefrom; yet, by making a large number of measurements and taking means, it is hoped that a fair approximation has been made to the true angles.

The seven specimens vary in their greatest diameter from 11 cm. to 7.5 cm. approximately. They present a fairly uniform appearance, which is that of an irregular, radial aggregate of acute, tapering, four-sided pyramids. Owing to the curvature of the faces it is scarcely possible to secure exact measurements of the angles, though an attempt was made to counteract this source of error by making the goniometer arms tangent to the part of the faces close to the edges. An important feature in most of the pseudomorphic crystals is the well-marked cleavage (Pl. vi., fig. 2). It generally crosses one only of the four terminal edges, but sometimes passes over the apex and appears, though less strongly

<sup>6</sup> Weisbach—*Neues Jahrb.*, ii., 1898, p. 150.

<sup>7</sup> Pelikan—*Tschermak's Min. petr. Mitth.*, xix., 1900, p. 336.

<sup>8</sup> Gürich—*Neues Jahrb.*, Beil. Bd., xiv., 1901, pp. 478-483, fig.

<sup>9</sup> Dana—*Bull. U.S. Geol. Surv.*, 12, 1884, pp. 25-28; *Syst. Mineral.* 6th Ed., 1892, pp. 271, 907.

Miers—*Min. Mag.*, xi., 1897, p. 264.

marked, on the opposite edge. In direction it is approximately parallel to the plane of two opposite edges, namely the plane bisecting the angles  $bq$  and  $pd$  (fig. 4). There is no sign of a second cleavage perpendicular to this plane. Three systems of striations are present, but they will be more fully described below.

As regards their composition, the pseudomorphs consist of precious opal of inferior quality and prevailing green or bluish tints, in other cases of common milky opal, or of clear glassy hyalite, with patches of the rarer black opal.

Measurements were made as a rule by each of us independently, but the agreement being close, only the mean values are given in the subjoined table. Provisional letters are assigned to the four

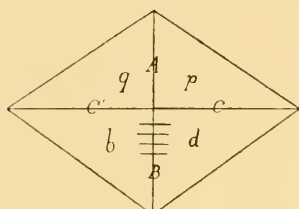

Fig. 4.

Schematic projection on a plane at right angles to the axis of elongation, with cleavage traces on edge  $b$ .

pyramidal faces, the crystal being oriented by means of the edge on which the cleavage appears (fig. 4). The mean normal angles obtained plainly indicate that we are dealing with a monoclinic mineral having a plane of symmetry bisecting the angles  $bd$  and  $pq$ .

*Conclusions.*—The problem now is to find a mineral, monoclinic in symmetry, having a prominent cleavage perpendicular to the plane of symmetry, with angles approaching the values found, and the mode of occurrence of which is compatible with the geological conditions of the White Cliffs Upper Cretaceous beds. Obviously the facts of form already brought out dispose of the claims of gypsum, anhydrite, celestite and sulphur, while the angles do not even approximate to those of gaylussite. After passing in review all the likely minerals that suggest themselves, we have come to the conclusion that the species most nearly fulfilling the required conditions is glauberite, sulphate of soda and lime, which is monoclinic in crystallisation, and has a perfect basal cleavage. In accordance with this theory, we have incorporated in the table the theoretical angles of glauberite, which we regard as corresponding to the measured angles of the pseudomorphs.

Pseudomorphic Crystals.										Glauberite.			
Normal Angles.	I	II	III	IV	V	VI	VII	VIII	Mean.	Normal Angles.	Indices.	Approximate.	Calculated.
	°	°	°	°	°	°	°	°	°			°	°
$p \wedge q$	64	68	62	$62\frac{3}{4}$	$68\frac{1}{2}$	65	67	$64\frac{1}{4}$	65	$s \wedge s'$	$111 \wedge \bar{1}11$	$63\frac{3}{4}$	63 42
$b \wedge d$	84	89	92	$80\frac{1}{2}$	$82\frac{1}{2}$	85		86 $\frac{1}{4}$	$85\frac{1}{2}$	$o'' \wedge o'''$	$\bar{1}\bar{1}\bar{1} \wedge 111$	87	87 7 $\frac{1}{2}$
$p \wedge d$	75	79	81	$83\frac{1}{2}$	82	84	79	76	80	$s \wedge o''''$	$111 \wedge 11\bar{1}$	76	75 58
$q \wedge b$	88	$78\frac{1}{2}$	82	$[92\frac{1}{2}]$	78	80	78	78	80	$s' \wedge o''$	$\bar{1}\bar{1}\bar{1} \wedge 1\bar{1}\bar{1}$	76	75 58

If we are correct in regarding these specimens as pseudomorphs after glauberite, the original crystals must have been acute pyramidal in habit, with elongation in the direction of the clino-axis (Pl. vii., figs. 7, 9).

As the amount of error in measurements does not exceed  $2^\circ$ , the disagreement between the values obtained for the same angle on different crystals must be due to the varying amount of curvature and imperfection of form.

We next proceeded to confirm our results, and to explain, if possible, the divergence of the measured angles from the true values by determining the terminal angles between the edges A and B, and C and C'<sup>10</sup> (fig. 4), and the terminal pyramidal angles  $sn''$  and  $s'n'''$  (using the lettering of glauberite for corresponding faces of the pseudomorphs). The results are tabulated below:—

Angles.	Measured.	No. of Determinations.	Calculated.	Error.
	o		o	o
C $\wedge$ C'	68½	10	78 42	10
A $\wedge$ B	64	4	79 13 <sup>11</sup>	15
$\left. \begin{array}{l} s \quad n'' \\ s' \quad n''' \end{array} \right\}$	50½	12	61 35 <sup>11</sup>	11

The difference between the measured and the true angles is considerable, and some explanation must be forthcoming if our conclusions are correct. Now, on several specimens it is apparent that the cleavage is not exactly parallel to the plane of the two opposite edges C and C' (fig. 1). This would be explained (assuming the original mineral to have been glauberite in which the cleavage is parallel to this plane) by a curving downward of those edges towards the cleavage. This downward curving could be accounted for by oscillatory combination of the *s* faces with a form *hkh* ( $k > h$ ). No such form is recorded in Dana, but observation reveals the presence of a set of striations on the faces *s* and *s'* running parallel to the edge A. These striations would be a natural result of such an oscillatory combination, which

<sup>10</sup> A is the edge between *s*<sub>2</sub> and *s'*<sub>2</sub>; B the edge between *n''* and *n'''*; C and C' the edges between *s* and *n'''* and *s'* and *n''* respectively.

<sup>11</sup> Taken from stereogram by Penfield's protractor.

would have the effect of displacing the edges C and C' towards the cleavage lines crossing the edge B (Pl. vii., figs. 8, 9), and also of rendering the angle CC' measured over the apex more acute (Pl. vii., figs. 2, 3). Another series of striations observed on the *s* faces of other crystals, and having a direction nearly parallel to the edges C and C' may be due to the coming in of the *m* (110) face. The *n* faces are strongly striated, and in some cases distinctly stepped, the direction of the striæ and steps being parallel to the cleavage. These must be due to oscillatory combination of *n* with C (001), or *n* with *u* (112) or *v* (113), any of which would make the angle between the edges A B more acute than it would be in a perfect crystal (Pl. vii., figs. 8, 9).

We may now enquire what effect the oscillations described would have on the normal angles. It is readily seen that by their means the normal angle *ss'* would be enlarged, and the angle *n''n'''* diminished, while the angles *sn* would be either diminished or enlarged according as the effects of the oscillation of (*hkh*) on *s* or of (001) on *n* predominate. Now, from the mean values obtained by measurement, it will be observed that the departure from theory of the angles *ss'* and *n''n'''* is in the direction we should have expected. The mean value for the angle *sn* was found to be greater than the theoretical, which accords with our observation that the oscillation on the *n* faces is frequently much more pronounced than that on the *s* faces.

Glauberite is commonly found in association with rock salt, thenardite, mirabilite, and other sulphates, carbonates, &c., characteristic of salt lake deposits. It is soluble in water, and can, therefore, occur only in protected places or in arid regions. Most likely at White Cliffs it was formed in deposits of mud or ooze and not directly from solution. The consequent interference with the regular growth of the crystals may possibly account for the curvature of the faces through oscillatory combination. It is noteworthy that with the single exception of the thinolite of Lake Lahontan all the pseudomorphs resembling the Sangerhausen mineral, as also the pyramidal crystals of celestite from Virginia described by G. H. Williams,<sup>12</sup> which furnish the chief argument for the celestite origin, have been found embedded in clay, mud or marl. Thus it may be that the resemblance between specimens from different localities, which after all consists mainly in the curved and tapering form, is to be referred rather to the similar conditions of growth than to identity of species.

<sup>12</sup> Williams—Amer. Journ. Sci., xxxix., 1890, p. 183.

## OCCASIONAL NOTES.

—:0:—

### I.—CLIMBING HABITS OF AN AUSTRALIAN SNAKE.

Mr. Percy G. Peard, of the Public School, Dalwood, New South Wales, recently forwarded some snakes for identification from the vicinity of Lismore, Richmond River.

Respecting *Hoplocephalus stephensii*, Krefft, Mr. Peard writes:—  
“ I neglected to mention, in describing the ‘ Banded specimen,’ that it was caught climbing an ironbark tree.”

This is an extremely interesting observation, and confirms any suspicion one may have had as to the use of the notched keels of the ventral plates.

When describing the species, Krefft drew attention to the similarity in structure to members of the genus *Dendrophis*. Mr. Peard’s happy remark shows that the structural peculiarity has been independently developed for tree-climbing purposes in two widely different genera of reptiles.

In future, therefore, *Hoplocephalus stephensii*, *H. bitorquatus*, and, perhaps in a lesser degree, *H. buugaroides*, should be regarded as partially arboreal in habit.

EDGAR R. WAITE.

---

### II.—*PSEUDAPHRITIS URVILLII*, CUVIER & VALENCIENNES, A FISH NEW TO WESTERN NEW SOUTH WALES.

As this fish is known from South Australia, it might naturally be assumed to occur in the western waters of our State.

Dr. C. C. Cocks, of Wentworth, Darling River, has forwarded a specimen to the Trustees for identification, remarking that it was caught by one of the oldest fishermen of the district, who had never seen its like before. To Dr. Cocks, himself an angler of

the locality for thirty years, the fish was a novelty. It was taken in the Murray River, about a quarter of a mile below its junction with the Darling River, and is a new record for our western fauna.

Originally described from Tasmania, the species is also known from South Australia, Victoria, and the southern rivers of New South Wales.

Ogilby<sup>1</sup> suggests that *Pseudaphritis urvillii* is identical with *Eleginus bursinus*, Cuvier and Valenciennes, said to have been taken in Port Jackson, in which case the name would be *Pseudaphritis bursinus*.

EDGAR R. WAITE.

---

<sup>1</sup> Ogilby—Proc. Linn. Soc. N. S. Wales, xxii., 1898, p. 560.









JUN 13 1906

12351

# RECORDS

OF THE

LIBRARY  
AUSTRALIAN MUSEUM.  
GARDENHILL, 1905

EDITED BY THE CURATOR.

---

Vol. VI., No. 2.

---

PRINTED BY ORDER OF THE TRUSTEES.

R. ETHERIDGE, JUNR., J.P.,

Curator.

SYDNEY, 15th SEPTEMBER 1905.

## CONTENTS.

	PAGE.
Mollusca from One Hundred and Eleven Fathoms, East of Cape Byron, New South Wales. By Charles Hedley, Conchologist	41
Notes on Fishes from Western Australia, No. 3. By Edgar R. Waite, F.L.S., Zoologist	55
Mineralogical Notes, No. II,—Topaz, Barite, Anglesite, Cerussite and Zircon. By C. Anderson, M.A., B.Sc., Mineralogist	83
On a Large Example of <i>Megalatractus aruanus</i> , L. By Charles Hedley, Conchologist	98
Notes on Australian Siphonaptera. By W. J. Rainbow, F.L.S., F.E.S., Entomologist	101
The Osteology of the New Guinea Turtle. By Edgar R. Waite, F.L.S., Zoologist	110
Occasional Notes—	
III. Western Australian Prawns and Sponges. By T. Whitelegge, Zoologist	119

JUN 13 1905

MOLLUSCA FROM ONE HUNDRED AND ELEVEN  
FATHOMS, EAST OF CAPE BYRON, NEW SOUTH  
WALES.

BY CHARLES HEDLEY, Conchologist.

(Figs. 5—22).

Incidental to his official duties on the Coast Survey, Mr. G. H. Halligan, L.S., Government Hydrographer, took, on the 10th of November, 1902, a haul of the dredge in 111 fathoms, at twelve and a half miles due east of Cape Byron, itself the easternmost point of Australia.

The product was at once sent to the Australian Museum for examination, but constant pressure of work has delayed an earlier report.

The contents of the dredge were mostly shells and foraminiferal sand. Accompanying these was an interesting Hydro-coralline, identified by Mr. T. Whitelegge as *Conopora tenuis*, Moseley,<sup>1</sup> hitherto known only from the Kermadec Archipelago.

Mr. H. J. Jensen has given an account of the Foraminifera obtained.<sup>2</sup>

A number of the shells discovered by the "Thetis" Expedition recur here, thereby extending their range northwards.

Omitting the pelagic shells dropped from the surface the known Mollusca taken at this station are as follows:—

- Arca reticulata*, Gmelin.
- Amusium thetidis*, Hedley.
- Bathyarca perversidens*, Hedley.
- Calyptrea calyptreaformis*, Lank.
- Cardita caratica*, Hedley.
- „ *dilecta*, Smith.
- Capulus devotus*, Hedley.
- Chione despecta*, Hedley.
- Cirsonella weldii*, Ten. Woods.

---

<sup>1</sup> Moseley—Phil. Trans. Roy. Soc., 169, 2. 1878, p. 503; Chall. Rept., Zool., ii., 1881, p. 82, pl. xii., f. 5 a, b, 6.

<sup>2</sup> Jensen—Proc. Linn. Soc. N.S. Wales, xxix., 1905, pp. 817-822.

- Crassatellites securiforme*, Hedley.  
*Crossea carinata*, Hedley.  
*Cuna particula*, Hedley.  
 „ *concentrica*, Hedley.  
*Cylostrema micron*, Ten. Woods.  
 „ *inscriptum*, Tate.  
*Cylichna protumida*, Hedley.  
*Dentalium erectum*, Sowerby.  
*Dimya corrugata*, Hedley.  
*Drillia dilecta*, Hedley.  
 „ *unia*, Hedley.  
*Emarginula dilecta*, A. Adams.  
*Eulimella turrita*, Petterd.  
*Leda miliacea*, Hedley.  
*Leiostraca loderce*, Hedley.  
*Leucotina micra*, Pritchard and Gatliff.  
*Lima bullata*, Born.  
*Limopsis teuisoni*, Ten. Woods.  
*Liotia annulata*, Ten. Woods.  
 „ *compacta*, Petterd.  
 „ *minima*, Ten. Woods.  
 „ *tasmanica*, Ten. Woods.  
*Marginella angasi*, Brazier.  
 „ *berigata*, Brazier.  
 „ *mustellina*, Angas.  
 „ *ochracea*, Angas.  
 „ *stillia*, Hedley.  
 „ *whani*, Pritchard and Gatliff.  
*Mathilda decorata*, Hedley.  
*Melanella commensalis*, Tate.  
*Mitra strangei*, Angas.  
*Oscilla ligata*, Angas.  
*Purpura sertata*, Hedley.  
*Pedicularia stylasteris*, Hedley.  
*Pseudorissoina exigua*, Hedley.  
*Rissoa oliracea*, Fraenfeld.  
*Scala minutula*, Tate and May.  
*Schismope atkinsoni*, Ten. Woods.  
*Siliquaria weldii*, Ten. Woods.  
*Sirius badius*, Ten. Woods.  
*Turbonilla raricifer*, Tate.  
*Turritella scitula*, Donald.  
*Thraciopsis arenosa*, Hedley.  
*Vermetus waitei*, Hedley.

The Brachiopoda are :—

*Liothyris ura*, Brod.

*Terebratulina radula*, Hedley.

*Megerlia willemoesi*, Davidson.

### BRACHIOPODA.

*CAMPAGES*, *gen. nov.*

A genus of the Terebratellidæ, which externally has the aspect of *Magellania*, but whose adult brachial frame has developed only to the Mühlfeldtian stage.

Type—*C. furcifera*.

*CAMPAGES FURCIFERA*, *sp. nov.*

(Figs. 5-6).

Shell rather solid, compressed at the sides, subtrigonal, broadest anteriorly, in front deeply bifurcate. Pedicle valve very deep, brachial valve lid-like. A fairly deep and broad sinus extends along the latter half of the pedicle valve. Surface smooth with fine concentric growth lines, but no radial sculpture, microscopically punctate. Colour pale yellow. Beak short, incurved. Foramen large, circular, complete. Deltidium a truncated triangle with emarginate base. Hinge teeth well-developed, placed at the base of the deltidium. Hinge plate with four rays divided by deeply incised grooves. Beneath the median groove is the

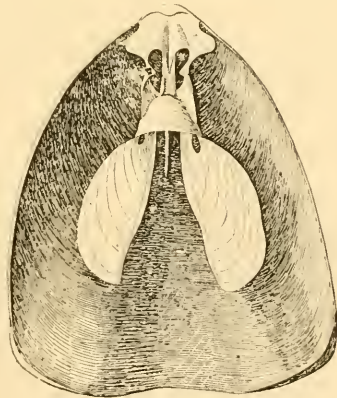

Fig. 5.  
*Campages furcifera*.

septum. From the two side grooves branches descend and converge to produce the crura; again descending and broadening, they unite on the one side to the septum and on the other form a recurved dorsal margin to the loop wings (fig. 6*a*). From the septum the brachial process arises directly. It does not here develop into the ordinary loop, but assumes the aspect of a

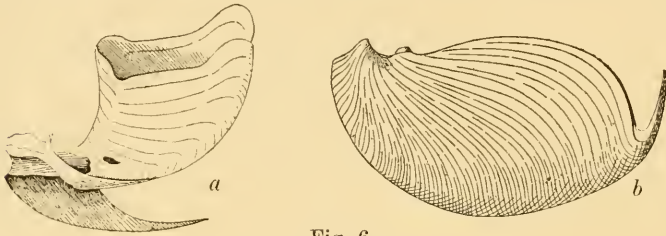

Fig. 6.  
*Campages furcifera.*

hood with large outstretched wings, narrowing posteriorly into a funnel with an open neck. Under the hood the base of each loop wing is pierced by a small rent. This structure seems to represent in adolescence that which elsewhere appears as a phase of early life.

Length—24 mm. ; breadth, 17 mm.

A single specimen attached to a stone.

*HEMITHYRIS COLURNUS*, *sp. nov.*

(Figs. 7-8).

Shell shallow, triangular-cordate, smooth except for faint growth lines, glossy, translucent though solid, pale horn colour. Edges of valves broad and bevelled.

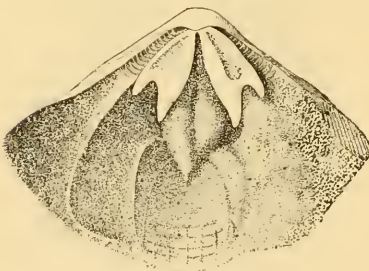

Fig. 7.  
*Hemithyris colurnus.*

The brachial valve has the beak incurved. Crural plates separate to the umbo, projecting, forked distally, furrowed along the upper surface. Teeth sockets sharply transversely grooved. There is no septum, but in old and thickened individuals a bilobed shelly mass appears in its place.

The pedicle valve has the beak produced. The small oval foramen completed by the deltidial plates. Teeth strong projecting. In front the central



third of the valve projects outward and upward into the mesial sinus of the corresponding valve; behind it is a broad shallow sinus.

Height, 18 mm.; breath, 18 mm.; depth of pedicle valve, 6 mm.

This species appears to be nearest to *H. beecheri*, Dall.,<sup>3</sup> from 313 fathoms, off Honolulu; but, so far as I can judge, ours is a broader, shallower shell, less flexed in front.

Besides its occurrence in 111 fathoms east of Cape Byron, it was taken by Mr. Halligan and myself in 100 fathoms east of Wollongong. From this parcel the type was selected. Recently it was again procured by Mr. W. F. Petterd and myself in 250 fathoms twenty three miles east of Sydney. The species

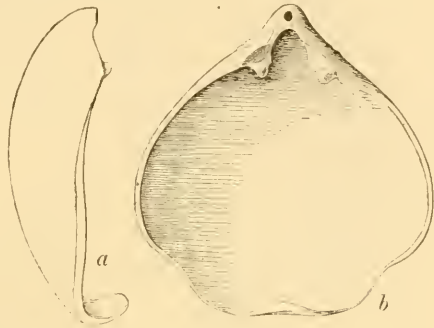

Fig. 8.

*Hemithyris colarnus*.

appears to be common, since every haul on the margin of the continental shelf has yielded single and broken valves. No perfect specimen has yet appeared.

While on the subject of the Brachiopoda, I might here notice that *Thecidea maxilla*, Hedley,<sup>4</sup> has lately been taken by Mr. D. Mawson in the New Hebrides.

## PELECYPODA.

*ADACNARCA SQUAMEA, sp. nov.*

(Fig. 9).

Shell minute, rounded-ovate, oblique inflated. Colour pale yellow. No epidermis apparent. External sculpture, faint, regular, concentric growth lines. Prodissoconch depressed at the summit, radially punctate, passing into the dissoconch without an elevated margin. Hinge line straight, exactly divided by a small chondrophore, finely perpendicularly striated. The valve edge has ventrally a broad, smooth, contact surface, like that of *Limopsis*; dorsally it carries on both anterior and posterior sides a series a

<sup>3</sup> Dall—Proc. U.S. National Museum. xvii., 1894, p. 717.

<sup>4</sup> Hedley—Austr. Mus. Mem., iii., 1899, p. 508.

interlocking tubercles, which are probably the homologues of what Bernard described as the dysodont teeth of *Philobrya*. Three or four radial grooves and complementary ridges, directed to the extreme ventral margin, which they undulate, traverse the interior,

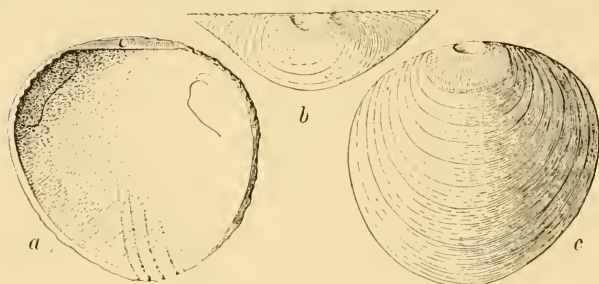

Fig. 9.

*Adacnarca squamea*.

but are not visible externally. Perhaps the interlocking tubercles aid the weak hinge by clasping the ventral margins. Pallial line indistinct. Anterior and posterior adductor scars present, situated high up. Height, 1·8; length, 1·81; depth, 0·5 mm.

The genus *Adacnarca* was formed by Prof. P. Pelseneer for the reception of a larger species taken by the Belgica Expedition.<sup>5</sup> It appears to me to belong to the sub-family Philobryinae, from the known members of which it chiefly differs by its greater symmetry. *Hochstetteria* forms a link between it and the more eccentric *Philobrya*. Some characters of *Adacnarca* suggest a more distant relation to the Limopsidae. I would prefer to range the Philobryinae rather with the Taxodonts like Pelseneer than with the Pearl shells like Bernard. Indeed an ideal sketch of the primitive Taxodont stage by H. Fischer\* would almost serve as a picture of our shell.

Prof. Paul Pelseneer has very kindly compared specimens of this with his type. He remarks (5 April, 1905) that the hinge of the Australian species is shorter, and that the two striated plateaux on either side of the ligamentary fossette are higher than in the type. These differences he regards as specific, and accepts the species for inclusion in his genus.

LIMEA ACCLINIS, *sp. nov.*

(Fig. 10).

Shell small, thin, oblique, inequilateral, subangled anteriorly, externally resembling *L. linguatula*, Lamk. Colour white. Sculpt-

<sup>5</sup> *Adacnarca nitens*, Pelseneer — Voy. "Belgica," Moll., 1903, p. 24, pl. vii., f. 83.

\* Fischer—Journ. de Conch., xlv., 1897, p. 211, f. 1.

ture of about forty narrow sharp radiating ribs, most prominent in the centre, where they strongly denticulate the margin, gradually vanishing at the sides; in the groove between each a row of minute prickles. At intervals concentric zones mark rest stages of growth. Prodissoconch smooth, sharply defined. Hinge line short, with a broad, shallow central pit, and three or four feeble teeth radiating from each end. Interior slightly grooved by external ribbing. Height, 9.6 mm.; length, 6 mm.; depth of single valve, 2.5 mm.

The thin, inequilateral shell readily distinguishes this from other Australian species which have been referred to this genus. It was also taken by Mr. Halligan and myself in 100 fathoms off Wollongong; and again recently by Mr. W. F. Petterd and myself in 300 fathoms, twenty seven and a half miles east of Port Jackson Heads. It seems a characteristic species of this zone.

CUSPIDARIA TRUNCATA, *sp. nov.*

(Fig. 11).

Shell small, thin, rather convex, trapezoidal, very inequilateral; dorsal margin straight, the length of the shell; posterior side oblique sinuate; ventral margin slightly rounded; anterior side abruptly truncate. Colour white. Sculpture, of delicate spaced lamellæ, obsolete anteriorly, developed most on the rostrum, on either side of which they form scales. Between the lamellæ are

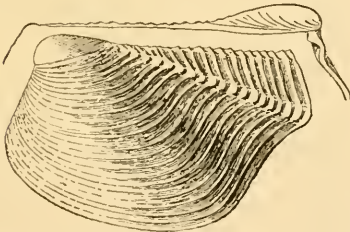

Fig. 11.

*Cuspidaria truncata.*

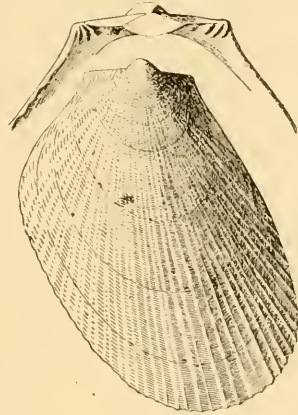

Fig. 10.

*Limea acclinus.*

fine hair lines. Rostrum blunt, short, broad, running up as a flat wedge towards the umbo. A broad, shallow furrow runs from the apex beneath the rostrum to the dorsal margin. Prodissoconch smooth, distinct. Interior smooth, muscle scars indistinguishable. No lateral teeth; a small cardinal tubercle under the

umbo. Length, 3.5 mm.; height, 2.45 mm.; depth of single valve, 1.5 mm.

Only two left valves were obtained of this species, which belongs to the same section of the genus as *C. brazieri*, Smith, from which, as from other co-generic forms, the abrupt anterior end distinguishes it.

*BORNIA RADIATA*, *sp. nov.*

(Fig. 12).

Shell thin, diaphanous, rather compressed, oblong, inequilateral, the posterior side being twice the length of the anterior: a slight median sinus. Umbo prominent, prodissoconch conspicuous.

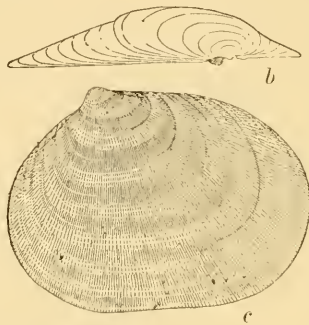
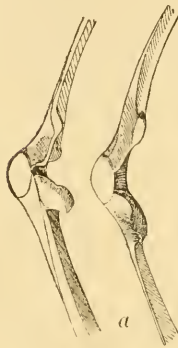

Fig 12.

*Bornia radiata*.

Surface dull. Colour pale yellow, irregularly zoned with opaque white. Sculpture, of fine, dense, radiating hair lines, which grow coarser on approaching the valve margin, with reticulate fine and coarse concentric growth lines. Here and there concentric sulci, indicating growth interruptions, break the continuity of the surface. Within smooth and glossy; muscle scars hardly visible; external sculpture appearing through the valve. Height, 4.6 mm.; length, 6 mm.; depth of single valve, 1.25 mm.

Numerous odd valves were secured.

GASTEROPODA.

*ASTELE BILIX*, *sp. nov.*

(Fig. 13).

Shell small, depressed-conical, a little broader than high; spire gradate. Nucleus lost, six whorls remain. Colour, base white; upper surface lemon yellow, articulated on the periphery with

white and chocolate. Sculpture, of fifty sharp beads arranged as a projecting keel around the periphery. Above the suture and periphery runs a spiral cord which doubles on the last whorl. From suture to periphery, overriding the spirals in their course, radiate sharp, narrow, elevate lamellæ. They conspicuously lattice a furrow beneath the peripheral bead row, and there end abruptly.

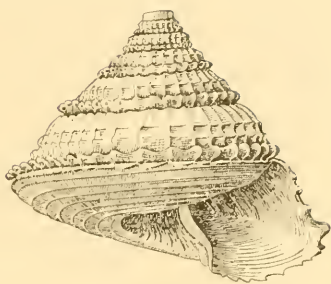

Fig. 13.  
*Astele bilix.*

The radiate lamellæ continue from whorl to whorl, here and there fresh rows are intercalated. Base flattened, ornamented by eight narrow-spaced spiral riblets, broken into fine close-packed granules. Umbilicus a quarter of the diameter of the base, deep and steep, margined by a row of small tubercles. Aperture simple, rhomboidal. Columella margin a little reflected, inserted on the umbilical bead-row. Height, 2.6 mm.; maj. diam., 3.2 mm.; min. diam., 2.75 mm.

A single specimen, apparently not adult, was collected. Like several other *Astele* it resembles *Basilissa*, to which, when perfect examples arrive, it may have to be transferred. The peculiar sculpture will, at any rate, serve to distinguish the species in any stage of growth.

*LIOTIA ALAZON, sp. nov.*

(Fig. 14).

Shell minute, solid, turbanate, elevate, tricarinate, descending at the aperture, narrowly umbilicate. Surface smooth and glossy. Colour, porcelain white. Whorls three, the first a protoconch. Sculpture, of three projecting lamellate keels revolving from the protoconch to the aperture. The third keel of the penultimate whorl is half covered by the suture of the following whorl. From the first keel, which runs along the shoulder, a nearly flat shelf extends to the suture. From the first to the third keel the side of the shell is nearly perpendicular.

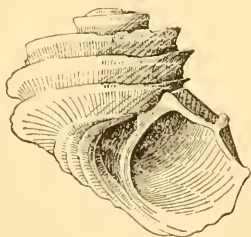

Fig. 14.  
*Liotia alazon.*

Around the umbilicus are three spiral cords. Aperture oblique, angled above, rounded below, outer lip neither thickened nor reflected, Umbilicus deep, narrow, contracted by the columella. Major diam., 1.75 mm.; minor diam., 1.37 mm.; height, 1.5 mm.

A single specimen occurred.

*ADEORBIS ANGULATA*, *sp. nov.*

(Fig. 15).

Shell of moderate size, surface dull. The summit a flat expanse, from which the protoconch and first whorl project, and which is bounded by an angle or spiral rib, whence the side descends perpendicularly. A similar keel occurs where the side meets the base, and a third margins the wide concave umbilicus. Colour, pale yellow. Whorls four and a half, rapidly increasing. Sculpture, somewhat like that of *Vanikoro*. The first adult whorl has strong spaced radial lamellate ribs which gradually fade away with the increase of the the shell, but which persist longest as scales upon the keels. Fine, irregular growth lines occur on the

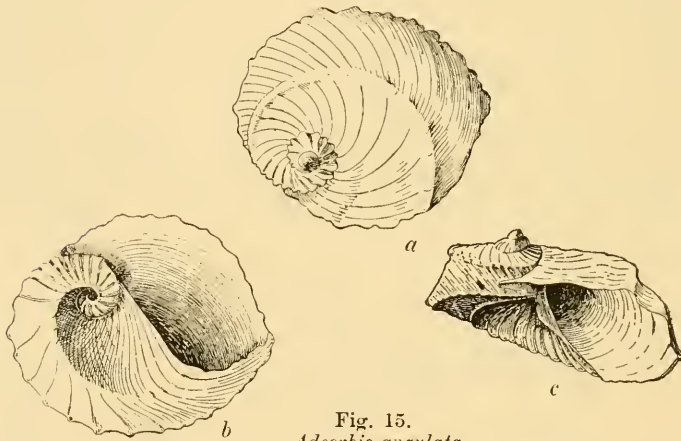

Fig. 15.  
*Adeorbis angulata*.

last whorl. Spiral sculpture absent. Aperture oblique, rhomboidal, lip thin. The type is 3.65 maj. diam.; 2.5 min. diam. 2.0 mm. height, but a fragment of a larger individual indicates that the species forms another whorl, and attains a height of 6 mm.

There are but three species of the genus reported from Australia, *A. angasi*, from New South Wales, *A. vincentina*, Angas, from South Australia, and *A. plana*, A. Ad. (*A. sigaretinus*, Pilsbry) from Queensland.

The keeled whorls readily distinguish the novelty from *A. angasi*, which it approaches nearest.

*CERITHIOPSIS HALLIGANI*, *sp. nov.*

(Fig. 16).

Shell small, slender, elongate-conical, pale yellow, the upper rib on each whorl white. Whorls twelve, including a three-whorled protoconch. Sculpture, on the first adult whorl, two, on the following three, and on the last four, sharp projecting spiral keels. The third or anterior keel of the spire whorls is larger than the others, and is separated from them by a broader space than intervenes between the first and second. The fourth keel of the body whorl reappears on a few of the preceding whorls as a small supersutural thread. Fine radial striae cross the grooves between the keels. The protoconch is smooth, with whorls bulging in the middle like that of *C. turbonilloides*. Aperture quadrate, canal short. Base rounded. Length, 5.6 mm.; breadth, 1.4 mm.

A single specimen.

The species is related to *C. purpurea*, Angas, but differs by being half the size, more conical in outline, with closer ribs, round base, and different colour.



Fig. 16.  
*Cerithiopsis halligani*.

*PSEUDORISSOINA ELEGANS*, *sp. nov.*

(Fig. 17).

Shell minute, glassy translucent, tapering. Whorls six, and an involute tilted protoconch. Below the suture appears an opaque flattened zone, defined by a revolving groove. The zone grows narrower with the increase of the whorls. Aperture effuse, pyriform oblique, peristome slightly thickened and incurved, outer lip retreating to the suture. A callus is spread on the preceding whorl. Behind the columella is a minute umbilical crevice. Length, 3.15 mm.; breadth, 1.15 mm.

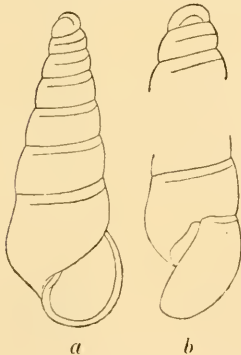

Fig. 17.

*Pseudorissoina elegans*.

Several specimens were taken. This species is a northern representative of *P. tasmanica* than which *P. elegans* is a third smaller, but has an extra whorl, tapers more rapidly, and has the subsutural stricture more defined.

*SCALA TURRISPARI, sp. nov.*

(Fig. 18).

Shell minute, solid, very tall and slender, conspicuously tabulate. Colour, pale cream. Whorls eight and a half (including two and a half whorled protoconch), deeply constricted at the suture, flattened medially, and angled above and below. Sculpture, the protoconch smooth and glossy, extreme apex asymmetrically protuberant, remainder with two spiral keels, and a third margining the suture. After the protoconch the adult sculpture commences suddenly without transition. The adult whorls are obliquely crossed by about seventeen blunt, close set, widely and squarely projecting lamellæ, which disappear on the base. Both lamellæ and interstices are crossed by fine, dense, spiral grooves which fret the lamellæ blades. Aperture round. Length, 2.64 mm.; breadth, 0.8 mm.



Fig. 18.  
*Scala turrisphari.*

The four specimens before me are not sufficiently perfect to furnish full details of length, number of whorls, aperture, and base. The turrited spire, peculiar ribbing, and small size of the novelty, amply distinguish it from any Australian species.

*SCALA MINUTULA, Tate and May.*

(Fig. 19).

*Scalaria (Acrilla) minutula*, Tate and May,  
Trans. Roy. Soc. S. Austr., xxiv., 1900, p.  
95.

This species has not hitherto been traced so far north. It appears to me to be related rather to the Rissoidæ than to the Scalidæ.



Fig. 19.  
*Scala minutula.*



*MANGELIA EMINA, sp. nov.*

(Fig. 20).

Shell fusiform, variable in contour, colour, and development of sculpture. Whorls, five and a half, including a two-whorled protoconch, rapidly increasing, slightly shouldered. Protoconch smooth, glassy, globose. Colour variable; sometimes entirely drab or buff, often with the protoconch and the subsutural space darker. The example figured has a ground colour of pale cinnamon, banded or spotted with pale cream, below the suture a band of chocolate, deep within the inner lip a tinge of purple, protoconch a clear hazel-brown. Sculpture, longitudinal wave ribs sharply bent near the suture, fading away on the base, and leaving a bare space behind the aperture, wider spaced above, more crowded and irregular below; on the last whorl are fourteen, on the penultimate eighteen. Both ribs and interspaces are crossed by sharp, minute, close, waved, spiral grooves. The flat-topped interspaces of these grooves, four times their width, are again cross-cut by close minute furrows into oblong beads. Aperture narrow, three-fifths of the shell's length, fortified without by a broad but low incurving varix, which rises above the suture, enclosing a shallow sinus; a layer of callus overspreads the inner lip. Canal short and broad. Length, 11 mm.; breadth, 4.5 mm.

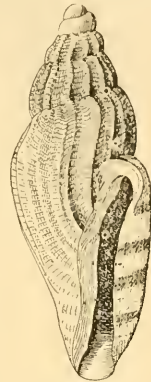

Fig. 20.  
*Mangelia emina.*

One specimen.

I have long been acquainted with this species, though an example perfect enough for description has hitherto evaded me. The "Thetis" took it in 63-75 fathoms off Port Kembla; in 50-52 fathoms off Botany Bay; and in 22-38 fathoms off Port Hacking. It occurred to me in 100 fathoms off Wollongong.

In its immature state it has a general resemblance to *Cythara kingensis*, Petterd, from which the varix of the adult immediately severs it.

*BATHYTOMA SARCIKULA, sp. nov.*

(Fig. 21).

Shell small, solid, ovate-fusiform. Colour, pale yellow, with a rusty tinge at the suture. Whorls, three and a half, including a protoconch of one flat whorl. Sculpture, on the protoconch

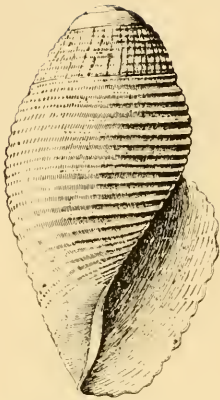

Fig. 21.  
*Barthyotoma sarcinula*.

fine spiral grooves, continued on the adult as broad, shallow furrows, which are broadest at the suture becoming smaller and closer anteriorly. On the last whorl are twenty-two spiral ribs, on the penultimate six; the latter are latticed by fine radial riblets. The whole shell is crossed by fine, arcuate growth lines. Aperture narrow, sinus deep, lip thin, straight, produced medially, edge crenulated by the sculpture. No callus on the inner lip. Columella broad and twisted; canal not produced. Length, 7 mm.; breadth, 4 mm.

One specimen represents this species, which is broader than *B. biconica*,<sup>7</sup> at a corresponding length.

*CYLICHINA TENUIS*, *sp. nov.*

(Fig. 22).

♂ Shell small, elongate, subcylindrical, a little contracted at each extremity; truncate at the summit, smooth translucent, sometimes with an opaque belt or row of patches around the upper quarter of the body whorl. Sculpture, a small spiral thread keel runs around the vertex, fine growth lines radiate the summit, but are scarcely perceptible on the sides of the shell. Apical perforation narrow, deep, a seventh of the shell's diameter, partly showing the penultimate whorl. Aperture long, perpendicular, narrow, a slight callus layer spread on the inner lip. Columella a little thickened, spirally twisted.

Length, 2.45 mm.; breadth 1.05 mm.

Two examples.



Fig. 22.  
*Cylichina tenuis*.

<sup>7</sup> Hedley—Austr. Mus. Mem., iv., 1903, p 385 f. 98.

NOTES ON FISHES FROM WESTERN AUSTRALIA.—No. 3.<sup>1</sup>

BY EDGAR R. WAITE, F.L.S., Zoologist.

(Plates viii.—xvii., and fig. 23.)

A third collection of Fishes from Western Australia has been forwarded to the Trustees, by Mr. Bernard H. Woodward, Curator of the Western Australian Museum.

This collection is larger, and richer in novelties than the preceding ones, and yields three new genera :—

*Neatypus* of the family Scorpididæ

*Bramichthys* of the Bramidæ

*Dipulus* of the Brotulidæ.

Nine species are described as new :—

*Catulus labiosus*.

*Synodus sageneus*.

*Neatypus obliquus*.

*Chetodon assarius*.

*Bramichthys woodwardi*.

*Cynoglossus broadhursti*.

*Dipulus cæcus*.

*Pseudomonacanthus galii*.

*Chetodernis maccullochi*.

Figures of these are supplied, and also of the following known species, not previously illustrated :—

*Terapon humeralis*, Ogilby.

*Hypsipops microlepis*, Günther.

*Pseudolabrus punctulatus*, Günther.

*Patæcus maculatus*, Günther.

Many of the fishes received are duplicates of those previously determined, and are not included in the present paper. A number of species, however, known from Western Australia is herein enumerated; these claim inclusion by virtue of the precise localities recorded. The majority of such are new to the west coast, they having previously been known from King George's Sound only, which, though politically in the Western State, is on the south coast of the Continent.

---

<sup>1</sup> No. 1. Rec. Austr. Mus., iii., 1900, pp. 210-216, pl. xxxvii.; No. 2. *Ibid.*, iv., 1902, pp. 179-194, pls. xxvii-xxxi.

The types of the new species have been returned to the Western Australian Museum.

The collection, as originally received, was supplemented by a number of fishes recently taken by means of the trawl.

I am indebted to Mr. C. F. Gale for a copy of the Annual Report on the Fishing Industry of Western Australia.<sup>2</sup> The Report for 1904 contains an account of the first trawling operations undertaken in the State. From this we learn that the ketch "Rip," a vessel of ninety tons, was chartered for the purpose and that the trawl was shot no less than one hundred and one times, the greatest depth reached being 40 fathoms. Five charts accompany the report, showing various stations from Cape Naturaliste, northward to Shark's Bay. Trawling was also tried off Rottnest Island and Houtman's Abrolhos.

It is to be deplored that no professional zoologist was aboard the "Rip," and it cannot be doubted that, in consequence, much valuable material and information has been lost. A tally was certainly taken in fishermen's style, but the mere enumeration of "soles, gurnard, flathead, rays, cod, leather-jackets, etc.," conveys no precise information. Records of edible fishes only appear to have been preserved, no detailed account having been taken of the smaller forms which furnish food for the edible ones or which may be, in other ways, concerned in their economy. With the exception of crustaceans and sponges no account whatever was taken of the Invertebrate life, such being entered as "marine growth," and, judging by the experience gained in H.M.C.S. "Thetis" in the waters of New South Wales, an immense wealth of such forms must have been netted.

The collection is said to contain representatives of all the fishes obtained; it requires, however, a trained eye to discriminate in this matter, and it must be evident, as above hinted, that many species taken were lost sight of; in fact some fishes are enumerated in the report, examples of which were not forwarded. Of these I may instance skate, electric, sting and other rays, trumpeter, john dorey, horse mackerel, flathead, whiting and skipjack. Many of the takes are entered as "small fish of all kinds" or "a lot of fish of other classes," and in no case is it possible to associate a specimen with the particular station whence it was obtained; the mere mention of say, red mullet, cod, parrot fish or gurnard gives no clue to the species taken.

At the 41st haul a sea snake, four feet long, was netted, and on August 7th and 10th whales were freely encountered.

---

<sup>2</sup> Western Australia—Rept, Fishing Industry and Trawling Operations, 1904 (1905).

A small sailing vessel is not suited for trawling investigations and the promoters were evidently much handicapped by want of a proper boat. When further operations are undertaken it is to be hoped that the whole project will be placed in competent scientific hands. The services of a professional Zoologist, in an undertaking of this kind, should be recognised as a necessity in Australia equally with Europe and America.

Mr. Woodward asks me to state that the Trustees of the Western Australian Museum are greatly indebted to Mr. C. F. Gale, the Chief Inspector of Fisheries for Western Australia, and to Mr. F. C. Broadhurst, for the fishes obtained by means of the trawl.

*CATULUS LABIOSUS, sp. nov.*

(Fig. 23).

Length of head 7.75 in the total length; width of head 1.06; length of snout 3.2; interorbital width 2.66; width of mouth 1.54; diameter of eye 4.4; and length of pectoral fin 1.1 in that of the head.

Nasal valves separate, each produced into a lobe directed outwards and backwards; the distance between the two slightly more than the basal width of one lobe. No cirrus. A long

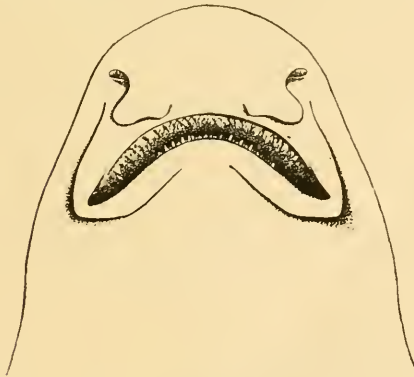

Fig. 23.  
*Catulus labiosus.*

labial fold round the angles of the mouth, the fold of the upper jaw produced anteriorly beyond the lobe of the nasal valve and to within a short distance of the nostril; the folds of the lower jaw approach each other to within the length of the base of one of the nasal lobes. These features are illustrated in the accompanying figure, which is two-thirds natural size.

Teeth in several rows in both jaws, those of the lower jaw, the larger; all have a small cusp on each side. Head much depressed, its width considerably more than its length in advance of the spiracles. Body elongate, the vent in advance of the middle of the total length. First dorsal fin inserted above the hinder edge of the vent.

*Colours*.—Brown above, lighter beneath. Hinder part of head, the body and the under surface, from between the pectorals backwards, ornamented with fairly uniform black spots. The dorsals, anal and caudal similarly marked: three series of spots on the ventrals tend to form transverse bars. One example—a male—620 mm. in length.

*Loc.* Fremantle.

ELOPS SAURUS, *Linnaeus*.

*Elops saurus*, Linnaeus, Syst. Nat., ed. xii., 1766, p. 518.

*Loc.*—Murray River, near Mandurah.

CLUPANODON NEOPILCHARDUS, *Steindachner*.

*Clupea neopilchardus*, Steindachner, Denk. K. Akad. Wiss. Wien, xli., 1879, p. 12.

*Loc.*—Houtman's Abrolhos.

GYMNOTHORAX PUNCTATOFASCIATUS, *Bleeker*.

*Gymnothorax punctatofasciatus*, Bleeker, Ned. Tijdschr. Dierk. i., 1863, p. 167.

*Loc.*—Three examples referred to this East Indian species were trawled between Fremantle and Houtman's Abrolhos.

TRACHINOCEPHALUS MYOPS, *Forster*.

*Salmo myops*, Forster, in Bloch and Schneider, Syst. Ichth., 1801, p. 421.

*Loc.*—Trawled between Houtman's Abrolhos and the mainland of Western Australia.

SAURIDA TUMBIL, *Bloch*.

*Salmo tumbil*, Bloch, Ichty., xii., 1795, p. 100, pl. cccexxx.

*Loc.*—Trawled off Fremantle.

SYNODUS SAGENEUS, *sp. nov.*

(Plate viii., fig. 1.)

D. 12; A. 15 V. 8; P. 13; L. l. 52; L. tr. 4/7

Length of head 3.66; height of body 7.0 in the total length. Diameter of eye 7.8; and length of snout 4.8 in that of the head. Interocular space equal to the orbital diameter. The head is subquadrangular in section, a long shallow groove above, extends from the tip of the snout to the occipital region. Snout

greatly depressed, acute and broader than long. The orbit cuts the upper profile, the upper half being directed superiorly, the outer half sublaterally. The jaws are equal, and the premaxillary is 1.56 in the length of the head.

The body is very stout, broader than high; the caudal peduncle quadrangular. Origin of dorsal nearer the adipose fin<sup>3</sup> than the snout by an eye's diameter. The anterior rays, when depressed, reach just beyond the insertion of the last ray, which is not filamentous, the second ray is a little shorter than the length of the fin or 1.8 in that of the head. The anal increases in length backward, its last ray being twice the diameter of the eye. The inner ventral rays are very long, the sixth being 1.25 in the length of the head, and reaching beyond the posterior insertion of the dorsal; the pectoral is short and rounded, and the caudal deeply forked.

*Scales.*—The tip of the snout and the median groove as far as the eyes are smooth. The top of the head including the upper, hinder and lower margin of the eye is rugose, as is also the upper edge of the humerals. Seven rows of scales on the cheek, and about three on the upper part of the opercle. No keel on the lateral line.

*Colours.*—Yellow above and silvery beneath. All the scales broadly margined with reddish brown, the effect being very marked on the lower surface. Owing to the roundness of the body, the number of scales in the transverse series, cannot be shown in the illustration. One example, 265 mm. in length.

*Loc.*—Trawled between Fremantle and Houtman's Abrolhos.

#### AULOPUS PURPURISSATUS, *Richardson.*

*Aulopus purpurissatus*, Richardson, *Icon. Pisc.*, 1843, p. vi., pl. ii., fig. 3.

*Loc.*—Mandurah.

#### CENTRISCUS SCUTATUS, *Linnaeus.*

*Centriscus scutatus*, Linnaeus, *Syst. Nat.*, ed. i., 1758, p. 336.

Saville Kent mentions this species as occurring on the Barrier Reef, but in respect to colouration his figure seems rather to represent *Holiscus strigatus*, Günther, recorded from Cape York; it must however be noted that the spine of the cuirass is represented as unjointed, and that three dorsal spines are

<sup>3</sup> The adipose fin is absent, but a pit suggests its position

shown in the membrane below, these are characters of *C. scutatus*. *Amphisile cristata*, De Vis,<sup>4</sup> appears to be a synonym of *C. scutatus*, the presence of "three radiating dorsal spines" suggesting that the spine of the cuirass was unjointed; the example described was taken at Noosa on the Queensland coast between Brisbane and Wide Bay, it measured eleven inches (280 mm.) in length.

*Loc.*—Two fine examples of equal size (222 mm.), forwarded by Mr. Woodward, were trawled in the waters to the north of Houtman's Abrolhos.

MYXUS ELONGATUS, *Günther*.

*Myxus elongatus*, Günther, Cat. Fish. Brit. Mus., iii., 1861, p. 466.

*Loc.*—Mandurah.

SPHYRENA OBTUSATA, *Cuvier & Valenciennes*.

*Sphyræna obtusata*, Cuvier and Valenciennes, Hist. Nat. Poiss., iii., 1829, p. 350.

The Abrolhos Islands have furnished us with two examples of this species: it thus ranges along both east and west coasts of the Continent. It is not recorded by Lucas (1890) from Victoria nor by Johnston (1890) from Tasmania.

Castelnau records *S. novæ-hollandiæ*, Günther, from Western Australia. This species is common along the southern and south-eastern seaboard, and is also known from Tasmania.

BERYX AFFINIS, *Günther*.

*Beryx affinis*, Günther, Cat. Fish. Brit. Mus., i., 1859, p. 13.

Though not previously recorded from the west coast, its known distribution would suggest its inclusion as a member of the fauna.

*Loc.*—Houtman's Abrolhos.

HOLOCENTRUM RUBRUM, *Forskål*.

*Sciæna rubra*, Forskal, Descr. Anim., 1775, p. 48.

*Loc.*—Mandurah.

MONOCENTRIS GLORIA-MARIS, *De Vis*.

*Cleidopus gloria-maris*, De Vis, Proc. Linn. Soc. N. S. Wales, vii., 1882, p. 368.

---

<sup>4</sup> De Vis—Proc. Linn. Soc. N. S. Wales, ix., 1885, p. 872.



An example taken by the trawl between Houtman's Abrolhos and the mainland is an addition to the fauna of Western Australia. The species was previously known only from Eastern Australia, southward to Port Jackson.

It is evident from Dr. Boulenger's<sup>5</sup> account of the distribution of the genus that the Mauritius species is referable to *M. japonicus* and not to *M. gloria-maris* as might be suspected.

ACANTHISTIUS SERRATUS, *Cuvier & Valenciennes.*

*Plectropoma serratum*, Cuvier and Valenciennes, Hist. Nat. Poiss., ii., 1828, p. 399.

Hitherto the coast of New South Wales has been regarded as the restricted habitat of this species, though specimens recorded from "Australia" may have been obtained from other coasts.

The collection includes three specimens, two of which are normal and indistinguishable from examples taken in Port Jackson; the third has, in addition to the usual spots, four dark vertical bands, wider than the interspaces; the first embraces the occiput and the first two dorsal spines, the second the sixth to eleventh spines, the third is at the base of the anterior rays and the fourth includes the hinder rays and portion of the caudal peduncle, the two last, only, reach the ventral profile. There are also markings on the head similar to those of *A. cinctus*. Examples from New South Wales have been, though rarely, seen in which similar markings are traceable, though in a much less degree than in the example above described.

*Loc.*—Houtman's Abrolhos.

CENTROGENYS VAIGENSIS, *Quoy & Gaimard.*

*Scorpaena vaigensis*, Quoy and Gaimard, Voy. "Uranic et Physicenne," 1824, p. 324, pl. lviii., fig. 1.

*Loc.*—North West Australia.

EPINEPHELUS FASCIATUS, *Forsk.*

*Perca fasciata*, Forskal, Descr. Anim., 1775, p. 40.

*Loc.*—Houtman's Abrolhos.

COLPOGNATHUS DENTEX, *Cuvier & Valenciennes,*

*Plectropoma dentex*, Cuvier and Valenciennes, Hist. Nat. Poiss., ii., 1828, p. 394.

*Loc.*—Houtman's Abrolhos.

---

<sup>5</sup> Boulenger.—Cambridge Nat. Hist., vii., Fishes, 1904, p. 656.

LATES CALCARIFER, *Bloch.*

*Holocentrus calcarifer*, Bloch, Ichty., vii., 1790, p. 100, pl. cexliv.

*Loc.*—Houtman's Abrolhos.

LUTIANUS CHRYSOTENIA, *Bleeker.*

*Mesoprion chrysotenia*, Bleeker, Nat. Tijds. Ned. Ind., ii., 1851, p. 170.

*Loc.*—Houtman's Abrolhos.

TERAPON HUMERALIS, *Ogilby.*

*Therapon humeralis*, Ogilby, Proc. Linn. Soc. N. S. Wales, xxiv., 1899, p. 177.

(Plate ix.)

Of three examples forwarded, one exceeds the dimensions of the type, measuring 210 mm. The accompanying illustration depicts our smallest specimen of natural size, and, as will be seen, it differs somewhat from the type in the extent of its colour markings. In this the body bands extend below the lateral line, and the upper portion of the body and caudal peduncle are spotted, in addition to the vertical fins.

*Loc.*—The range of the species cannot yet be extended, all known examples being from Houtman's Abrolhos.

PENTACEROPSIS RECURVIROSTRIS, *Richardson.*

*Histiopterus recurvirostris*, Richardson, Voy. "Ereb. and Terr.", 1845, p. 34, pl. xxii., fig. 5-6.

*Loc.*—Fremantle. Also trawled; the "Striped Boarfish" mentioned in the Fisheries Report, probably referring to this species.

PSEUDOCROMIS MUELLERI, *Klunzinger.*

*Pseudochromis muelleri*, Klunzinger, Sitzb. Akad. Wiss. Wein., lxxx., 1879, p. 370.

*Cichlops filamentosus*, Macleay, Proc. Linn. Soc. N. S. Wales, v., 1881, p. 570.

The examples described by Klunzinger and Macleay were both obtained from Port Darwin. Those forwarded from the Western Australian Museum were taken on the North-Western Coast of the Continent, and are therefore additions to the fauna of the Western State.

CICHILOPS LINEATUS, *Castelnau*.

*Dampiera lineata*, Castelnau, *Researches Fish. Austr.*, 1875, p. 30.

*Loc.*—Houtman's Abrolhos.

SCIENA ANTARCTICA, *Castelnau*.

*Sciœna antarctica*, Castelnau, *Proc. Zool. Soc. Vict.* i., 1872, p. 100.

*Loc.*—Mandurah.

CHILODACTYLUS NIGRICANS, *Richardson*.

*Chilodactylus nigricans*, Richardson, *Proc. Zool. Soc.*, 1850, p. 63.

*Loc.*—Houtman's Abrolhos.

CHIRONEMUS MACULOSUS, *Richardson*.

*Threpterus maculosus*, Richardson, *Proc. Zool. Soc.*, 1850, p. 70, pl. ii., figs. 1-2.

The collection includes one example of this species. It agrees exactly with Richardson's description and figure, which are sufficiently exhaustive. Though the number of dorsal spines is correctly copied as fourteen, by Günther<sup>6</sup>, they are for generic purposes rendered as fifteen in the synopsis (p. 70), this number applies only to *C. georgianus* and *C. marmoratus*.

*Loc.*—The specimen examined is from Houtman's Abrolhos and measures 270 mm. in length.

POMADASIS HASTA, *Bloch*.

*Lutjanus hasta*, Bloch, *Ichty.*, vii., 1790, p. 87, pl. cxxlvi., fig. 1.

*Loc.*—Fremantle.

SCOLOPSIS BIMACULATUS, *Rüppell*.

*Scolopsis bimaculatus*, Rüppell, *Atlas Fische*, 1828, p. 8, pl. ii., fig. 2.

*Loc.*—Houtman's Abrolhos.

TEPHREOPS TEPHREOPS, *Richardson*.

*Crenidens tephreops*, Richardson, *Voy. "Ereb. and Terr."*, 1846, p. 69, pl. xli., fig. 1.

*Loc.*—Houtman's Abrolhos.

---

<sup>6</sup> Günther—*Cat. Fish. Brit. Mus.*, ii., 1860, p. 78.

UPENEUS POROSUS, *Cuvier & Valenciennes*.

*Upeneus porosus*, Cuvier and Valenciennes, Hist. Nat. Poiss., iii., 1829, p. 455.

Specimens taken at Fremantle are possibly co-specific with the example recorded by Castelnau as *U. vlamingii*.

SCORPIS GEORGIANUS, *Cuvier & Valenciennes*.

*Scorpis georgianus*, Cuvier and Valenciennes, Hist. Nat. Poiss., viii., 1831, p. 503, pl. ccxlv.

*Loc.*—Mandurah.

NEATYPUS, *gen. nov.**Family* SCORPIDIDÆ.

Head and body compressed, completely scaled. Scales moderate, finely ciliated and irregularly arranged; lateral line complete. Mouth small, transverse, slightly protractile. Maxillary small; a broad band of trilobed movable teeth in each jaw: vomer and palatines toothless. Gill membranes united, free from the isthmus. Seven branchiostegals. Gill-rakers long. A single dorsal with ten spines and about twenty-two rays, the spinous portion well developed but shorter than the soft; anal with three spines, the second long and strong, and about eighteen rays. The bases of the spinous portion and the whole of the soft portion of both fins, densely covered with small scales. Caudal scaled like the vertical fins. Pectoral with fifteen rays, the upper of which are longest, the tip rounded. Ventrals inserted close together, behind the base of the pectorals, spine strong.

The genus is allied to *Atypichthys*, Günther<sup>7</sup>, differing by the character of the teeth and the scaly base of the spinous portion of the vertical fins. The greater vertical development of these fins at once distinguishes it from *Scorpis*, and possibly also from *Parascorpis*. The small mouth prevents any confusion with *Atyposoma*, and the general habit with other two genera included by Dr. Boulenger<sup>8</sup>, *Psettus* and *Henoplosus* (*Enoplosus*).

It has much the habit of *Chatodon*, but differs therefrom by the nature of the teeth and by the gill membranes being free from the isthmus. Of this last character Boulenger writes under *Chatodontidae*<sup>9</sup>:—"Closely allied to and evidently derived from

<sup>7</sup> Günther.—Cat. Fish. Brit. Mus., ii., 1860, p. 64, and iv., 1862, p. 510.

<sup>8</sup> Boulenger—Cambridge Nat. Hist., vii., Fishes, 1904, p. 666.

<sup>9</sup> Boulenger.—*Loc. cit.*, p. 667.

the more generalised types of the *Scorpididae*, differing in the attachment of the gill-membranes to the isthmus." Though valid for the family, as a whole, this character does not hold good for *C. (Microcanthus) strigatus* in which the membranes are united and free from the isthmus.

NEATYPUS OBLIQUUS, *sp. nov.*

(Plate x.)

D. x. 22; A. iii. 18; V. i. 5; P. 15; C. 17; L. lat. 51.

Length of head 3·8; height of body 2·1 in the total; diameter of eye 2·5; length of snout 3·9 and of caudal 2·0 in the length of the head; interorbital space convex, slightly less than the diameter of the eye; hinder limb and angle of preopercle denticulated, lower limb smooth.

Body compressed, ventral profile but little lower than that of the dorsal.

*Fins.*—The dorsal fin originates above the margin of the opercle, the spines regularly increase in height to the sixth, which is 1·7 in the length of the head, the following spines are but slightly lower, the anterior rays are of the same height as the last spines, and gradually decrease in length, the contour of the fin is thus unbroken. The anal commences beneath the beginning of the soft dorsal. Its second spine is very strong and long, much longer than the sixth dorsal and 1·3 in the length of the head; the third spine is weaker and a little shorter; the anterior rays are longer than the corresponding ones of the dorsal, and the margin of the fin is almost straight. The ventral spine is equal to the fourth dorsal, and the longest rays are of the same length as the pectoral, 1·4 in that of the head. The caudal is emarginate and the depth of its peduncle is equal to the diameter of the eye.

*Colours.*—The ground colour is pale grey, with six oblique dark brown bands, each of which is bordered with black. The first is double above, the anterior portion arising between the eyes, with a strong concavity to the front, the posterior portion passes from above the hinder margin of the eye, and merged with the anterior limb, passes downwards across the preopercle to the ventral spine. The second band originates on the occiput, crosses the edge of the opercle and base of the pectoral fin, and attains the lower profile at the middle of the adpressed ventral spine. Each band becomes successively more oblique, the third passing from the base of the three first dorsal spines to the commencement of the anal. The next band joins the v.-vii. dorsal spines

and the middle of the anal fin. The fifth band originates at the posterior dorsal spines and proceeds to the posterior anal rays, the last band runs nearly parallel to the margin of the dorsal rays and on to the caudal peduncle, the four posterior bands extend on to the scaly portion of the dorsal and anal fins.

*Loc.*—Two specimens, taken at Houtman's Abrolhos, the larger measuring 152 mm. in length.

*EPHIPPIUS MULTIFASCIATUS, Richardson.*

*Scatophagus multifasciatus*, Richardson, Voy. "Ereb. and Terr.", 1846, p. 57, pl. xxxv., figs. 4-6.

*Loc.*—Fremantle. The "Butter Fish" mentioned as having been trawled may refer to this species.

*CHÆTODON ASSARIUS, sp. nov.*

(Plate xi., fig. 1).

D. xiii. 21 ; A. iii. 17 ; V. i. 5 ; P. 16 ; C. 17 + 6.

Length of head 3·7 ; of caudal fin 5·2 ; height of body 1·5 in the total length. Diameter of eye 3·0, and length of snout 3·5 in that of the head. Interocular space convex, equal to the diameter of the eye. Preoperculum smooth, body ovate, strongly compressed ; the upper profile rounded, the lower convex. The fifth dorsal spine is the highest, its length twice the diameter of the eye ; from this point the fin falls gradually away to an obtuse angle at about the middle of the rayed portion. The second anal spine is longest, its length being one-half that of the head ; this fin is evenly rounded ; the ventral spine is 1·6 in the length of the head, and the longest pectoral ray 1·3 in the same.

The scales are in regular series, not in contrary directions, those of the middle of the sides larger than the others ; the lateral line forms an even arch, lower than the dorsal profile and terminates in advance of the posterior insertion of the dorsal fin.

*Colours.*—Ground colour yellow or pale brown, snout darker, the dark ocular band is complete above and is a little narrower than the eye, above the orbit it is bordered before and behind with a light band, below it extends to the margin of the subopercle. The body bears, on its upper half, four very narrow dark vertical bars slightly inclined forward below, they pass downwards from the bases of the fourth, sixth, eighth and tenth dorsal spines respectively. The dorsal fin is narrowly edged with black : following the angle, the colour becomes submarginal, the extremity of the rays being white. A black white-edged

ocellus is present in the angle. The margin of the anal is a rather broad white band within which is a dark brown one, very narrow at the spines but increasing in depth so that it occupies nearly the whole of the posterior rays. Pectoral and ventral without markings. A very faint broad bar across the caudal peduncle, in line with the anal band.

Length of specimen 119 mm. trawled in the waters between Fremantle and Houtman's Abrolhos.

This species has affinities with *C. mertensii*, Cuvier and Valenciennes and the very closely allied *C. dixoni*, Regan: differential characters are the angulate soft dorsal with its contained ocellus, the sub-vertical and scarcely oblique body bars which have a different inclination from those of the other species mentioned, also the absence of the yellow area on the posterior part of the body. Bleeker placed his *C. xanthurus* as synonymous with *C. mertensii*, but Mr. C. T. Regan appears to regard this as distinct also.<sup>10</sup>

#### CHELMONOPS TRUNCATUS, *Kner.*

*Chaetodon truncatus*, Kner., Sitzb. Acad. Wiss. Wien, xxxiv., 1859, p. 442, pl. ii.

*Loc.*—The specimen trawled between Houtman's Abrolhos and Fremantle is the largest I have seen, measuring 222 mm. in length.

#### HYPSIPOPS MICROLEPIS, *Günther.*

(Plate xii.)

D. xii.-xiii. 15-18; A. ii. 13-16; V. i. 5; P. 21; C. 17.

The great variation which this species undergoes during the course of its growth is responsible for several erroneous determinations and additions to the synonymy.

The changes which take place during the life of the species to maturity, have been lately studied by Mr. Allan R. McCulloch, and the following notes are based upon his observations.

In the smallest specimens examined (15 mm.), the characteristic markings are developing, but are not clearly defined; the scales also are incomplete, the head and back as far as the dorsal fin being naked. The scales do not yet appear on the fins, and the caudal is emarginate. All the rays are simple.

<sup>10</sup> Regan.—Ann. Mag. Nat. Hist., (7), xiii., 1904, p. 277.

Specimens 22 mm. in length present a most gorgeous appearance, being of brilliant orange colour, tempered on the upper part of the body by numerous black dots, which are much larger in the space between the dorsal and anal fins. Three broad dark-edged blue lines run from the head backwards; the first arises on the snout, behind the upper lip, where it is connected with its fellow on the other side, and skirts the profile to the anterior dorsal spines; the second, indicated in front of the eye, passes across the upper part of the eyeball and above the lateral line to a large black blue-edged ocellus, which occupies the last six spines and portion of the back beneath; the third runs from the corner of the mouth, below the eye, across the opercle, and is continued as a dot above the basal portion of the pectoral fin. There may also be two or three similar dots between the pectoral and the caudal. A large dark spot is also present on the upper part of the caudal peduncle. The spinous dorsal fin is reddish, with a blue margin, the bases of the soft dorsal and anal are orange, the remaining portion and of the pectoral and caudal hyaline. Ventral fin orange, the first, elongate, ray and the anterior edge of the anal black. This stage is illustrated in fig. 1.

Somewhat larger examples were identified by Bennett with *Glyphisodon biocellatus* and by the writer with *G. brounriggii*.

In a much later stage, represented by examples measuring 72 mm. in length, the dorsal stripes are relatively much narrower and are broken, the lowermost being indicated by dots only, the ocellus is more restricted in area, being confined to the last two spines. A white patch is present on the opercle and numerous blue spots occur on the hinder half of the body and soft dorsal and caudal fins. The general colour is darker than in younger specimens, this being most noticeable in the ventral and anal fins, which are of greenish-black hue. This phase is represented in fig. 2, and approaches the specimens named *Parma microlepis* by Günther.

The adult, which attains a length of 160 mm., is wholly black, with the exception of the white opercular patch which is persistent. Traces of the dorsal ocellus and supra-caudal blotch may also exist.

The adult is represented in fig. 3, and such examples owe to Günther the name *Parma squamipinnis*.

Chief among the changes incident to growth may be mentioned the increased depth of the body, the reduced size of the eye and the narrowing of the preorbital.



The generic named *Parma*, Günther, is here regarded as synonymous with *Hypsipops*, Gill. Some notes on this question will be found in an earlier issue of the Records.<sup>11</sup>

The synonymy of the species would appear to be as follows:—

HYPSIPOPS MICROLEPIS, Günther.

*Glyphisodon biocellatus*, Bennett, Proc. Zool. Soc., xxvii., 1859, p. 222, Pisces, pl. ix. (not *G. biocellatus*, Cuvier and Valenciennes.)

*Parma microlepis*, Günther, Cat. Fish. Brit. Mus., iv., 1862, p. 57.

*Parma squamipinnis*, Günther, loc. cit., pp. 58 and 505.

*Glyphidodon australis*, Steindachner, Sitzb. Akad. Wiss. Wien, lvi., p. 328.

*Glyphidodon brownriggii*, Waite, Proc. Linn. Soc. N. S. Wales, (2), ix., 1894, p. 219. (not *Chetodon brownriggii*, Bennett).

Loc.—This species is common in Port Jackson and neighbouring waters, whence the examples studied and figured were taken. Mr. Woodward's specimens were obtained at Houtman's Abrolhos.

PSEUDOLABRUS PUNCTULATUS, Günther.

*Labrichthys punctulata*, Günther, Cat. Fish. Brit. Mus., iv., 1862, p. 118.

(Plate xiii.)

Mr. Woodward forwards specimens of this species from Mandurah; Castelnau<sup>12</sup> recorded it from the Western State and the Australian Museum possesses examples taken in South Australian waters.

In one specimen, undoubtedly of this species, the pale blue spots cannot be detected, and have indeed almost faded from all. In the absence of more stable points of difference we may assume that Castelnau's *Labrichthys edelensis*<sup>13</sup>, as he himself hinted, represents an example so faded.

The root of this latter specific name is used several times by Castelnau in his paper on the Fishes of Western Australia. His genus *Edelia* is re-diagnosed by Mr. J. D. Ogilby<sup>14</sup>, who writes:—“*Deriv. ign.*” Though I regard a zoological name as a name only, without significance, Mr. Ogilby carefully studies the etymology, but in this instance failed to ascertain the origin of the name.

<sup>11</sup> Waite.—Rec. Austr. Mus., v., 1904, p. 169.

<sup>12</sup> Castelnau.—Proc. Zool. Soc. Vict., ii., 1873, p. 138.

<sup>13</sup> Castelnau.—Loc. cit., p. 137.

<sup>14</sup> Ogilby.—Proc. Linn. Soc. N. S. Wales, xxiv., 1899, p. 176.

In R. H. Major's "Early Voyages to Terra Australis"<sup>15</sup>, we read:—"It would seem that another of the outward bound ships referred to in the Dutch recital, as visiting the coasts of New Holland, was commanded by Edel, and the land there discovered, which was on the west coast, was named the land of Edel. From Campbell's edition of Harris's voyages we learn that this discovery was made in 1619."

PSEUDOLABRUS TETRICUS, *Richardson*.

*Labrus tetricus*, Richardson, Proc. Zool. Soc., 1840, p. 25 ;  
Voy. "Ereb. and Terr.", Fishes, 1848, p. 126, pl. lv., fig. 1.

*Labrichthys bostockii*, Castlenau, Proc. Zool. Soc. Vict., ii., 1873,  
p. 137.

The examples forwarded from Mandurah are unquestionably identical with that described by Castlenau. The lower caudal ray is long equally with the upper one, and though I do not find that the vertical fins have the fine blackish edge described by Günther, the black spot at the upper pectoral base is present. In Richardson's figure the ventral is inserted too high on the body so that the distance between its base and that of the pectoral is not sufficiently great. The pectoral is illustrated as having a rounded margin, in our examples it is sinuous, with the upper rays much the longer. As the drawing is structurally incorrect in respect to the ventral, we may doubt its accuracy in respect to the pectoral and caudal also.

PSEUDOLABRUS GUENTHERI, *Bleeker*.

*Pseudolabrus guentheri*, Bleeker, Versl. Med. Kon. Akad. Weten.,  
xiv., 1862, p. 126.

Loc.—Fremantle.

HARPE VULPINA, *Richardson*.

*Cossyphus vulpinus*, Richardson, Proc. Zool. Soc., 1850, p. 71.

Loc.—Houtman's Abrolhos.

OPHTHALMOLEPIS LINEOLATUS, *Curier & Valenciennes*.

*Julis lineolatus*, Cuvier and Valenciennes, Hist. Nat. Poiss., xiii.,  
1839, p. 436.

Loc.—Houtman's Abrolhos.

---

<sup>15</sup> Major.—Early Voy. to Terra Austr., 1859, p. lxxxvi.

ODAX RICHARDSONII, *Günther*.

*Odax pullus*, Cuvier and Valenciennes, Hist. Nat. Poiss., xiv., 1839, p. 304, pl. ccccviii. (not *Forster*).

*Julis? dringii*, Richardson, Icon. Pisc., 1843, p. 6, pl. iii., fig. 1.

*Odax richardsonii*, Günther, Cat. Fish. Brit. Mus., iv., 1862, p. 241.

I have previously recorded this species from Western Australia; the examples now in hand were taken off Houtman's Abrolhos. It may be pointed out that those authors, who, would accept a drawing as the basis of a description, should use Richardson's name *Odax dringii* in preference to the later one of *Günther*.

The drawing is very defective and led Richardson, against his better judgment, to ascribe the fish to the genus *Julis* instead of *Odax*: he was impelled to this course mainly from comparison with a Chinese drawing!

OLISTHOPS CYANOMELAS, *Richardson*.

*Olisthops cyanomelas*, Richardson, Ann. Mag. Nat. Hist., (2), vii., 1851, p. 291.

*Loc.*—Houtman's Abrolhos.

HETEROSCARUS FILAMENTOSUS, *Castelnaud*.

*Heteroscarus filamentosus*, Castelnaud, Proc. Zool. Soc. Vict., i., 1872, p. 245.

*Loc.*—Houtman's Abrolhos.

CARANX SPECIOSUS, *Forsk.*

*Scomber speciosus*, Forskal, Descr. Anim., 1775, p. 54.

*Loc.*—Fremantle.

CARANX ARMATUS, *Forsk.*

*Sciaena armata*, Forskal, Descr. Anim., 1775, p. 53.

*Loc.*—Fremantle.

TRACHINOTUS BAILLONII, *Lacépède*.

*Casiomorus baillonii*, Lacépède, Hist. Nat. Poiss., iii., 1802, p. 93, pl. iii., fig. 1.

*Loc.*—Mandurah.

BRAMICHTHYS, *gen. nov.**Family* BRAMIDÆ.

Body ovate, compressed, covered with moderate cycloid scales, lateral line present, complete. Mouth wide, oblique; the lower jaw the longer; a band of minute teeth, scarcely perceptible to the touch, in each jaw, teeth also present on the vomer, palatines and tongue. No œsophageal teeth. Maxillary broad, scaly. Opercle with two flat points, preopercle entire. Snout broad, head not declivous, supraoccipital crest well developed, but not extending forward beyond the eyes.

Dorsal and anal fins long, the anterior lobes elevated and falcate, the first spine of the former, behind the vertical of the ventral fin. The dorsal fin has five spines and about twenty-nine rays, the anal three (? or four) spines and about thirty rays. In both fins the spines are closely adnate to the respective rays. The ventrals are small, placed below the base of the pectorals, with one spine and five rays. The pectorals are placed in the lower half of the body. The vertical fins densely clothed with small scales. Branchiostegals seven, caudal peduncle of moderate depth, not slender.

BRAMICHTHYS WOODWARDI, *sp. nov.*

(Plate xiv.)

D. v. 29; A. iii. (? iv.) 30; V. i. 5; P. 16; C. 17 + 6. L. lat. 50,  
L. tr. 7/20.

Length of head 3.3; height of body at the origin of the dorsal fin 1.85 in the total; eye very large, its diameter half the length of the head; snout short 5.1; and length of caudal 5.4 in the same. Interorbital space very convex, twice the length of the snout. Opercular margins smooth. Lower profile slightly more convex than the upper.

The dorsal fin begins well behind the vertical of the opercle, the spines are closely adnate to the soft portion and successively increase in height, the fifth being equal to the diameter of the eye: the anterior rays are much higher, the second being three-fourths more, or 1.25 in the length of head; following the lobed portion the rays are short and the base of the whole fin is slightly more than half the total length. The anal fin is similar in form and length, but occupies a slightly more posterior position: the sequence of the anal spines suggests that one, the second, has been lost, the third existing spine is of the same length as the fifth dorsal. The ventrals are short and do not reach the anal; the spine is a little longer than half the diameter of the eye.

The pectoral is falcate, its third and fourth upper rays a little less than the head in length. The caudal fin is deeply cleft but not forked as in *Brama*, the peduncle is relatively deep being but little less than the diameter of the large eye.

*Scales*.—The scales are simply cycloid, those above the lateral line arranged obliquely upwards. The lateral line commences with a strong curve to beneath the dorsal spines, whence, it runs almost straight to the end of the caudal rays.

*Colours*.—The colour appears to have been silvery, the fins are dark brown, without markings.

The general habit of this species suggests that it is an inhabitant of somewhat deep water.

I have pleasure in associating with this interesting fish, the name of Mr. Bernard H. Woodward, Curator of the Western Australian Museum.

Length 172 mm.

*Loc*.—One example from Mandurah.

PARALICHTHYS MUELLERI, *Klunzinger*.

*Pseudorhombus mülleri*, Klunzinger, Arch. für Naturg., 1872, p. 40; Sitzb. Akad. Wiss. Wien, lxxx., 1879, p. 407, pl. ix., fig. 2.

Very little colour appears to be developed in this species, but as most of the scales are lost in the two examples forwarded, precise information is not available. A dark spot, probably an ocellus, is present on the lateral line at the beginning of the last third of the body. The figure quoted, represents either a dextral example, or was reversed in drawing. The specimens were trawled between Fremantle and Houtman's Abrolhos.

CYNOGLOSSUS BROADHURSTI, *sp. nov.*

(Plate viii., fig. 2.)

D. 107; A. 86; C. 10; L. lat. 88; L. tr. *inter* L. lat. 13.

Length of head 5.77; depth of body 3.9 in the total length; diameter of eye 8.2; and length of snout 3.0 in the head.

The eyes are situated about half a diameter apart, the upper being a little in advance of the lower. One nostril is placed between the eyes, the other in front of the lower eye. Mouth strongly curved, its angle in advance of the middle of the head, reaching to below the centre of the lower eye. Lips not fringed. Rostral hook very short. Opercle oblique, notched behind.

*Teeth*.—Minute, present on the blind side only.

*Scales*.—On the left side strongly ctenoid, each scale with from three to five spines; scales on the blind side cycloid. Two lateral lines on the left side, the lower passes from the snout, above the eye, to the tip of the caudal. There are eighty-eight pierced scales along this line, posterior to the preopercle. The upper lateral line commences on the rostral hook and follows the profile of the head to the dorsal edge which it skirts to the base of the hundred and first ray, and it traverses the space between this and the next one. A vertical line of pores connects the upper and lower lateral lines and is continued round the margin of the preopercle whence a branch is given off at its angle to the opercle. One lateral line only on the blind side.

There is a single ventral fin only and the pectorals are obsolete. The dorsal fin commences on the front margin of the head and is confluent with the caudal, as is also the anal.

*Colour*.—Uniform brown, without markings.

Five examples received, the largest of which measures 270 mm. in length.

Structurally this species appears to be nearest allied to *C. borneensis*, Günther, differing in the proportions of the head and body, also in the absence of markings.

This is the only species of the genus *Cynoglossus*, as restricted, so far found in Australian waters, and with it I connect the name of Mr. F. C. Broadhurst who was jointly instrumental in procuring the collection of fishes dealt with in this paper.

*Loc*.—All were taken in the trawl off Carnarvon to the northward of Houtman's Abrolhos.

#### SYNANCIDIUM HORRIDUM, *Linnaeus*.

*Scorpaena horrida*, Linnaeus, Syst. Nat., ed. xii., 1766, p. 453.

*Loc*.—Houtman's Abrolhos.

#### NEOSEBASTES PANDA, *Richardson*.

*Scorpaena panda*, Richardson, Ann. Mag. Nat. Hist., ix., 1842, p. 216.

*Loc*.—Houtman's Abrolhos.

#### PTERYGOTRIGLA POLYOMMATA, *Richardson*

*Trigla polyommata*, Richardson, Proc. Zool. Soc., 1839, p. 96.

*Loc*.—Fremantle.

CHELIDONICHTHYS KUMU, *Lesson & Garnot.*

*Trigla kumu*, Lesson and Garnot, Voy. "Coquille," 1830, pl. xix.

*Loc.*—Houtman's Abrolhos ; Fremantle.

PARAPERCS NEBULOSUS, *Quoy & Gaimard.*

*Percis nebulosus*, Quoy and Gaimard, Voy. "Uranie et Physicienne," 1825, p. 349.

*Loc.*—Mandurah.

PATÆCUS FRONTO, *Richardson.*

*Patæcus fronto*, Richardson, Ann. Mag. Nat. Hist., xiv., 1844, p. 280.

Some remarks on the synonymy of this species will be found under the heading of *P. maculatus*.

*Loc.*—The example forwarded was trawled between Fremantle and Houtman's Abrolhos.

PATÆCUS MACULATUS, *Günther.*

*Patæcus maculatus*, Günther, Cat. Fish. Brit. Mus., iii., 1861, p. 292.

(Plate xv.)

The specimen forwarded was obtained at Fremantle, the type locality, and agrees quite well with the original description, differing in fact, as far as ascertainable, only by having thirty-two in place of thirty-one dorsal rays, of which twenty are spinous ; the first is extremely short, in front of the base of the second spine, and the third is longest.

The caudal has nine rays, the lower of which are shorter and thicker than the upper ones.

The tubercle described as being midway between the eye and the end of the snout is perforate and constitutes the posterior nostril, the anterior one lies in another smooth area nearer the mouth.

A Tasmanian example further differs by having thirty-three dorsal spines and especially in the length of the pectoral fin, which is longer than in the Western Australian fish, and almost as long as the head. The body also is relatively deeper ; these slight variations may be of individual or local import only. In neither specimen can I trace the lateral line described ; a non-porous ridge is possibly referred to. The Western Australian specimen is here figured natural size : its total length being 184 mm. It is thus much larger than either the type (80 mm.) or Castelnau's specimen (90 mm).

Steindachner<sup>15</sup> identified a specimen from St. Vincent's gulf with *Pataecus maculatus*, but evidently misunderstood the sentence:—"The dorsal fin is perfectly continuous, extending from the snout to the middle of the caudal fin."

In his example, as figured, the dorsal is free from the caudal fin and is attached to the middle of the slender peduncle. To emphasise this peculiarity he proposed the sub-genus *Neopataecus*.

This author placed *P. waterhousii*, Castelnau<sup>16</sup>, as a synonym of *P. maculatus*, but judging by the radial formula and the condition of the caudal rays, it is equally distinct from that species but identical with Steindachner's example. As the generic name *Neopataecus* was nominally founded on *P. maculatus*, though actually on a specimen of another species, it may, without violation of zoological nomenclature, accompany the latter, the name of which would therefore be *Neopataecus waterhousii*, Castelnau.

In 1890 Mr. R. M. Johnston published a complete list of Tasmanian Fishes, and included *Pataecus armatus*, Günther; I have not, so far, found any other reference to this species, and am inclined to regard it as a manuscript name, or, seeing that we have an example of *P. maculatus* from Tasmania as a *lapsus calami* for that name. Some further confusion in respect to the species of this genus is apparent. Richardson described *P. fronto*, the type, as exhibiting the dorsal formula 24/16. Günther, by error, prints thirty instead of forty, and appears to have been himself misled thereby, for he describes as a new species *P. subocellatus* from South Australia. A careful comparison fails to reveal any essential differences between the two, such being reducible to a variation of one dorsal and one anal ray.

Macleay<sup>17</sup> perceived that an error had been made, but failed to elucidate the difficulty. Of *P. maculatus* he writes:—"Dr. Günther's description of this fish cannot be accurate, or its resemblance to *fronto* must be very slight. It will probably be found that for D. 31 we should read D. 41."

An obvious misprint in Richardson's description "A. 11/15." is corrected by Macleay to "A. 11/5."

The following represents my conception of the synonymy as far as I am in a position to read it. Not having access to the *Anzeiger Akad. Wiss. Wien.*, I am unaware if *Neopataecus* was first characterised there or in the *Sitzungsberichte*.

<sup>15</sup> Steindachner.—Sitzb. K. Akad. Wiss. Wien, lxxxviii., 1884, p. 1087. pl. vii., fig. 3.

<sup>16</sup> Castelnau.—Proc. Zool. Soc. Vict., i., 1872, p. 244.

<sup>17</sup> Macleay.—Proc. Linn. Soc. N. S. Wales, vi., 1881, p. 31.



PATÆCUS, *Richardson*, 1844.

Ann. Mag. Nat. Hist., xiv., 1844, p. 280.

1. *P. fronto*, Richardson, *loc. cit.*, and Voy. "Ereb. & Terr.," Ichth., 1845, p. 20, pl. xiii.; Günther, Cat. Fish. Brit. Mus., iii., 1861, p. 292, and Study of Fishes, 1880, fig. 227; Macleay, Proc. Linn. Soc. N. S. Wales, vi., 1881, p. 30.  
*P. subocellatus*, Günther, Proc. Zool. Soc., 1871, p. 665, pl. lxxiv.; Macleay, Proc. Linn. Soc. N. S. Wales, vi., 1881, p. 31.
2. *P. maculata*, Günther, Cat. Fish. Brit. Mus., iii., 1861, p. 292; Castelnau, Proc. Linn. Soc. N. S. Wales, ii., 1878, p. 231; Macleay, Proc. Linn. Soc. N. S. Wales, vi., 1881, p. 31; Waite, *ante* p. 75, pl. xv. ? *P. armatus*, Günther (*vide* Johnston), Proc. Roy. Soc. Tasm., 1890 (1891), p. 33.
3. *P. vincentii*, Steindachner, Anz. K. Akad. Wiss. Wien, 1883, p. 195, and Sitzb. K. Akad. Wiss. Wien, lxxxviii., 1884, p. 1085, pl. vii., fig. 2.

NEOPATÆCUS, *Steindachner*, 1883.

? Anz. K. Akad. Wiss. Wien, 1883.

4. *N. waterhousii*, Castelnau, Proc. Zool. Soc. Vict., i., 1872, p. 244; Macleay, Proc. Linn. Soc. N. S. Wales, vi., 1881, p. 31.  
*P. maculatus*, Steindachner (not Günther), *loc. cit.* & Sitzb. K. Akad. Wiss. Wien, lxxxviii., 1884, p. 1087, pl. vii., fig. 3.

DIPULUS, *gen. nov.**Family* BROTLIDÆ.

General habit of *Gobioides*. Body greatly elongate, compressed behind, naked. Head small, naked, not spinose, no external eyes; mouth small, slightly oblique, no barbels, jaws equal; teeth small in bands, present in both jaws, on the vomer and palatines. Large pores in front of the snout and lower jaws, surrounded by folds of membrane probably tactile. Branchiostegals six, no pseudobranchiæ. Gill membranes wide, united, not free from the isthmus. Dorsal and anal fins low, not differentiated from the caudal. Pectorals normal; ventrals small, close together each an undivided filament near to the humeral symphysis. Vent a transverse opening approaching the middle of the body. Urogenital orifice with distinct external opening, bounded by very large transverse labia, at least in the male.

This genus appears to be nearest allied to *Aphyonus*, Günther<sup>18</sup>, and *Sciadonus*, Garman<sup>19</sup>. From the former it is immediately distinguishable by its elongate form, complete dentition and united gill-membranes; the latter character and, among others, the non-pedicilate pectoral serve to separate it from *Sciadonus*.

<sup>18</sup> Günther.—Ann. Mag. Nat. Hist., (5), ii., 1878, p. 22.

<sup>19</sup> Garman.—Mem. Mus. Comp. Zool. Harvard, xxiv., 1899, p. 171.

DIPULUS CÆCUS, *sp. nov.*

(Plate xi., fig. 2.)

Length of head 8·3 in the total, its depth equal to that of the body, or 1·7 in its length. The width of the head is slightly more than its depth and much greater than the thickness of the body.

The snout is very tumid, its anterior profile almost vertical; in company with the front portion of both upper and lower jaws it bears a number of large pores, surrounded by folds and flaps of membrane (see fig. 2a).

Simple pores are, in addition, present on other parts of the head, notably a pair above the expanded end of the maxilla, and a series at long intervals along the rami of the mandible. The posterior nostrils are very evident, situated near the end of the snout, and have a supero-lateral aspect, the anterior ones, which may not be distinguished from the pores referred to, appear to be placed on the front aspect of the snout within the dermal folds. Eye not visible. The orbit, as ascertained through the skin, lies wholly within the anterior third of the head, its diameter being half the length of the snout.

*Teeth.*—The teeth are very small and sharply pointed, and are present in bands in both jaws, on the vomer and palatines.

The maxilla is greatly broadened behind, and extends to far beyond the hinder margin of the orbit.

*Fins.*—The dorsal fin begins behind the base of the pectoral, its distance from the snout less than one-sixth of the total length, caudal excluded. Origin of anal nearer to the snout than to the base of the caudal. Pectoral normal, less than half the length of the head. The ventrals consist each of a simple ray placed close together, in advance of the pectoral, they are very short, equalling the snout in length. Vent situated far behind the head, its distance therefrom three-fourths the post-ventral length. It is quite distinct from the uro-genital orifice, which is bordered before and behind with very large labia. Immediately within the anterior lip is a pair of large leaf-like appendages at the base of which lies the penis.

The folds and flaps of membrane surrounding the pores on the snout and mandible recall the condition in some of the leaf-nosed Bats. The analogy may indeed be very close: the fish is blind and the Rhinolophidæ hunt in the dark.

“In their habits they appear to differ from other insectivorous Bats without nasal appendages, inhabiting the same regions, by coming out later in the evening, or when the sun has completely gone down below the horizon. This peculiarity is probably connected with their possession

of special organs of touch in the complicated nose-leaf, and delicately formed ears and membranes, which may permit them to commence and continue their hunt for insect prey at a time when other Bats have retired to their sleeping-places."<sup>20</sup>

The large size of the genitalia and the development of special organs in this fish, indicates that copulation actually takes place, a circumstance also distinctly correlated with blindness.

*Loc.*—The single specimen forwarded is a male, 152 mm. in length, and was taken off Fremantle.

*MONACANTHUS CHINENSIS*, Bloch.

*Balistes chinensis*, Bloch, *Ichty.*, ii., 1787, p. 29, pl. lii., fig. 1.

*Loc.*—Fremantle.

*MONACANTHUS MEGALOURUS*, Richardson.

*Monacanthus megalourus*, Richardson, *Icon. Pisc.*, 1843, p. 5, pl. i., fig. 3.

*Loc.*—Houtman's Abrolhos.

*PSEUDOMONACANTHUS GALII*, *sp. nov.*

(Plate xvi.)

Length of head 3·2; height of body at the first anal ray 2·8; and length of caudal 5·1 in the total. The eye is almost round and lies midway between the end of the snout and the first dorsal ray; its diameter is one-fifth the length of the head; the interorbital space is convex and contained 4·1 times in the same.

The gill opening is oblique and placed immediately beneath the eye, it is distant therefrom about the diameter of the orbit. The nostrils are situated in a shallow depression half a diameter in advance of the eye, each in a short cutaneous tube.

The head is deeper than long, a little concave on the snout, slightly tumid above the eye; the lower profile is moderately straight to the pelvic spine.

The dorsal spine is placed above the last third of the orbit, and nearer to the rays than the end of the snout, it is without distinct barbs, the front and sides being granular; its length approaches half that of the head. The rays are highest medially, the longest being one-fourth the length of the head. The anal arises beneath the sixth dorsal ray and is continued posteriorly beyond that fin to which it is similar in form, but its rays are not quite so high.

<sup>20</sup> Dobson.—*Cat. Chiroptera Brit. Mus.*, 1878, p. 100.

The ventral process is but little extensible, and its spine is small and granular. The pectoral is rounded and its third ray is one-fifth longer than the eye. The caudal is short and rounded, the peduncle is stout, its height being half the length of the fin.

The whole of the head and body, the bases of the vertical fins and the outer aspect of the alternate caudal rays uniformly covered with small bifurcated spines, so densely placed as to give a velvety feel to the touch.

*Colours.*—The colours are not well preserved, but as far as ascertainable are as follows:—Uniformly dark brown, the body marked with narrow longitudinal black lines about as wide as or narrower than the interspaces. Immediately behind the head they are about twelve in number but are successively lost posteriorly and none attain to the caudal peduncle, the head and lower fourth of the body, except in the region of the pelvic spine, are without markings. Fins pale brown.

Total length 300 mm. Taken at Sharks Bay.

At the request of Mr. Woodward, this fish is named after Mr. C. F. Gale, Chief Inspector of Fisheries, Western Australia.

*PSEUDOMONACANTHUS HIPPOCREPIS, Quoy & Gaimard.*

*Balistes hippocrepis*, Quoy and Gaimard, Voy. "Uranie et Physicienne," 1824, p. 212.

*Loc.*—Mandurah; Fremantle; Houtman's Abrolhos; Rottnest Island.

*PSEUDOMONACANTHUS GRANULATUS, Shaw.*

*Balistes granulatus*, Shaw, in White's Voy. N. S. Wales, 1790, p. 295, fig. 2.

*Loc.*—Mandurah; Fremantle; Houtman's Abrolhos.

*PSEUDOMONACANTHUS BROWNII, Richardson.*

*Aleuterius brownii*, Richardson, Voy. "Ereb and Terr.," Ichth., 1846, p. 68.

*Loc.*—Fremantle.

*CHÆTODERMIS PENICILLIGERUS, Cuvier.*

*Balistes penicilligerus*, Cuvier, Règne Anim., ed. 2., ii, 1829, p. 374 (footnote), and iii., 1830, p. 433, pl xi., fig. 3.

Castelnau<sup>21</sup> recorded this species from Fremantle, whence we have a fine example measuring 27 mm.

Mr. C. T. Regan<sup>22</sup> does not admit *Chaetodermis* as a valid genus and remarks on the similarity of the species to *Monacanthus tomentosus*.

CHÆTODERMIS MACCULLOCHI, *sp. nov.*

(Pl. xvii.)

D. ii., 27 ; A. 26 ; P. 12 ; C. 12.

Length of head 2·7 ; height of body at the vent, equal to the length of the caudal and 2·2 in the total. The eye lies nearer to the dorsal rays than to the end of the snout and is 4·4 in the length of the head : the interorbital space is 4·0 in the same.

The gill opening is nearly vertical, it is placed beneath the posterior margin of the eye, and is nearly one-half longer than its diameter. The nostrils are simple pores placed close together in a naked area well in front of the eye.

Head deeper than long, its upper and lower profiles, to the dorsal and ventral spines respectively, perfectly straight.

The body is elongate, strongly compressed, its upper and lower borders very slightly curved. The dorsal spine is placed wholly behind the eye and midway between the end of the snout and the middle dorsal rays. It is beset with strong lateral barbs, directed downward ; at the upper base of each arises a filament as long as the diameter of the eye and bifid near the tip. The rays are long and rise gradually to about the twentieth which is half the length of the head ; the posterior edge is gently rounded. The anal arises beneath the seventh dorsal ray and extends a little beyond its posterior insertion, it is otherwise quite similar. The ventral process is scarcely depressible but its terminal spine is movable. It is beset with barbs and filaments. The pectoral is rounded, its longest rays twice the diameter of the eye. The caudal is markedly acuminate, the central rays being twice the length of the outer ones. It is peculiar inasmuch as its rays are homacanthus (if I may use the term in this connection) there being no alternation of arrangement and all of equal thickness ; the peduncle is flattened above and below, and its depth is equal to the diameter of the eye.

The lips, space around the nostrils and gill-openings are naked, otherwise the head is densely covered with rosette-like

---

<sup>21</sup> Castelnau.—Proc. Zool. Soc. Vict., ii., 1873, p. 147.

<sup>22</sup> Regan.—Proc. Zool. Soc., 1902, p. 289.

scales. On the body they merge into simple prominent sub-recumbent spines arranged in close longitudinal rows, which extend to the bases of the caudal rays. The head and body bear distant branched filaments, there is a series along the upper and lower profile of the head and a close series between the ventral spine and the anal fin.

Total length 230 mm.

*Loc.*—Houtman's Abrolhos.

*Colours.*—The specimen is evidently much discoloured and is now uniform pale brown, with scattered dark markings, principally disposed below the base of the dorsal rays. A larger spot may be traced above the upper pectoral rays. The caudal bears a few dark spots.

The contour of this fish sufficiently distinguishes it from that of the only other known species. It has the shape of a double-rhomboid, one figure of which is formed by the head and body and the other by the tail. The hinder profiles of the body produce an acute angle, whereas in *C. penicilligerus*, Cuvier, they form a semicircle; the tail of the latter, also, is not produced as in the new species.

I associate with the species the name of Mr. A. R. McCulloch to whom I owe the figure of this and the other species illustrating the paper.

ARACANA LENTICULARIS, *Richardson*.

*Ostracion lenticularis*, Richardson, Proc. Zool. Soc., 1841, p. 21.

*Loc.*—Fremantle.

ARACANA AURITA, *Shaw*.

*Ostracion auritus*, Shaw, Nat. Misc., ix., 1798, pl. cccxxxviii.

*Loc.*—Fremantle.

SPHÆROIDES SCCELERATUS, *Gmelin*.

*Tetraodon sccleratus*, Gmelin, Syst. Nat., ed. xiii., 1789, p. 1444

*Loc.*—Fremantle.

MINERALOGICAL NOTES: No. II.—TOPAZ, BARITE,  
ANGLESITE, CERUSSITE, AND ZIRCON.

By C. ANDERSON, M.A., B.Sc., Mineralogist.

(Plates xviii.—xx.)

TOPAZ.

EMMAVILLE, NEW SOUTH WALES.

Since a description and figures of topaz crystals from Emma-ville was published,<sup>1</sup> Mr. D. A. Porter has presented to the Trustees the specimen represented in Pl. xviii., Fig. 1. It is a typical and finely developed example of the crystalline habit of topaz from this locality, and, as it is somewhat larger than the best crystals hitherto examined, it is possible to represent the faces in approximately their actual relative proportions. As usual there is a comparatively rich prism zone, with the form *m* (110) greatly predominating. Each of the prisms has four faces present, but the pinacoid *b* (010) has only one. The three domes have each the full number of faces. Of the pyramids *o* (221) and *x* (243) have but three faces, while *u* (111) and *i* (223) have four. The faces are with few exceptions smooth and brilliant and give excellent reflections. The crystal measures  $9\frac{1}{2}$  mm.  $\times$   $5\frac{1}{2}$  mm.  $\times$  4 mm. The mean co-ordinate angles obtained are as follows:—

---

<sup>1</sup> Anderson—Rec. Austr. Mus., v., 1904, pp. 296-299, pl. xxxix., figs. 1-3

Forms.		Measured.				Calculated.				Error.	
		$\phi$		$\rho$		$\phi$		$\rho$		$\phi$	$\rho$
		°	'	°	'	°	'	°	'	'	'
<i>c</i>	001	—	—	—	—	—	—	—	—	—	—
<i>b</i>	010	0	15	90	5	0	0	90	0	15	5
<i>m</i>	110	62	4	90	2	62	8	90	0	4	2
<i>M</i>	230	51	34	90	1	51	35	90	0	1	1
<i>l</i>	120	43	24	90	3	43	25	90	0	1	3
$\pi$	250	37	8	90	0	37	7	90	0	1	0
<i>g</i>	130	32	16	90	0	32	14	90	0	2	0
<i>d</i>	201	89	59	60	59	90	0	61	0	1	1
<i>f</i>	021	0	1	43	37	0	0	43	39	1	2
<i>y</i>	041	0	0	62	19	0	0	62	20	0	1
<i>o</i>	221	62	8	63	52	62	8	63	54	0	2
<i>u</i>	111	62	8	45	36	62	8	45	35	0	1
<i>i</i>	223	62	6	34	15	62	8	34	14	2	1
<i>x</i>	243	43	27	41	14	43	25	41	12	2	2

In this as in succeeding tables the calculated angles are those given by Goldschmidt in his *Krystallographische Winkeltabellen*.

Since a considerable number of angular measurements of topaz crystals from Emmaville are now available, it may be of interest to calculate the corresponding axial ratios, especially as Penfield and Minor<sup>2</sup> have shown that the ratios vary with the isomorphous replacement of fluorine by hydroxyl. For this purpose the angles were carefully revised, the best measurements selected, and means taken. The forms chosen from measurements on six crystals and the mean angles obtained are given in the table below; as it was judged that the prism *m* and the pyramid *u* yield the most reliable data, the corresponding values for *a* and *c* are counted twice in finding the mean ratios.

<sup>2</sup> Penfield and Minor—*Amer. Journ. Sci.*, *xlvii.*, 1894, p. 387.



Form.		$\phi$			$\rho$			$a$	$c$
		°	'	"	°	'	"		
<i>m</i>	110	62	7	38.5				.5288615	
<i>l</i>	120	43	25	5				.5284015	
<i>g</i>	130	32	14	24				.5285428	
<i>u</i>	111	62	7	38	45	34	40	.5288646	.4769763
<i>f</i>	021				43	39			.4770300
<i>y</i>	041				62	19	30		.4767101
Mean		...			...			0.5287328	0.4769232

The calculated values of  $a$  and  $c$  agree fairly closely with Koksharov's ratios  $a : b : c = 0.528542 : 1 : 0.476976$ , determined on Russian topaz and usually taken as the standard.

Pl. xix., fig. 1 is a stereographic projection showing the distribution of all faces that have been identified on Emmaville topaz.

#### OBAN, NEW SOUTH WALES.

Mr. D. A. Porter recently presented to the Trustees a fine large crystal of topaz from Oban. It measures 4 cm.  $\times$  4 cm.  $\times$  3 cm., and shows four forms not recognised on crystals from this locality hitherto examined, namely  $c$  (001),  $d$  (201),  $h$  (203), and  $X$  (043). It is shown in its natural development in Pl. xviii., fig. 2. The specimen is somewhat worn and the faces non-reflecting, but approximate measurements obtained with the contact goniometer leave no doubt as to the correctness of the determinations. There is but one face of  $X$  present, but all the others have the full number. One of the  $f$  (021) faces shows a distinct natural etching-figure. It takes the form of a raised semicircular area with its convexity directed towards the apex of the crystal, the base of the semicircle being parallel to the intersection of  $f$  and  $c$ .

#### MOUNT CAMERON, TASMANIA.

Through the kindness of Mr. W. F. Petterd, a well-known authority on the minerals of Tasmania, I have been enabled to

measure some fine specimens of crystallised Tasmanian minerals, including topaz from Mt. Cameron, Flinders Island, and Bell Mount.

At Mt. Cameron topaz is abundant in the stanniferous drift, but has not been found *in situ*. It is usually much worn, but some crystals well suited for crystallographic determination were sent to me by Mr. Petterd. Two crystals were determined on the goniometer, one a crystal measuring 12 mm.  $\times$  13 mm.  $\times$  12 mm. and of a greenish colour shown in Pl. xviii., fig. 3. It is fairly rich in prism faces, having *m* (110), *M* (230), *l* (120), and *g* (130) present; *l* predominates, but all are well marked faces and give fairly good images. The terminal faces are rather dull; only one face of *o* (221) is present. The co-ordinate angles obtained are given below.

Forms.		Measured.				Calculated.				Error.		
		$\phi$		$\rho$		$\phi$		$\rho$		$\phi$	$\rho$	
		o	'	o	'	o	'	o	'	'	o	'
<i>c</i>	001	—	—	—	—	—	—	—	—	—	—	—
<i>m</i>	110	62	5	89	56	62	8	90	0	3	4	
<i>M</i>	230	51	28	89	53	51	34	90	0	6	7	
<i>l</i>	120	43	17	89	55	43	25	90	0	8	5	
<i>g</i>	130	32	19	89	55	32	14	90	0	5	5	
<i>f</i>	021		6	43	35	0	0	43	39	6	4	
<i>y</i>	041		8	62	13	0	0	62	20	8	7	
<i>o</i>	221	61	57	62	53	62	8	63	54	11	11	
<i>u</i>	111	62	7	45	29	62	8	45	35	1	6	
<i>i</i>	223	62	7	34	13	62	8	34	14	1	1	

From another lot of small clear, colourless, crystals one was selected and its faces determined (Pl. xviii., fig. 4). It measures 7 mm.  $\times$  5 mm.  $\times$  5 mm., and in general habit resembles the last, but has fewer prism faces and has the rather rare pyramid *z* (243) fairly well developed but dull. The prism faces are striated and give only fair signals. Appended are the mean co-ordinate angles found.

Form		Measured.				Calculated.				Error.	
		$\phi$		$\rho$		$\phi$		$\rho$		$\phi$	$\rho$
		o	i	o	i	o	i	o	i	i	i
<i>c</i>	001	—	—	—	—	—	—	—	—	—	—
<i>m</i>	110	61	58	89	58	62	8	90	0	10	2
<i>l</i>	120	43	7	89	58	43	25	90	0	18	2
<i>f</i>	021		1	43	37	0	0	43	39	1	2
<i>y</i>	041		7	62	13	0	0	62	20	7	7
<i>u</i>	111	61	53	45	24	62	8	45	35	15	11
<i>i</i>	223	61	46	33	58	62	8	34	14	22	16
<i>x</i>	243	42	26	41	6	43	25	41	12	59	6

## FLINDERS ISLAND, TASMANIA.

Topaz from Flinders Island was first mentioned, I believe, by the late Rev. J. J. Bleasdale, D.D., who wrote: "This may be said of those [*i.e.*, topaz crystals] from Flinders Island that they possess very great fire and beauty when cut, and are nearly all of a pale yellowish shade in the rough." The best account of the occurrence is that of the late C. Gould, Government Geologist of Tasmania, who observed it whilst making a geological reconnaissance of the islands in Bass Strait.<sup>4</sup> The following paragraph gives an abstract of his observations.

It occurs in crystals and pebbles in great variety of form, colour and size, associated with zircon, tourmaline, cassiterite, etc. It is derived from the granite and may occasionally be obtained as fine crystals *in situ* along with crystallised quartz and felspar. It is abundant on the north-east side of Killisrankie Bay in a creek descending from the ranges and upon the beach; it also occurs in other parts of Flinders Island. The topaz has evidently been formed in veins of pegmatite which traverse the granite and vary from one to several feet in diameter. The colour varies from pure limpid to various shades of blue, pale pink, yellow, etc. Crystals are found up to several inches in diameter.

<sup>3</sup> Bleasdale—*Trans. Roy. Soc. Vict.*, vii., 1866, p. 70.

<sup>4</sup> Gould—*Proc. Roy. Soc. Tas.*, 1871 (1872), pp. 60-61.

A fine crystal (Pl. xviii., fig. 5) measuring 7 mm.  $\times$  9 mm.  $\times$  7 mm., and perfectly clear and colourless was measured on the goniometer. As the faces are very irregularly developed and one side of the crystal is broken, the crystal is drawn in ideal symmetry, but so as to show the habit as nearly as possible. The prisms  $m$  (110) and  $l$  (120) are about equal in size and striated, but the images are good. The brachydomes  $f$  (021) and  $y$  (041) are relatively small, while the macrodome  $d$  (201) is unusually large and brilliant. The base is large and smooth. The pyramid  $o$  (221) is small,  $u$  (111) and  $i$  (223) large and brilliant.

The co-ordinate angles found are tabulated below.

Form.		Measured.				Calculated.				Error.	
		$\phi$		$\rho$		$\phi$		$\rho$		$\phi$	$\rho$
		o	l	o	l	o	l	o	l	l	l
$c$	001	—	—	—	—	—	—	—	—	—	—
$m$	110	62	8	89	58	62	8	90	0	0	2
$l$	120	43	23	89	58	43	25	90	0	2	2
$f$	021		4	43	36	0	0	43	39	4	3
$y$	041		4	61	59	0	0	62	20	4	21
$d$	201	90	0	61	5	90	0	61	0	0	5
$o$	221	62	7	63	43	62	8	63	54	1	11
$u$	111	62	10	45	33	62	8	45	35	2	2
$i$	223	62	9	34	11	62	8	34	14	1	3

#### BELL MOUNT, MIDDLESEX, TASMANIA.

Mr. Petterd informs me that topaz occurs at Bell Mount in a very decomposed quartz-porphry, also as pebbles weathered out in the drift; it has not previously been recorded from this locality. Two crystals, both colourless and transparent, were examined; one is much worn and broken and unsuitable for goniometric determination. The other (Pl. xviii., fig. 6) has good prism and dome faces but the pyramids are dull and were measured in the position of maximum illumination. The base is absent. The crystal measures 13 mm.  $\times$  10 mm.  $\times$  11 mm.

Forms.		Measured.				Calculated.				Error.	
		$\phi$		$\rho$		$\phi$		$\rho$		$\phi$	$\rho$
		o	l	o	l	o	l	o	l	l	l
<i>m</i>	110	62	5	89	59	62	8	90	0	3	1
<i>l</i>	120	43	17	89	57	43	25	90	0	8	3
<i>f</i>	021		1	43	36		0	43	39	1	3
<i>u</i>	111	62	2	45	22	62	8	45	35	6	13

## BARITE.

Barite has for some time been known to occur at several points in the Triassic area in the neighbourhood of Sydney, both in the Hawkesbury Sandstone and in the succeeding Wianamatta Shales. It was first recorded by Mr. H. G. Smith who found it in a quarry near Cook River, five miles west from Sydney, in small well-formed crystals, consisting of almost pure barium sulphate with a trace of calcium.<sup>5</sup> Subsequently barite was found near Gosford Railway Station.<sup>6</sup> It has also been observed by Prof. T. W. E. David, Trustee, at Five Dock, associated with quartzite and in close proximity to a decomposed basalt dyke. It is found under similar conditions at Pymont Sandstone Quarries, and at Pennant Hills Quarries it occurs as veins in the basalt at a depth of over fifty feet. Prof. David believed that the barite found in the Sydney area originated probably from the basalt, numerous dykes of which traverse the sedimentary rocks.<sup>7</sup> He informs me, however, that he has now modified this opinion since observing how widespread is the distribution of barytes in the Permo-Carboniferous sedimentary rocks of the Northern and Southern Coal-fields as well as in the Triassic strata of New South Wales. He now attributes the barite of the Sydney area chiefly to decomposition of detrital barytic feldspars. Specimens from Macdonald Town and Thirlmere are in the Australian Museum collection.

<sup>5</sup> Smith—Proc. Linn. Soc. N. S. Wales, (2), vi., 1892, pp. 131-132.

<sup>6</sup> Baker—*Loc. cit.*, (2), vii., 1893, p. 328.

<sup>7</sup> David—Journ. Roy. Soc. N. S. Wales, xxvii., 1894, p. 407.

The crystals described in this paper are from the Wianamatta Shale at St. Peters, near Sydney. There are three specimens from this locality in the Museum collection, each carrying a number of crystals, but specimens sufficiently good for goniometric determination are found on only one. The crystals are either tabular on the basal pinacoid, or prismatic by extension parallel to the brachy-axis. The combinations are comparatively simple: of two crystals measured one showed the forms  $c$  (001),  $m$  (110),  $o$  (011),  $d$  (102), the other (Pl. xix., fig. 2) the forms  $c$  (001),  $b$  (010),  $m$  (110),  $o$  (011),  $d$  (102),  $z$  (111). This latter crystal measures approximately 3 mm.  $\times$  2 $\frac{1}{2}$  mm. on the basal pinacoid, and, like all the well formed specimens is quite transparent and colourless. The faces of  $b$  (010) are very small and were measured in the position of maximum illumination. Only one reliable measurement of the form  $z$  (111) was obtained. Below are the measured angles.

Forms.		Measured.				Calculated.				Error.	
		$\phi$		$\rho$		$\phi$		$\rho$		$\phi$	$\rho$
		o	l	o	l	o	l	o	l	l	l
$c$	001	—	—	—	—	—	—	—	—	—	—
$b$	010		10	90	0	0	0	90	0	10	0
$m$	110	50	45	89	57	50	49	90	0	4	3
$o$	011		9	52	38	0	0	52	43	9	5
$d$	102	90	2	38	45	90	0	38	51	2	6
$z$	111	50	50	64	7	50	49	64	18	1	11

### ANGLESITE.

#### MAESTRIE'S MINE, DUNDAS, TASMANIA.

Mr. W. F. Petterd says of this occurrence<sup>3</sup> "many of the crystals obtained at this mine are large and beautifully developed, occurring in masses of considerable size, sometimes containing massicot in the interstices and as a base. Commonly large lumps of galena are coated with anglesite, cerussite and massicot, presenting an appearance that has become fairly characteristic of

<sup>3</sup> Petterd—Min. Tasmania, 1893, p. 7.

this mine and the Comet adjoining." In the Museum collection there is one specimen from this locality, consisting of a group of well developed lustrous crystals in a vugh of galena, with powdery limonite. The crystals are of the general habit shown in Pl. xix., fig. 3. The crystal there represented measures 1.2 cm.  $\times$  1.9 cm.  $\times$  1 cm.; it is slightly broken at one end of the macro-axis, and the  $a$  (100) faces are strongly striated parallel to their intersection with  $m$  (110). The predominant forms are  $c$  (001),  $a$  (100), and  $m$  (110); the others are very narrow. Two faces of  $d$  (102) admitted of measurement, but the pyramids and the dome  $o$  (011) were determined from single faces. The image obtained from  $z$  (111) was very poor, the angles being measured in the position of maximum illumination. The measured and calculated angles are given in the following table:—

Form.		Measured.				Calculated.				Error.	
		$\phi$		$\rho$		$\phi$		$\rho$		$\phi$	$\rho$
		o	'	o	'	o	'	o	'	'	'
$c$	001	—	—	—	—	—	—	—	—	—	—
$a$	100	89	54	90	0	90	0	90	0	6	0
$m$	110	51	57	89	57	51	51	90	0	6	3
$d$	102	90	4	39	17	90	0	39	23	4	6
$o$	011	0	0	52	16	0	0	52	12	0	4
$z$	111	—	—	65	0	51	51	64	24	—	36
$y$	122	32	6	56	45	32	29	56	48	23	3

## MINE MERETRICE, NEW CALEDONIA.

There is one specimen with numerous crystals from this locality in the Museum collection. The anglesite crystals, which are small but beautifully and regularly developed, are embedded in a cavernous gossany matrix; they are transparent and either colourless or slightly yellowish, with a vitreous to greasy lustre. The habit is remarkably uniform, the dominant forms being  $c$  (001),  $m$  (110) and  $d$  (102). Two crystals were measured, one showing only these forms, the other further modified by the forms  $b$  (010),  $o$  (011),  $z$  (111),  $y$  (122), all with very small faces. (Pl. xix., fig. 4). The co-ordinate angles obtained agreed well with the calculated values.

## LEWIS PONDS, NEAR ORANGE, NEW SOUTH WALES.

This occurrence of anglesite is mentioned in the "Census of New South Wales Minerals" drawn up by a Committee of the Australasian Association for the Advancement of Science in 1890,<sup>9</sup> where the locality is given as the New Lewis Ponds Silver Mine, and it is said to be associated with cerussite and silver ores. On the specimen in the Australian Museum numerous crystals of anglesite are scattered over the surface of a crumbling, limonitous gossan. Many of the crystals are greenish in colour, and are said to contain copper. I was unable to prove the presence or absence of copper definitely on the quantity of material I felt justified in sacrificing, but it may be present in small amount. Anglesite with a green or blue tinge is commonly observed, and this may perhaps be due to an isomorphous mixture of anglesite with a small quantity of the anhydrous copper sulphate hydrocyanite, which crystallises in the orthorhombic system with axes and angles not far from those of the barite-anglesite group.

The Lewis Ponds crystals show two somewhat different habits; in one the predominant forms are  $c$  (001),  $m$  (110), and  $d$  (102), and the crystals are elongated along the macro-axis (Pl. xix., fig. 5); in the other, by increase in the size of  $z$  (111),  $m$  is reduced to a narrow plane, and the crystal is almost acutely terminated on the  $a$  and  $b$  axes (Pl. xix., fig. 6). The crystals of the second habit are much smaller than the others, the two shown in Pl. xix., figs. 5 and 6 measuring respectively 5 mm.  $\times$  8 mm.  $\times$  5 mm., and 3 mm. in diameter. Only the larger crystals are greenish, the smaller being colourless with a greasy lustre. The table below gives the mean co-ordinate angles obtained from the two figured crystals.

Forms.		Measured.		Calculated.		Error.	
		$\phi$	$\rho$	$\phi$	$\rho$	$\phi$	$\rho$
$c$	001	—	—	—	—	—	—
$m$	110	51 49	90 1	51 51	90 0	2	1
$d$	102	89 59	39 22	90 0	39 23	1	1
$z$	111	51 47	64 24	51 51	64 24	4	0

<sup>9</sup> Proc. Austr. Ass. Adv. Sci., ii., 1890, p. 207.



## CERUSSITE.

At the Magnet Mine, Tasmania, cerussite occurs in two different habits, long prismatic or tabular on the  $b$  (010) pinacoid (Pl. xx., fig. 1), and as flat tables parallel to the basal plane (Pl. xx., fig. 2). In both cases the crystals are twinned on the faces  $m$  (110) and  $m'''$  ( $\bar{1}\bar{1}0$ ) resulting in trillings of pseudo-hexagonal form. A specimen in the Museum collection furnished crystals of the first habit, while Mr. W. F. Petterd obligingly lent some examples of the other. An interesting feature is that the flat pseudo-hexagonal tables of the second habit are invariably contaminated with chromate of lead, doubtless in the form of crocoisite, which imparts to them a canary-yellow colour with occasional patches of red. The occurrence is well described by Mr. Petterd.<sup>10</sup>

"This attractive variety [habit ii.] of a common species is, so far as known, confined to the Magnet Mine, in the upper workings of which it is, although local, fairly abundant. It occurs in fractures and vughs in the gossan zone, but in bunches and sparsely attached as beautiful little crystals, generally in close association with crocoisite, but never so far as observation has gone intermixed with the normal form [of cerussite]; although this is somewhat abundant in its usual adamantine characteristic habit, often showing remarkably perfect development in stellar and cruciform triplet crystals."

*Habit i.* (Pl. xx., fig. 1.) The two crystals measured were essentially similar, being elongated along the vertical axis and tabular on the  $b$  (010) pinacoid. The same forms are present in both, namely  $c$  (001),  $a$  (100),  $b$  (010),  $m$  (110),  $r$  (130),  $i$  (021),  $x$  (102), and  $p$  (111). In the figure the breadth along the  $a$  axis is somewhat exaggerated, and the three individuals are drawn in equi-poise, though really only one is well-formed, the other two being quite subordinate. All the forms except  $b$  are relatively narrow and the prism zone is much striated and interrupted. Of the three individuals forming the trilling, I. is placed in the conventional position, while II. and III. are twinned on the faces (110) and ( $\bar{1}\bar{1}0$ ), respectively, of I. Thus the faces  $m$  and  $p$  are coplanar with  $m$  and  $p$ , while  $\bar{m}$  and  $\bar{p}$  are coplanar with  $m'''$  and  $p'''$ , and similarly at the other end of the  $a$  axis of I. but II. and III. have only one coplanar face, namely, the base  $c$ . The figure is similar to the well-known drawing by Schrauf<sup>11</sup>, but the

<sup>10</sup> Petterd—Rept. Secy. Mines Tas., 1903 (1904), pp. 76-77.

<sup>11</sup> Schrauf—Tschermak's Mineral. Mittheil., 1873, Heft iii., pp. 203-212, Pl. iii., fig. 2.

Magnet mineral has three more forms. The table of angles below gives the measured and calculated values for I. and also the observed angles belonging to forms on II. and III., as, owing to the small size and imperfect development of the crystals, on the goniometer it was impossible to distinguish the reflections belonging to the several individuals, and it was mainly from the angular measurements that the twinning structure was deduced.

Forms.		No. of Faces.	Measured.		Calculated.		Error.		
			$\phi$	$\rho$	$\phi$	$\rho$	$\phi$	$\rho$	
<i>c</i>	001	—	—	—	—	—	—	—	—
<i>a</i>	100	3	90 0	89 59	90 0	90 0	0	1	
<i>b</i>	010	4	0 4	89 56	0 0	90 0	4	4	
<i>m</i>	110	6	58 36	89 58	58 37	90 0	1	2	
<i>r</i>	130	5	28 39	89 56	28 39	90 0	0	4	
<i>i</i>	021	3	0 2	55 22	0 0	55 20	2	2	
<i>x</i>	012	2	0 1	19 51	0 0	19 52	1	1	
<i>p</i>	111	6	58 39	54 10	58 37	54 14	2	4	
$\bar{a}$	100	2	27 23	89 57	27 14	90 0	9	3	
$\bar{b}$	010	3	62 59	89 56	62 46	90 0	13	4	
$\bar{b}$	010	1	62 34	89 59	62 46	90 0	12	1	
$\bar{m}$	110	2	4 15	89 56	4 9	90 0	6	4	
$\bar{m}$	110	1	3 47	90 0	4 9	90 0	22	0	
$\bar{r}$	130	1	34 5	89 51	34 7	90 0	2	9	
$\bar{r}$	130	1	34 23	90 0	34 7	90 0	16	0	
$\bar{i}$	021	1	62 41	55 17	62 46	55 20	5	3	
$\bar{x}$	012	1	62 48	19 50	62 46	19 52	2	2	
$\bar{p}$	111	3	4 5	54 8	4 9	54 14	4	6	

*Habit ii.* (Pl. xx. fig. 2). The crystals with this habit differ from the others mainly in having a large basal plane, and in being greatly shortened along the vertical axis, the result being flat tables approaching the hexagonal form. That they are trillings

is at once apparent from the reëntrant angles on the edges, and the three systems of striations on the basal plane, which are well seen under the microscope, crossing at angles of approximately  $60^\circ$ , and running parallel to the brachy-axis of each individual. Crystals of a similar habit have already been observed in aragonite, but prismatic crystals seem more common with cerussite. One lot of isolated crystals of a pronounced yellowish colour average 6 mm. in diameter. A few smaller crystals measuring about 1 mm. in diameter, translucent, and of a much paler colour were obtained implanted on the matrix. These latter supplied the best measurements on the goniometer. The most prominent face after the basal plane is the pyramid  $o$  (112); only one doubtful angle could be referred to the prism  $r$ , which is accordingly not entered in the figure. The forms recognised are  $c$  (001),  $a$  (100),  $b$  (010),  $m$  (110),  $i$  (021),  $k$  (011),  $p$  (111),  $o$  (112). The drawing suggests Laspeyre's figure of aragonite from Oberstein, only our crystal has more forms, and is drawn in ideal symmetry. The measured agree well with the theoretical angles.

Pl. xx., fig. 3 is a stereographic projection showing all the forms recognised on Magnet cerussite and the principal zones.

## ZIRCON.

### GLEN INNES, NEW SOUTH WALES.

Mr. D. A. Porter has been kind enough to lend me for description some crystals of zircon from Glen Innes and Inverell, both in the New England district of New South Wales. In a paper read before the Royal Society of New South Wales, Mr. Porter gives an exhaustive description of the occurrence of zircon in this district.<sup>12</sup> "In the Inverell District zircons are found in many places over a large area, chiefly of basaltic country, forming the watershed of the Macintyre River on the northern side, and extending from N. to E.S.E. from Inverell. They occur principally in the beds of streams, or scattered over low sloping ridges, and in the beds of clay and boulders, which form raised beaches along the creek sides in many of the localities. . . . The zircons from these several localities mentioned, are usually more or less broken or cleaved, and very much worn and smoothed, but occasionally in fairly perfect crystals, of which figures 1 and 2 are representations." Glen Innes and Inverell are about thirty miles apart and we may take it that the zircon found at both places is similar in origin.

<sup>12</sup> Porter—Journ. Roy. Soc. N. S. Wales, xxii., 1888 (1889), pp. 82-83. pl. 1., figs. 1, 2.

One good, doubly-terminated crystal from Glen Innes (Pl. xx., fig. 4) was measured on the goniometer. It is slightly worn and broken, and very irregularly developed as is usual with zircon, but the reflections are fairly good. The forms present are  $m$  (110),  $p$  (111),  $v$  (221),  $u$  (331) and  $x$  (131), the largest faces belonging to  $m$ ,  $p$  and  $x$ ; the forms  $u$  and  $v$  are small,  $u$  having only two faces present, while  $v$  has but one. The crystals vary from clear, colourless to dark red by transmitted light. The measured and calculated angles are tabulated below.

Form.		Measured.				Calculated.				Error.	
		$\phi$		$\rho$		$\phi$		$\rho$		$\phi$	$\rho$
		o	'	o	'	o	'	o	'	'	'
$m$	110	44	56	90	13	45	9	90	0	4	13
$p$	111	45	1	42	5	45	0	42	9	1	4
$v$	221	45	35	60	54	45	0	61	5	35	11
$u$	331	45	3	69	53	45	0	69	47	3	6
$x$	131	18	18	63	41	18	26	63	43	8	2

Sp. g. 4.64.

#### INVERELL, NEW SOUTH WALES.

Out of a collection from this locality sent me by Mr. Porter only one crystal was sufficiently good for measurement on the goniometer. It is doubly terminated, most irregular in development, and the faces are polished and slightly rounded, giving only blurred reflections. It shows only the forms  $m$  (110),  $p$  (111) and  $x$  (131), of which  $m$  is small (Pl. xx., fig. 5). Sp. g. 4.66.

#### BOAT HARBOUR, NEAR TABLE CAPE, TASMANIA.<sup>13</sup>

I am indebted to Mr. W. F. Petterd for some crystals of zircon from the above locality, as well as for notes on their occurrence. They are not found *in situ*, but as waterworn fragments. Mr. Petterd is of opinion that the mineral is a product of contact metamorphism in granite country. The zircon is accompanied by blue sapphires, menaccanite and other detrital minerals. One fairly well developed, doubly terminated crystal was determined (Pl. xx., fig. 6). The forms present are  $a$  (100),  $m$  (110),  $p$

<sup>13</sup> Petterd—Min. Tasmania, 1893, p. 72.

(111), *v* (221), *u* (331) and *x* (131) of which *a* and *p* predominate. The crystal is dark-red in colour and shows a striated area in one part. All the forms are present with the full complement of faces except *u* which has but two. The crystal measures approximately 10 mm. in diameter. Below are the mean co-ordinate angles obtained. Sp. g. 4·57.

Form.		Measured.				Calculated.				Error.	
		$\phi$		$\rho$		$\phi$		$\rho$		$\phi$	$\rho$
		$^{\circ}$	'	$^{\circ}$	'	$^{\circ}$	'	$^{\circ}$	'	'	'
<i>a</i>	100		2	90	1	0	0	90	0	2	1
<i>m</i>	110	45	0	90	2	45	0	90	0	0	2
<i>p</i>	111	44	59	42	9	45	0	42	9	1	0
<i>v</i>	221	44	56	61	5	45	0	61	5	4	0
<i>u</i>	331	45	2	69	43	45	0	69	47	2	4
<i>x</i>	131	18	26	63	43	18	26	63	43	0	0

I wish to express my obligation to Mr. W. F. Petterd and Mr. D. A. Porter for the loan of specimens and for information freely given; also to Professor T. W. E. David for kindly affording me an opportunity for study in the Geological Department of the University.

NOTE.—While this paper was passing through the press I have learnt that M. A. Lacroix has already described crystals of anglesite from the Mine Meretriche, New Caledonia, in a "Note préliminaire sur les minéraux des mines de la vallée du Diahot (Nouvelle-Calédonie)."<sup>14</sup> The author promises a further description in his *Minéralogie de la France et de ses Colonies*, but I have not been able to refer to the later work.

<sup>14</sup> Lacroix—Soc. Fr. de Min., xvii., 1894, p. 51.

ON A LARGE EXAMPLE OF *MEGALATRACTUS*  
*ARUANUS*, L.

BY CHARLES HEDLEY, Conchologist.

(Plates **xxi.**-**xxii.**, and fig. 24).

Since the appearance of Mr. H. L. Kesteven's article<sup>1</sup> on the structure of *Megalatractus aruanus*, further notes and information have been accumulated on the subject by the writer. The size attained by this gigantic shell does not seem to be generally appreciated. It is quoted by Deshayes<sup>2</sup> as "longueur 3 pouces, 11 lignes." The latest monographer, Tryon,<sup>3</sup> gives the length as from 8-12 inches. It appears to be the largest recent Gasteropod. So far as I am aware, no illustration of the adult shell has appeared.

The Trustees have lately received from Mr. P. G. Black a magnificent specimen which that gentleman procured in Torres Strait, and which is figured on the accompanying plate (Pl. **xxi.**). The subject of this note weighs ten pounds twelve ounces, the breadth is ten and a half inches, and the length one foot ten and three-quarter inches. As usual in the adult state, the apex is decollated; by comparison with younger examples it is estimated that in the individual figured the styliform embryo and two and a half succeeding whorls have been removed, curtailing the total length by three-quarters of an inch. Seven whorls now remain. In the young shells the keel bears projecting nodules, but in the adult it is smooth.

The original figure of this species by Rumphius,<sup>4</sup> upon which Linne founded the species,<sup>5</sup> and from which he derived the name and locality, is reversed. That this was done by error of the engraver and not intentionally is shown by the fact that the remaining figures of *Septa tritonis*, Linn., &c., upon the same plate are also reversed. This unfortunate mistake evidently caused Linne to confound this shell with the American *Fulgur carica*, Gmelin, which is really a sinistral shell.

---

<sup>1</sup> Kesteven—Austr. Mus. Mem., iv., 1904, pp. 419-449.

<sup>2</sup> Deshayes—Anim. s. Vert., 2nd. ed., ix., 1843, p. 450.

<sup>3</sup> Tryon—Man. Conch., iii., 1881, p. 52.

<sup>4</sup> Rumphius—D'Amboinsche Rariteikamer, 1741, p. 93, pl. **xxviii.**, fig. A.

<sup>5</sup> Linnæus—Syst. Nat., 10th. ed., 1758, p. 753.

According to Brauer,<sup>6</sup> the *Murex gigas* of Born is a synonym of this species.

*Buccinum incisum* of Martyn is usually considered to belong here also. The locality he gave has been noted as erroneous by E. A. Smith.<sup>7</sup>

The islanders of Torres Strait employed this shell in their ceremonies. Prof. A. C. Haddon<sup>8</sup> has described and figured its use in the "zogo," or sacred ground of Murray Island. In a drawing by Prof. T. H. Huxley,<sup>9</sup> the species is shown mounted on a funeral screen at Mt. Ernest, Torres Strait.

When visiting Bentinck Island, Gulf of Carpentaria, in June, 1903, as the guest of Dr. W. E. Roth, I gathered a specimen (Pl. xxii.) eighteen inches in length which the aborigines had employed for carrying water. To facilitate transport, a hole had been knocked in the ventral surface at the margin of the inner lip, in which the thumb was inserted while the fingers grasped the columella.

Dr. Roth notes<sup>10</sup> that at Mapoon, Cape York Peninsula, where it is called "pandari," the natives eat the mollusc and manufacture the shell into nose-pins and water-vessels.

I am indebted to Mr. A. Morton for permission to notice here an interesting specimen preserved in the Tasmanian Museum. A shell (fig. 24) about nine inches in length was perforated in the back of the penultimate whorl, and had been used as a trumpet by the Papuans. It was collected on the Fly River, British New Guinea, by the late Rev. James Chalmers.

The furthest point to which I have traced the species to the south-west is Rest Bay, Exmouth Gulf, W.A., where Admiral P. P. King observed<sup>11</sup> "a buccinum of immense size" upon the beach.

On Darnley Island it appears, from an observation by Jukes, to be known as "mabaer."<sup>12</sup>



Fig. 24.

*Megalatractus aruanus*.

<sup>6</sup> Brauer—Sitzb. K. K. Akad. Wiss. Wien, lxxvii., 1, 1878, p. 171.

<sup>7</sup> Smith—Proc. Zool. Soc., 1890, p. 317.

<sup>8</sup> Haddon—Head-Hunters, Black, White, and Brown, 1901, p. 54, pl. vii.

<sup>9</sup> Macgillivray—Voy. "Rattlesnake," ii., 1852, p. 37, pl. ii.

<sup>10</sup> Roth—North Queensland Ethnography, Bull. iii., 1901, p. 18; vii., 1904, p. 3, fig. 203.

<sup>11</sup> King—Survey Coasts Australia, i., 1827, p. 26.

<sup>12</sup> Jukes—Voy. "Fly," i., 1847, p. 189; ii., p. 286.

When alive the shell is entirely covered by a dense buff epidermis, which peels off dry specimens. An example of the animal which I purchased at Mapoon, from an aboriginal who proposed to eat it, served my friend Mr. H. L. Kesteven as a subject for anatomical study.<sup>13</sup>

In previous articles I have discussed the synonymy and egg capsules of the species.<sup>14</sup>

*Add.*—Since the above has been in print the South-western range has been extended by the receipt from Mr. J. M. Sheridan of an egg-case of *M. aruanus*, collected on Carnac Island, seven miles South-west of Fremantle, W.A. The eastern-most record is a dead shell I observed on the beach at Masthead Island, Capricorn Group, Queensland.

---

<sup>13</sup> Kesteven—Austr. Mus. Mem., iv., 8, 1904.

<sup>14</sup> Hedley—Proc. Linn. Soc. N.S. Wales, xxv., 1900, pp. 98 and 508, pl. xxv., f. 18.



## NOTES ON AUSTRALIAN SIPHONAPTERA.

By W. J. RAINBOW, F.L.S., F.E.S., Entomologist.

(Plate xxiii, and figs. 25-29).

Family RHYNCHOPRIONIDÆ.

Genus ECHIDNOPHAGA, Olliff.

Only one species of this genus is known, namely *E. ambulans*, Olliff. This extraordinary flea was obtained from a Porcupine Ant Eater—(*Tachyglossus aculeatus*, Shaw = *Echidna hystrix*). Olliff in his paper "Description of a New Aphanipterous Insect from New South Wales," says that it "was found in large numbers on a Porcupine Ant Eater (*Echidna hystrix*) which was recently added to the collection of the Australian Museum."<sup>1</sup> As a matter of fact I only know of three specimens, and these are in our cabinet. They are probably the only specimens in any collection. Our specimens are mounted on one slide and labelled "*Echidnophaga ambulans*, Olliff, on *Echidna hystrix*, N.S.W. TYPE."

ECHIDNOPHAGA AMBULANS, Olliff.

(Plate xxiii, and figs. 25, 26).

This insect was described by the late Mr. A. S. Olliff in the paper referred to above, but it was not figured. An examination and study of the type specimens reveal the fact that some corrections and amplifications (aided by figures) to the original description are necessary. The description below should therefore be read in conjunction with Olliff's. In this species the body is globose, smooth, free from hairs and bristles except in the region of the genital aperture.

*Antennæ* capitate, three-jointed (not four-jointed as stated by Olliff). *Eyes* prominent. *Caput* convex above. On the dorsal line, the pro-thorax is very short; the meta- and meso-thorax are longer and of equal length to each other.

---

<sup>1</sup> Olliff—Proc. Linn. Soc. N. S. Wales, (2), i., 1886, p. 172.



Fig. 25.

*Echidnophaga ambulans.*

the genital aperture distinct (figs. 25, 26).

*Obs.*—This species has aroused much interest amongst students who have devoted special attention to the Siphonaptra, and it has generally been regarded as “practically unknown.” Some correspondence has recently passed between Mr. Carl Baker and myself in respect of this species, in the course of which I have supplied that gentleman with rough sketches of the type. This with a view to settling the exact systematic position of *E. ambulans*. In acknowledging my communication and sketches Mr. Baker says:—“The sketches were of the utmost service to me for one thing at least. They enabled me to definitely place *Echidnophaga* in its proper family. Its greatly shortened thoracic segments proclaim it of the Rhyncho-prionidæ (Sarcopsyllidæ), unmistakably. It is very near to the common chicken flea (*Argopsylla gallinacea*) and indeed I very much suspect that it may belong to the same genus.”

Family, PULICIDÆ.

Genus CERATOPHYLLUS, Curtis.

Some time ago I published a short paper entitled “Notes on

*Legs.*—Rather long; femora smooth, and furnished with two moderately long apical spines or bristles; each tibia is notched on the upper surface, but this character is not constant in point of number of notches, one of the types having two notches and another three; from each notch two long bristles project; apical extremities broad and furnished with six long bristles; tarsal claws exceedingly long, smooth.

*Abdomen.*—Globose, convex. Of the three type specimens the posterior extremity of the abdomen in two of them is rounded (Pl. xxiii, fig. 1), and the genital aperture is not visible; in the third example the posterior tergite is excavated; and the genital aperture distinct (figs. 25, 26).



Fig. 26.

*Echidnophaga ambulans.*

Fleas Parasitic on the Tiger Cat;<sup>2</sup> in which I pointed out that the form described by Skuse as the male of his *Stephanocircus dasyuri*<sup>3</sup> was referable to another genus, and that in all probability it was *Pulex fuscatus*, Bosc. In arriving at this conclusion I was guided by Carl Baker's "Preliminary Studies in Aphaniptera,"<sup>4</sup> the only work at that time accessible to me. It now appears that the form is distinct from *P. fuscatus*, and that it is a species of the genus *Ceratophyllus*, Curtis. The Hon. N. C. Rothschild, commenting upon this species as described and figured by Skuse remarks: "One of the species, of which Skuse possessed both sexes is probably the one described by us under the name of *Ceratophyllus hilli*."<sup>5</sup> Unfortunately the figure of the *Ceratophyllus* (male) on Skuse's plate is not a good one. The clasper is not defined, and the finger instead of being sickle-shaped stands prominently out like a big tubercle or horn-like process.

*C. hilli* is described and figured by Rothschild in his characteristically thorough manner,<sup>5</sup> and with this work I have carefully compared Skuse's types of his so-called male *Stephanocircus*. The result of this study has convinced me that they are distinct from the male and female of Rothschild's species, *C. hilli*, and as they also appear distinct from other known forms, I herewith append a description, naming the species in honour of the Hon. N. C. Rothschild who has done such admirable work in connection with the *Siphonaptera*.

CERATOPHYLLUS ROTHSCILDI, *sp. nov.*

(Figs. 27, 28, 29.)

♀ *Caput*.—The front of the head bears a row of six fine bristles between the antennal groove and the maxillary palpus; immediately below this there are a number of fine hairs scattered irregularly over the side of the head; again, below the row referred to above, but situated towards the front, there are two pairs of long fine bristles, one pair being below the other; below these again, there is a larger and stronger bristle than the foregoing. The hinder part of the head bears three rows of bristles:

<sup>2</sup> Rainbow—Rec. Austr. Mus., v., 1903, pp. 53-55.

<sup>3</sup> Skuse—Rec. Austr. Mus., ii., 1893, p. 78, pl. xvii.

<sup>4</sup> Rothschild—Ent. Monthly Mag., (2), xvi., 1905, p. 60.

<sup>5</sup> Rothschild—Novit. Zool., xi. 1904, pp. 622-3, pl. xi., figs. 43, 44

the sub-apical row extending from the antennal groove to the vertex, is oblique, and is composed of six, of which the first four are of equal length or nearly so, and the other two distinctly smaller, the sixth being shorter than the fifth; in the second row there are five bristles, of which the first two are very long, the third somewhat shorter, and the fourth and fifth much smaller still; the third row fringes the basal angle of the head, and consists of five: the bristle nearest the antennal groove is not only the longest of the series, but is widely separated from its nearest neighbour; of the others constituting the third or posterior row, the three median bristles are of equal length, or nearly so, and the fifth is much the smallest; below the antennal groove, and immediately before the first of the basal row of bristles, there is an irregular group of short, stiff hairs or bristles, and again between the first and second bristles, a row of three short,



Fig. 27.  
*Ceratophyllus*  
*rothschildi*.

fine hairs. In front of the antennal groove there are two long bristles placed one beneath the other, though somewhat widely apart. The first row of six fine bristles in front of the head is divided into two series of three each by the interception of two short but exceedingly robust horn-like bristles, of which the anterior one is not only much the longest, but gently curved (fig. 3). The second segment of the maxillary palpus is longer than the fourth, and the rostrum reaches beyond the end of the fore coxa. Apical extremities of the first and second joints of the antennæ are fringed with a row of short stiff black hairs or bristles.

*Thorax*.—The pro-notum has a comb of about 18 teeth, and two rows of bristles, those of the posterior row being much the longest, widely separated from each other individually, and overlapping the comb; there are also a number of short fine hairs scattered over the surface. The meso-notum has three recurved rows of bristles and a few fine, scattered hairs; the bristles constituting the posterior row are much the longest, and those of the anterior row much the shortest; the meso-thoracical epimerum has two vertical though somewhat oblique rows of two bristles each, and beyond these one single bristle, all of which are very long; besides these there are a few shorter ones present. The meta-notum is also provided with a few scattered fine hairs, and three rows of bristles similar to those on the meso-notum; the meta-thoracical epimerum has two pairs of long and a few short, fine bristles.

*Abdomen.*—The first abdominal tergite bears three rows of bristles and a few short hairs in front; the bristles constituting the posterior row are very long, those of the median row are individually about one-half the length of their posterior neighbours, and double the length of those of the anterior row. Tergites 2 to 4 have each one row of extremely long bristles, and another in which each individual is about one-half the length of the latter; each of these tergites has, in addition, a few fine hairs. Tergite 5 has only one row of bristles (each individual of which is very long) and a few short hairs, whilst tergite 6 has three slightly recurved rows, the first of which consists of four very short bristles, the second, ten, about twice the length of the latter, and the posterior row, twelve exceedingly long bristles. Tergite 7 has three rows of four, six, and eight respectively, and a few fine hairs; there are also two pairs of long and heavy bristles seated at the apex, and of these each outer one is longer than its inner neighbour. The posterior tergite has four short heavy bristles, and a number of long and short fine hairs. On sternite 1, there is one long bristle on each side, and no lateral ones, whilst in respect of the others there is on each a ventral patch of bristles, of which the posterior ones are much the longest and strongest. Pygidium much deeper than wide, and clothed with long coarse bristles and fine hairs (fig. 28).



Fig. 28.  
*Ceratophyllus rothschildi*.

*Legs.*—Long. Fore coxa furnished with long strong bristles and short, fine hairs. Median coxa smooth on the upper angle and outer side; lower angle clothed in its entire length with short hairs or bristles which are exceedingly fine at the base, but become gradually stronger towards the apex, which is completely encircled by them. The hind coxa is also smooth on the upper angle; the outer side is smooth at the base, and for about one-half its length, from whence it is moderately hairy, and provided with bristles which become gradually stronger towards the apex; lower angle clothed with short fine hairs at the base, but becoming gradually stronger towards the apex which is encircled with fine hairs and coarse bristles. The fore femur has a number of shorter and longer fine hairs scattered over its outer surface, and one very long bristle on its inner angle near the apex. The median femur

has the inner angle furnished with short stiff hairs, and the outer side smooth, except at the apex where there are three moderately long bristles; lower angle smooth also, except at apex where there are two moderately long bristles, and a few short fine hairs. Posterior femur has its inner angle similarly clothed to the foregoing, but its lateral apical extremity is furnished with six moderately strong bristles; outer angle smooth. The fore tibia has six notches on its upper angle, from each of which a pair of stout bristles proceeds, the upper one of each pair being the longest; in addition to these there are on the outer side, and near the notched angle, two rows of strong hairs, the lower ones being somewhat the longest; lower angle smooth, but furnished at the apex, on the outer angle, with a pair of stout bristles. Median tibia has also six notches on its upper angle, and is similarly clothed with bristles and hairs to the foregoing; the outer side is also similar to that of the fore tibia, but its lower angle is clothed with fine hairs; apex as in fore tibia. The posterior tibia has seven notches on its upper angle, from each of which a pair of stout spines proceeds; of these the first pair is very short, otherwise the clothing and armature are similar to the median tibia. Of the first and second tarsi, the fourth joint is much the shortest, and the fifth the longest; all the joints are clothed with fine hairs and a few stout bristles; the fifth joint of the first and second tarsi have each four pairs of bristles on the under side. Of the posterior tarsi, the first joint is much the longest, and the fourth much the shortest; the second joint is longer than the third, and the latter rather longer than the fifth; all the joints of the posterior tarsi bear a number of lateral bristles, between which there is, both on the upper and under sides, two rows of stiff hairs.

♂ *Caput*.—The front bears a row of seven fine bristles between the antennal groove and the maxillary palpus; below this there are a number of smaller hairs scattered over the side of the head. Again, below this row there are two long bristles, and further down two more placed closely together. The subapical row forms a complete series, being, unlike that of the female, not interrupted by short, horn-like bristles. The hinder part of the head bears two oblique rows of bristles, those of the second row being much the longer; below the latter row there is another series of bristles, which form an uneven row and follow the posterior angle of the head. Rostrum rather shorter than that of the female.

*Thorax*.—Similar to female.

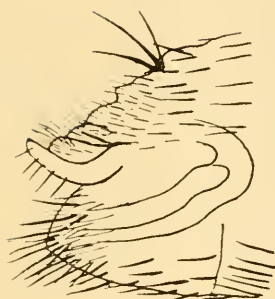

Fig. 29.

*Ceratophyllus rothschildi*.

*Abdomen*.—Similar in vestiture to female. In the modified segments the clasper is produced into rather a long process, bearing one long bristle, and a few short hairs scattered over the sides. The finger is scythe-shaped, moderately long, pointed at apex, and furnished with a few moderately stiff bristles and short fine hairs. Sternite 9 broad, not divided ventrally, and having the apex densely clothed with long fine hairs, and long stout bristles. Spiral of penis consists of two coils (fig. 29).

*Legs*.—Similar to female.

*Hab*.—New South Wales. Host, *Dasyurus maculatus*, Kerr. I have also collected this species from the body of a tiger, *Felis tigris*, Linn., which died in the Zoological Gardens, Sydney.

#### Family CTENOPSYLLIDÆ.

##### Genus STEPHANOCIRCUS, Skuse.

It is interesting to note that although up to 1903, three additional species of *Stephanocircus* had been described by the Hon. N. C. Rothschild, all, including Skuse's species, were only known to us by female examples. Rothschild has, however, further extended our knowledge of the species constituting the genus, and has during the present year described not only the male of *S. dasyuri*, Skuse, but also the male and female of *S. simsoni*, Roths.<sup>6</sup>

All Rothschild's material was obtained from Launceston, Tasmania, the hosts being for *S. dasyuri*: *Mus velutinus*, Thomas, a Tasmanian Native Rat; *Peremeles gunni*, Gray, Striped Bandicoot; and *Dasyurus maculatus*, Kerr, Tiger Cat. *S. simsoni* was obtained from *M. velutinus* and *D. maculatus*.

We thus now know of five species of this interesting genus, namely:—

*S. dasyuri*, Skuse—Rec. Austr. Mus., ii., 1893, p. 78, pl. xvii., figs. 2, 2a, 2b, 2c, 2d, 2e.

„ Baker—Canadian Entomologist, xxvii., 1896, p. 63.

<sup>6</sup> Rothschild—Ent. Monthly Mag., xvi., 1905, pp. 61-62, pl. i.

- S. dasyuri*, Skuse—Rec. Austr. Mus., ii., 1896, p. 110.  
 ,, Rainbow—Rec. Austr. Mus., v., 1903, pp. 53-55.  
 ,, Baker—Proc. U. S. Nat. Mus., xxvii., 1904,  
 pp. 430-431.  
 ,, Rothschild—Ent. Monthly Mag., xvi., 1905,  
 pp. 60-61, pl. 1., figs. 1, 4.

*Hab.*—New South Wales, and Launceston, Tasmania.

- S. mars*, Rothschild—Novit. Zool., v., 1898, p. 544,  
 pl. xvi., fig. 11.  
 ,, Baker—Proc. U. S. Nat. Mus., xxvii., 1904  
 p. 431.

*Hab.*—Argentina.

- S. thomasi*, Rothschild—Novit. Zool., x., 1903, pp. 318-319,  
 pl. ix., figs. 4, 5.

*Hab.*—Barrow Island, N. W. Australia. Host—*Mus. ferculinus*,  
 Thomas.

- S. minerva*, Rothschild—*Loc. cit.*, p. 319, pl. xi., figs. 6, 7.

*Hab.*—Paraguay (near Sapucay).

- S. simsoni*, Rothschild—Ent. Monthly Mag., xvi., 1905,  
 pp. 61-62, figs. 2, 3.

*Hab.*—Launceston, Tasmania.

In his generic diagnosis, Skuse says:—"Antennæ capitate, four-jointed."<sup>7</sup> In respect of this Baker remarks: "The matter of four-jointed antennæ must certainly be re-examined. If such a character is presented, then this species must be made the type of a new family differing from all other fleas. But in the description of the apparently congeneric *Stephanocircus mars*, Rothschild says nothing about four-jointed antennæ, and his drawing does not show four joints."<sup>8</sup> The point raised is an important one, and a careful examination of the types discloses the fact that the antennæ are normal—*three-jointed*.

<sup>7</sup> Skuse—Rec. Austr. Mus., ii., 1893, p. 78.

<sup>8</sup> Baker—Proc. U. S. Nat. Mus., xxvii., 1904, p. 431.



*Genus* CTENOPSYLLUS, Kol.

Among some fleas forwarded to Mr. Carl Baker, of which duplicates are in the Museum collection, there were specimens of *C. musculi*, Duges. These were from Brisbane and Dunedin—localities which constitute a new record for this species; indeed, according to Mr. Baker, who has made a specialty of the Siphonaptera, this is the first recorded appearance of this species in Australia. They were collected from rats.

## THE OSTEOLOGY OF THE NEW GUINEA TURTLE

(*CARETTOCHELYS INSCULPTA*, Ramsay).

By EDGAR R. WAITE, F.L.S., Zoologist.

(Plates xxiv.-xxvii., and figs. 30-32).

Since first described by Dr. E. P. Ramsay in 1886,<sup>1</sup> the New Guinea turtle, *Carettochelys insculpta*, has excited considerable interest and provoked much speculation as to its systematic position.

Hitherto the species, which as far as ascertained is the sole living representative of the genus and family, was known only from the type and two imperfect skulls; the latter described by Dr. G. A. Boulenger as ornaments or charms attached to a dancing stick, from the Fly River, British New Guinea.<sup>2</sup>

In the account of the original specimen no mention is made of the manner in which it was procured. As the history of such an example will be of interest, I venture to publish the following particulars from information kindly supplied by Mr. Walter W. Froggatt, F.L.S., Government Entomologist for New South Wales:—

“The fresh-water turtle described by Ramsay was one of two specimens obtained in the Strickland River (the upper right hand branch of the Fly River), in the Geographical Society of Australasia's Expedition to New Guinea in 1885. Captain Hy. C. Everill was in charge, and I was Entomologist and Assistant Zoologist, etc. There were large sand banks all along, but we saw no signs of these turtles in the lower parts of the river. Six of us took the whale boat up the last hundred miles after the ‘Bonito’ stuck in the gravel, and as we towed the boat along the two turtles ran off the sand banks into shallow water and were caught. We ate the contents of both: a large number of eggs were found inside them. It was evidently breeding time as some of the sand banks were covered with their tracks: though we hunted round at several camps we could not find any buried eggs. This was about the middle of October, 1885. Jas. H. Shaw and I caught the type one evening, and I skinned and cleaned it.”

---

<sup>1</sup> Ramsay—Proc. Linn. Soc. N. S. Wales, (2), i., 1886, pp. 158-162, pls. iii.-vi.

<sup>2</sup> Boulenger—Proc. Zool. Soc., 1898, p. 851.

Portions of another example of *Carettochelys*, of unknown sex, just received by the Trustees, enable me to supplement the published accounts of its structure and also to correct errors in previous descriptions.

The material consists of the head, with four cervical vertebrae attached, in spirits, and the carapace and plastron. The turtle was taken at the island of Kiwai (Kewai) at the mouth of the Fly River. It was caught at night with hook and line by natives, and the portions not eaten or broken were obtained, and kindly forwarded by the Rev. E. B. Riley. Captain Arthur J. Wyrill of the London Missionary Society's S.S. "John Williams," obligingly brought the salvage to Sydney.

The following is a description of the portions examined:—

*Head.*—The anterior portion of the head is in perfect condition, but the hinder part above, and the hyoids had been removed. The snout is perhaps the most remarkable feature of the head, it is much more prominent than would be inferred from the published figures of the type which was probably dried before an examination had been made. The snout is a fleshy organ, its front and lateral aspects covered with tubercles and freely furrowed; it is much bent downwards and is produced considerably beyond the margin of the jaw. Its front edge is truncated, pig-like, being very deep and blunt: the wide nostrils are situated in its upper portion;

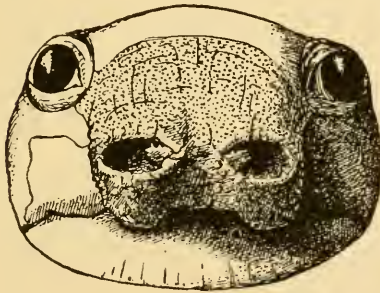

Fig. 30.

their relative position is shown in the accompanying sketch (fig. 30), five-sixths natural size. A valve-like process is developed within the nostril on the inner side. In the preserved example no trace of sutures is visible in the large head shields, and those described by Ramsay are, as indicated by Dr. G. Baur, simply impressions of the bony sutures of the skull, to which the skin has moulded

itself in drying. The rugosities of the surface which also merely repeat the inequalities of the skull are not so pronounced in the preserved as in the dried example.

☞ *Skull.*—The skull is moderately arched and of even contour. The orbits are subcircular, large, lateral, and widely separated:

each is encircled by five bones, namely the maxillary, prefrontal, frontal, postfrontal, and jugal. The bony external nostril is very large, wider than deep, and is bounded by the single premaxillary, the maxillaries and prefrontals. The orbital margin of the postfrontal is greater than that of the prefrontal, that of the frontal being smallest of the three. The suture between the postfrontal and parietal is shorter than that between the postfrontal and frontal. The parietals, though laterally expanded, do not roof over the temporal regions, the fossæ extending forward to the postfrontals: the latter bones are separated from the squamosals by the quadrato-jugal. The maxillary is sutured with the quadrato-jugal below the jugal. The quadrate forms a complete frame to the tympanum, the deep quadrato-jugal and squamosal just failing to meet above. The quadrate is not completely closed behind, and the posterior notch, though wide, is not deeply cleft; its lower surface bears two articular facets. The supraoccipital process is extensive and its inferior margin is laterally expanded forming a spoon-shaped plate whose width exceeds the greatest depth of the crest. The foramen magnum is an even oval, deeper than broad and is bounded by the supraoccipital and the exoccipitals. The elements are not apparent in the occipital condyle. The vomer is small and if naturally connected with the premaxillary, the slender process has been broken away. The prefrontals are connected with the vomer and palatines by a broad thin process developed from the prefrontals, the sutures being close to the vomer and not to the roof of the snout; the lateral view through both orbits is thus, not as usual, but mainly through the palato-maxillary foramina. The palatines are large, separated in front by the small V-shaped vomer, but extensively in contact on the mid-line. The basisphenoid is large, widest behind where it is in contact with the basioccipital; these bones are evenly sutured, the first-named not forming a shelf below the latter. The pterygoids are long and narrow, in contact, in front, with the maxillaries: they are wholly separated by the basisphenoid and are produced backwards to form the outer boundaries of the basioccipitals. At the side of the basisphenoid each pterygoid develops a lateral process which is separated from the quadrate by a deep groove. The connection between the parietals and pterygoids is carried forward, below to the palatines, and above, to the suture between the prefrontals and frontals. The lamellæ thus formed broaden laterally in front and meet on the mid-line, and they run so close to the prefronto-palatine connection, before described, that it is not possible to pass an object as thin as a penknife blade, through the orbits, between them.

The mandible has the elements distinct but no symphyseal suture is apparent in the adult; the coronoid and postarticular processes are well developed. The hyoids were removed by the natives and not recovered. Baur described the supraoccipital process as "club-shaped," this scarcely conveys an idea of the true form but it will doubtless be understood that the outline as seen from above or below only is intended; the whole process being formed of two lamellæ at right angles to each other, a vertical crest and a basal lateral expansion. The question raised by this writer as to whether the pterygoids are completely separated by the basisphenoid or not, is now answered in the affirmative. Baur also remarks that in the type the frontals are excluded from the orbits, I am not aware how this information was obtained, but in the specimen under examination, as above described and as also shown in the photograph (pl. xxvi.), the frontal forms a portion of the orbital boundary, though the smallest of any bone so doing. Another point raised is the condition of the premaxillary, this has already been determined by Boulenger to be a single bone, and he also found that "the pterygoids are not turned up in front."

*Vertebrae.*—The CERVICAL vertebræ are comparatively short and do not possess transverse processes. Though but five of the eight presumed cervical vertebræ were preserved, it would seem that the neck is shorter than the combined dorsal vertebræ.

The first vertebra (axis) is biconcave and has all the elements united into a single bone, the postzygapophyses are long and widely spread.

The second vertebra (atlas) is convexo-concave and has the spinous process well developed.

The third vertebra is also convexo-concave and, as usual, has no spinous process.

The fourth vertebra, the character of which has an important bearing on the classification of the order, has most unfortunately had the posterior portion cut away, anteriorly its articulation is convex.

The three following vertebræ are absent, but the last cervical, which may be presumed to be the eighth, is doubly biconvex so that the articulation between the seventh and eighth cervicals and the latter and the first dorsal is of the ginglymoid type. The posterior articular surface of the eighth vertebra extends along the whole length of the curved portion and the dipping action is thus very considerable. The usual forwardly directed ventral keel is, in this species, replaced by a pair of conical pro-

cesses. The general form of the eighth vertebra will be best comprehended by reference to the figures depicting the lateral and ventral aspects (Pl. xxvii., figs. 4a, 4c).

The DORSAL vertebrae are ten in number. The first is shorter than the second and has a depressed centrum with two concave articular surfaces in front, it bears a short rib connected with the second rib. The ventral aspect of this vertebra together with portion of the carapace to which it is attached is shown in Pl. xxvii., fig. 5c.

The second to the seventh vertebrae, inclusive, are long and strongly compressed but do not form a distinct ventral keel.

The eighth is rounded below, and the ninth bears on its anterior ventral surface a deep pit nearly as wide as the centrum itself.

The tenth vertebra is short with a posterior condyle, the tenth rib is connected directly with the carapace and does not abut on to the preceding rib.

The following free vertebrae are absent, but the nature of the parts remaining shows definitely that the pelvis is not ankylosed to the carapace and plastron. Dr. Hans Gadow<sup>3</sup> writes as though the pelvis was known: "the skeleton, notably the plastron, pelvis, and skull, conform with the *Pleurodirous* type."

*Carapace.*—The carapace measures 430 mm. in length and 330 mm. in breadth. During, probably, immature life, it received an injury, having apparently been crushed between the right anterior and left posterior aspects, resulting is distortion of the former and breaking of the latter, one of the marginal plates also being cracked: these defects will be seen in Pl. xxiv. and fig. 32.

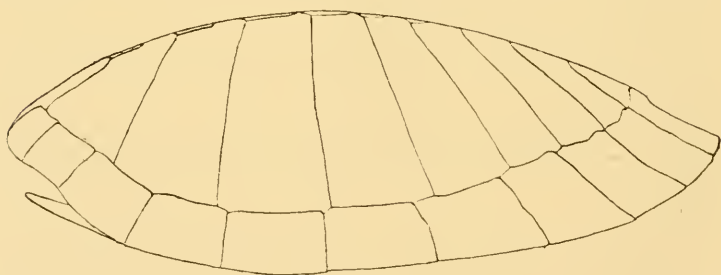

Fig. 31.

The posterior dorsal keel is extremely marked, much more so than in the type: the relative contours are illustrated in the

<sup>3</sup> Gadow—Cambridge Nat. Hist., viii., Reptiles, 1901, p. 404.

accompanying diagrams, fig. 31 representing the type and fig. 32 the specimen now described, which is smaller and possibly younger than the former.

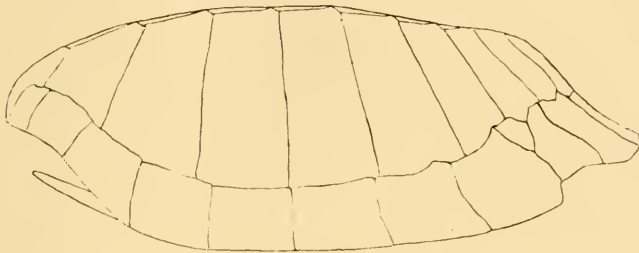

Fig. 32.

The neural plates are seven in number, but as the posterior one is very small it may be that in earlier life an eighth even may be developed and afterwards lost by encroachment of the costals. The relative larger size and greater number of neurals in the younger specimen suggests that a median growth of the costals takes place with age; for they are entirely separated by the fifth, sixth, and seventh neurals, and the sutures between the anterior pairs of costals is not more than 3 mm., while in the type all the costals meet in the mid line and the sutures referred to nearly equal the length of the respective neurals. The anterior marginals, of which there are ten pairs, are separated by the large nuchal, and the posterior pair by the single pygo-marginal.

The absence of epidermal shields is well illustrated in the accompanying photographs, where the dark lines on the inner side of the carapace (Pl. xxiv.) will be seen to be coincident with the sutures indicated on the dorsal surface.

*Plastron.*—The plastron was originally described as formed of nine shields, but Ramsay remarked:—"There are two small portions cut away from between the second and third plates and the marginals, so that it is impossible to say if these are extra plates or parts of the marginals." . . . They "are probably only the curved-in portions of the adjacent marginals." Respecting the carapace and plastron Baur wrote:—"Both have been figured by Ramsay, but there was some doubt about the presence or absence of a mesoplastral element. . . . The most interesting new point to be noted in the plastron is the presence of a small distinct mesoplastral element. The structure of the plastron is best seen from the figure."

With the actual specimen in hand Ramsay was unable to decide this point, and yet from the inspection of a photograph only, Baur definitely pronounced on the presence of a mesoplastron. His conclusions are quite wrong, there is no such plate; an incurvation of the marginal being responsible for the appearance in the illustration. My photograph, published on Pl. xxiv., fig. 2, very clearly shows the exact condition. I may mention that the carapace and plastron have not been separated, and are illustrated in natural connection. The sutures also have not been artificially emphasised.

*Dimensions* :—

Carapace—length	...	...	430	mm.
„ breadth	...	...	330	„
Plastron—length	...	...	320	„
„ breadth	...	...	272	„
Skull— length	...	...	123	„
„ „ basal	...	...	93.6	„
„ width	...	...	75.0	„
„ „ interorbital	...	...	34.7	„
1st Vertebra, length of centrum	...	...	14.3	„
2nd „ „	...	...	27.2	„
3rd „ „	...	...	29.2	„
8th „ „	...	...	10.5	„
1st Vertebra, width outside				
posterior zygapophyses...			27.9	„
2nd „ „ „	...	...	23.6	„
3rd „ „ „	...	...	26.1	„
8th „ „ „	...	...	26.0	„
Dorsal Vertebrae <i>in situ</i>	...	...	278.0	„

In reading the proofs Dr. Ramsay overlooked some vagaries of the printer. The genus is rendered as *Carettochelys*, but associated with the species it reads *Carettochelys*, while on the only other occasion on which the word is used it appears as *Carrettochelys*.

The author of the species referred it to the family Trionychidæ and suggested that it formed a link between the river tortoises and the sea turtles. In raising the genus to family rank Boulenger assumed that it was a Pleurodiran because, all then known Papuanian and Australian Chelonians belonged to that division. Characters of the neural bones, and plates on the fore limbs were also considered to point in that direction. Baur thoroughly reviewed the situation and rejected the Pleurodiran nature of the genus. He considered that the Carettochelydidaë, to which he assigned both *Pseudotrionyx* and *Carettochelys* “came from a group of tortoises related to the stock from which



Staurotypidæ and Cinosternidæ developed." He also thought it "probable that the *Carettochelyidæ* are very close to the ancestors of the *Trionychia*, of which they are only survivals." When examining the two imperfect skulls, previously referred to, Boulenger found characters possessed only by *Chelys*, among the *Pleurodira* and by the *Trionychidæ*.

From the *Pleurodira* it is definitely excluded by the following characters :—

The neck is bent in a vertical and not in a lateral plane ; the cervical vertebræ do not possess transverse processes, and the articulation between the centra of some of the posterior vertebræ is ginglymoid. The pelvis is not ankylosed to the carapace and plastron.

Vaillant placed *Carettochelys* next to the *Dermatemydidæ* in the sub-tribe *Phaneroderinea* of the *Euchelonina*.

*Carettochelys* has considerable affinity with the *Cryptodira* as defined by Boulenger ; especially, as pointed out by Baur, with the families *Dermatemydidæ*, *Staurotypidæ*, and *Kinosternidæ*. The difference as regards deep-seated characters may be expressed as that of the condition of the pterygoid bones. In *Carettochelys* they are widely separated by the palatines, basisphenoid and basioccipital. In the *cryptodiran* chelonians, the pterygoids are in contact on the mid-line. The cervico-dorsal articulation is *cryptodiran*, being, as I have shown, between the centra of the vertebræ, and not between the *zygapophysys* alone, as in the *Trionychoidea*. On the other hand, the character of the pterygoids and premaxillary associates *Carettochelys* with the latter division.

It would seem therefore that, fundamentally, the *Cryptodirans* and the *Trionychoideans* are related through *Carettochelys* and its fossil allies, and that the two divisions should not be separated, in a linear arrangement, by the *Pleurodirans*. The features of this reptile thus support the classification adopted in recent revisions. Want of an acquaintance with fossil forms, the absence of specimens for comparison and the necessary literature, compel me to abstain from a discussion of this subject. I trust, however, that those who are qualified to weigh the facts adduced, will find the *data* and illustrations supplied, useful in the elucidation of an interesting problem.

The whole characters of this Chelonian are not yet, by any means, perfectly known, and further material will be necessary before the fourth and three succeeding vertebræ, the pelvis, and caudal vertebræ can be described. We know nothing of the shoulder-girdle and limb bones, and the number of phalanges in the digits is still an uncertain quantity.

A few other points remain to be dealt with. Up to 1903 all the Chelonians recorded from New Guinea were Pleurodirans. In that year, however, I announced the occurrence of *Pelochelys cantoris*, Gray, in New Guinea,<sup>4</sup> and thus added a member of the Trionychoidea to the known fauna.

Ramsay remarked that the head was non-retractile, a statement doubted by Baur, and as I have shown incorrect.

In comparing *Carettochelys* with *Pseudotrionyx*, an affinity suggested by Boulenger, Baur noted the difference in the number of the neural plates, six in the former, seven in the latter. Our example, however, shows an agreement in this respect between the two genera. The characters of the family as defined by this writer require emendation, the plastron in *Carettochelys* being composed of nine elements only, the supposed mesoplastra being absent.

This turtle was originally described as an inhabitant of fresh water, but the occurrence of an example at the island of Kiwai shows that it is also an estuarine form. The main outlet of the Fly River is twelve miles across, and Kiwai is a large island in the river about eight miles from the mouth. It supports two villages separated by a salt-water creek, but connected by a native bridge. Mr. Froggatt tells me that at Kiwai the water is absolutely salt, so that the turtle may not be confined to the Fly River or its tributaries, but occur also in other rivers entering the Papuan Gulf.

The following references may be added to the bibliography of the subject, since its publication in the paper first-named below.

Baur, G.—On the relations of *Carettochelys*, Ramsay. *Amer. Nat.*, xxv., 1891, pp. 631-639, pl. xiv.-xvi. and *Science*, xvii., 1891, p. 190.

Vaillant, L.—Essai sur la Classification générale des chéloniens. *Ann. Sci. Nat.*, (7), xvi., 1894, pp. 331-345.

Boulenger, G. A.—Remarks on two imperfect skulls of *Carettochelys insculpta*. *Proc. Zool. Soc.*, 1898, p. 851.

---

<sup>4</sup> Waite—*Rec. Aust. Mus.*, v., 1903, p. 50.

## OCCASIONAL NOTES.

—:0:—

### III. WESTERN AUSTRALIAN PRAWNS AND SPONGES.

In the report of the Fishing Industry for Western Australia, referred to by Mr. Edgar R. Waite, Mr. Gale writes:—"I am pleased to be able to report that prawns in fairly large quantities were caught in this locality. The species discovered, *Euphausia pellucida*, are very large, some measuring as much as nine and three quarter inches from head to tail, and from a gastronomic standpoint are very excellent. They appear to exist in quantities over a large area of ground, and I am firmly of opinion that a new industry will eventually be established in these waters."

A single large prawn was included in the collection forwarded, and this I identify with *Penaeus semisulcatus*, De Haan. As this attains considerable size it is probable that the large prawns mentioned are of this species.

It is extremely improbable that they are correctly associated with the Schizopod *Euphausia*; *E. pellucida*, Dana, being fully adult at 15 mm. (=  $\frac{1}{2}$  inch).

The sponges obtained by the expedition are as follows, all except one being of commercial value:—

*Euspongia illawarra*, Whitelegge.

Four examples of this valuable sponge were collected. Three (Nos. 3, 4, 6) from the beach at Shark Bay and one specimen washed ashore alive at Esperance.

*Hippospongia equina*, Schmidt, var. *elastica*, Lendenfeld, is represented by three examples (Nos. 2, 8, 13).

No. 2 is a beach-worn specimen. No. 8 was washed ashore at Shark Bay; the size of this particular specimen is remarkable, it is stated to have been eight feet long, and three feet by one foot. No. 13 was obtained alive at Fremantle. This variety is identical with the sponge imported from Europe and usually sold by the chemists and druggists in Sydney. The majority of Australian specimens are much coarser in texture and not quite so tough as

the imported article. This may be due to many causes such as higher temperature, food supply, or strong currents. The American and West Indian sponges although identical with the Mediterranean variety are inferior, the texture being more open and somewhat wanting in toughness.

*Hippospongia equina*, var. *meandriniformis*, Hyatt. (No. 5).

This variety is rather coarse in general appearance, the fibres are fine but distant from each other; they are, however, exceedingly tough and elastic, two qualities which render this form of great commercial value. The specimen was obtained at Shark Bay.

*Hippospongia*, sp. (No. 12).

This was obtained alive at Fremantle. It is possibly a form of *H. canaliculata*, Lendenfeld, but it differs greatly from specimens in the Australian Museum, the texture is much finer and the surface is villose. This appearance may be due to the fact that the West Australian example has been macerated, whilst the Museum specimens have been dried in the fleshy condition.

*Thorecta meandrina*, Lendenfeld, is probably No. 7 and is of no commercial value. Shark Bay, W.A.

THOMAS WHITELEGGE.





12351

RECORDS

OF THE

AUSTRALIAN MUSEUM.

EDITED BY THE CURATOR.

---

Vol. VI., No. 3.

---

PRINTED BY ORDER OF THE TRUSTEES.

R. ETHERIDGE, JUNR., J.P.,

Curator.

SYDNEY, JUNE 19, 1906.

## CONTENTS.

	PAGE.
On Two Early Australian Ornithologists. By Alfred J. North, C.M.Z.S., Ornithologist	121
The Cranial Buckler of a Dipnoan Fish, from the Devonian Beds of the Murrumbidgee River, N.S.W. By R. Etheridge, Junr., Curator	129
Mineralogical Notes: No. 3.—Axinite, Petterdite, Crocoite, and Datolite. By C. Anderson, M.A., B.Sc., Mineralogist	133
A Synopsis of Australian Acarina. By W. J. Rainbow, F.L.S., F.E.S., Entomologist	145
Description of and Notes on some Australian and Tasmanian Fishes. By Edgar R. Waite, F.L.S., Zoologist	194
Mollusca from Three Hundred Fathoms, off Sydney. By C. H. Hedley, Conchologist, and W. F. Petterd	211
Studies in Australian Sharks, No. 3. By Edgar R. Waite, F.L.S., Zoologist	226
On a Variety of <i>Goura coronata</i> . By Alfred J. North, C.M.Z.S., Ornithologist	230
Occasional Notes— IV.—Crustacea new to Australia. By Allan R. McCulloch	231



## ON TWO EARLY AUSTRALIAN ORNITHOLOGISTS.

By ALFRED J. NORTH, C.M.Z.S., Ornithologist.

(Plate xxvii.).

### JOHN WILLIAM LEWIN.

John William Lewin was the author of the first work published on Australian Birds. He arrived in New South Wales in 1798 by H.M.S. "Buffalo," and is thus referred to by the Duke of Portland in a communication to Governor Hunter, under date 6th February, 1798. "Mr. Lewin is a painter and drawer in natural history, and being desirous of pursuing his studies in a country which cannot fail to improve that branch of knowledge, you will allow him the usual Government rations during his residence in the settlement."<sup>1</sup> In 1801 Lewin accompanied Lieutenant-Colonel Paterson, the Lieutenant-Governor of the Colony, and others in an exploring expedition up the Hunter and Paterson Rivers, the latter previous to the visit being known as Cedar Arm Surgeon Harris, writing from the Hunter River on 25th June 1801, to Governor King remarks: "The Colonel says he has found several new plants here, and Mr. Lewin also says he has met with new birds. If so, they are above my comprehension, as I see nothing new about them, one hawk excepted, and that only in colour being red with a white head."<sup>2</sup>

In the same vessel which conveyed most of the party during these explorations, the "Lady Nelson," a brig of six guns, Lieutenant Murray, R.N., in February of the following year, discovered and entered Port Phillip.

Probably Lewin obtained the specimens from which his descriptions and figures of the "Scarlet-back Warbler" were taken, during his exploration of these rivers, for in the 1822 edition of his work it is stated that this species "inhabits forests near the banks of Patterson's River." Dr. R. B. Sharpe refers this figure to the Northern and North-western Australian species *Malurus cruentatus*, Gould, but it is unquestionably applicable to the New

---

<sup>1</sup> Bladen—Hist. Rec. N. S. Wales, iii., 1895, p. 358.

<sup>2</sup> Bladen—*Loc. cit.*, p. 417.

South Wales' bird, as is shown by Lewin's remarks. In 1808 Lewin's "Birds of New Holland" was published, the plates being engraved and coloured by the author in the Colony. With the exceptions of the plates in Lewin's "Insects of New South Wales," published by the same author in 1805, these plates were the earliest engravings produced in Australia.

Lewin referred to this edition of his work as "The Birds of New South Wales," and not "The Birds of New Holland," the latter a title it must have received in London, where the letterpress was printed. In *The Sydney Gazette*, of Sunday, November 20, 1808, is the following advertisement:—

"Mr. J. Lewin begs leave to acquaint the Officers, Civil and Military, and their Ladies who honoured with their Names the List of Subscribers to his intended Work, entitled 'The Birds of New South Wales with their Natural History,' that he has received advices promising the Transmittal, by the next arrival, of the Copies of the first volume subscribed for here.

This work, which Mr. Lewin has for many years laboured to render as perfect as he was able, will comprise several Volumes painted, engraved and described from the birds as soon as taken. Each Volume will contain Eighteen Plates with one or more birds on each Plate; many of which are new, beautiful, and some of new genera.

The copies, which will be elegantly printed on an Imperial Quarto, will be delivered as soon as they are received, with every respectful Acknowledgement to those who were kind enough to patronise his exertions in the Colony.

No. 44 Chapel Row."

Four years later, in *The Sydney Gazette*, of Saturday, August 1, 1812, is the following:—

"A CARD.

Mr. J. W. Lewin, begs leave to inform his friends and the Public in general, that he intends opening an Academy for Painting on the Days of Monday, Wednesday and Friday, from the hours of 10 to 12 in the Forenoon."

In the National Art Gallery, Sydney, there is a water-colour by Lewin, entitled "Sydney in 1808." On the 25th April, 1815, Lewin, as painter and naturalist, accompanied Governor Macquarie on his tour over the Blue Mountains.<sup>3</sup> In the Appendix to Wentworth's "Description of the Colony of New South Wales"<sup>4</sup>

<sup>3</sup> O'Hara—Hist. N. S. Wales, 1818, p. 440.

<sup>4</sup> Wentworth—p. 437, 1819.

is a List of Civil Establishments and Public Institutions in the Territory of New South Wales and its Dependencies. Among the Committee of the Police Fund of the Police Establishment at Sydney, the name of Mr. Lewin appears as Coroner.

Lewin died in 1819, and was buried in the Devonshire Street Cemetery, his remains, with others buried there, being transferred a few years ago to the northern shore of Botany Bay, to make room for the new metropolitan railway station at Redfern. The inscription on Lewin's tomb in this cemetery, which is mid-way between Botany and La Perouse, is as follows :—

“ Here Rests  
the Body of J. W. LEWIN, Esq.  
Coroner  
who departed this Life  
the 27th of August, 1819  
Aged 49 Years  
After a severe Illness  
which he bore  
With Christian Fortitude  
Leaving a disconsolate  
Widow and Son  
to Lament his Loss  
a Loss  
also felt by his few Friends  
who knew him.  
In him the Community has been  
Deprived of an honest Man  
and this country of an  
Eminent Artist  
in his Line of  
Natural History Painting  
In which he excelled.  
He is gone  
Depending upon the Mercies  
of his God  
through an atoning Saviour  
Who Writes  
'Our Virtues on Adamant  
Our Vices on a Wave.'  
A Friend  
has given this Tribute  
To his Memory.”

About a mile farther on, at La Perouse, the remains of P re le Receveur are buried, and a memorial erected to his memory. He was one of the naturalists in the French Expedition, under the command of the illustrious, but ill-fated La Perouse, and died on the 17th February, 1788.

Three years after Lewin's decease a re-issue was published in London, in 1822, entitled "A Natural History of the Birds of New South Wales, collected, engraved, and faithfully painted after Nature, by John William Lewin, A.L.S., late of Parramatta, New South Wales." It contained twenty-six plates, being eight more than in the original edition published by Lewin in 1808. The watermark on the plates of the 1822 edition is J. Whatman 1822, and on the paper of the accompanying letterpress the same maker's name, with date 1821. All the species are described under vernacular names only. There is a copy of this edition in the Australian Museum Library, also one purporting to be of the same issue and date, but the watermark on the plates is 1875. Attention has already been drawn to this issue in circulation in a bookseller's descriptive catalogue. The Museum copy of the 1822 edition could never have been "painted after nature" by Lewin, for the base of the forehead and sides of the head of the Crested Shrike are painted yellow, where they should be white.

A second re-issue bearing the same title was published in London in 1838, nineteen years after Lewin's death. A copy of this work has been kindly lent me for examination by the Hon. Dr. Jas. Norton, M.L.C. Below the title is as follows: "New and improved edition, to which is added a list of the 'synonymes' of each species, incorporating the labours of 'T. Gould, Esq., N. A. Vigors, Esq., J. Horsfield, M.D. and W. Swainson, Esq.'" The plates are far more accurately coloured than in the genuine 1822 edition, and bear the watermark of 1838. The watermark on the explanation of plates is 1821. Although two pages of synonyms compiled by Eyton follow the title pages, all the species appear under Lewin's vernacular names. In the "Catalogue of Birds in the British Museum,"<sup>5</sup> Dr. H. Gadow gives a reference "*Certhia fulvifrons*, Lewin, Bds. N.S.W., pl. 22 (1838)." This reference cannot be attributed to Lewin, who had been dead for so many years. Both in the 1822 and 1838 editions this species is referred to in the Explanation to Plate xxii. as the "White-breasted Honey-sucker," and by Eyton in the 1838 edition as *Glyciphila fulvifrons*. Moreover, Lewin is not the authority for the specific name of *Glyciphila fulvifrons*, but Vigors and Hors-

<sup>5</sup> Gadow—Cat. Birds Brit. Mus., ix., 1884, p. 210.

field, who described this species in the "Transactions of the Linnean Society," in 1826, under the name of *Meliphaga fulvifrons*.

Although I have never heard of one, there may be copies of Lewin's original work in private libraries in Australia, more especially in New South Wales, the early settlers in Sydney subscribing between them for sixty-seven copies. Only six copies were subscribed for in London. The Melbourne and Adelaide Public Libraries, I have been informed by their respective Librarians, do not possess a copy. With a manuscript title-page bearing the date of publication as 1813! and without an index, there is one in the Sydney Public Library, presumably an authentic copy of the original edition. It has, however, been reduced in size, both in the letterpress and the size of the plates, the latter eighteen in number, the same as in the first issue, being cut off close to the tinted background, doing away at the same time with the engraver's name and date. The numbers on the plates are marked in with pencil, and the accompanying letterpress is under the vernacular names only. The plates are crudely coloured and the watermark thereon is G. Ansell 1809. The male of *Pachycephala gutturalis*, which is figured under the name of "Orange-breast Thrush," has the throat erroneously coloured yellow instead of white, a glaring mistake which could hardly have been perpetrated by Lewin.

Mr. J. J. Fletcher, the Secretary of the Linnean Society of New South Wales, to who I am indebted for some early references to Lewin, has also kindly brought under my notice three original drawings of Lewin's in the possession of the Society. They were the property of the late Sir William Macleay. The species figured are *Origma rubricata*, *Pachycephala rufiventris*, and *Pachycephala gutturalis*. All are under vernacular names only, and the watermark on the paper on one of the m.s. explanations of the plates is "A. Stace 1798."

JOHN GILBERT.

(Plate xxvii.).

The labours of John Gilbert are so well known, and so closely interwoven in connection with those of John Gould in the latter's great work on "The Birds of Australia," that it is unnecessary to enter into but few details relative to the accompanying plate. Gilbert had been for many years in the employment of the Zoological

Society of London, and had there worked under Gould. After Gould determined to visit Australia to procure material for his new work, he appointed Gilbert his assistant, who made valuable field notes and large collections of bird skins, principally in the Northern and Western portions of the continent. Gilbert returned to England in 1841 and revisited Australia in the following year, procuring more information and specimens in South-western Australia. He continued the good work in 1844 and 1845, while accompanying Dr. Leichardt and his party on their overland expedition from Moreton Bay towards Port Essington, and where, during the journey, he treacherously met his death at the hands of the natives. The following account of the tragic occurrence was sent to Gould by Mr. John Roper, one of the members of the expedition, after his return to Sydney, and was published in the "Proceedings of the Zoological Society" in 1846.<sup>6</sup> As the early volumes of the Society's Proceedings are accessible to only a comparatively few students of Australian ornithology it is here fully transcribed.

"Sydney, 12th May, 1846.

Dear Sir,—As I was one of the party that journeyed from Sydney to Port Essington, and not knowing whether you had been made acquainted with the full particulars of poor Gilbert's death, by Dr. Leichardt or any of the party, thinking the details of his melancholy fate would be read with interest, I shall offer no apology for addressing this to you.

As Mr. Gilbert's log, which has been sent home to you, fully narrates all particulars up to the eventful 28th of June [1845], I shall offer no remarks of my own. At the most northerly point we reached on the east side of the Gulf of Carpentaria, in Lat. 15° 57', and about fifty miles from the coast, we encamped for the night at a small shallow lagoon surrounded by low tea-trees, the country around beautifully open. Having partaken of our usual meal of dried meat about 3 p.m., Gilbert, taking his gun, sallied forth in search of something new—he procured a Climacteris and a Finch, which he skinned before dinner; our scanty meal was soon despatched: poor Gilbert was busily employed plaiting the cabbage tree, intending to make a new hat, which, alas! he never lived to finish. The shades of evening closed around, and after chatting for a short time we returned to our separate tents—Gilbert and Murphy to theirs, Mr. Calvert and myself to ours, and Phillips to his; the Doctor and our two black-

---

<sup>6</sup> Roper—Pro. Zool. Soc., 1846, pp. 79-80.

fellows slept around the fire, entirely unconscious of the evil designs of the natives ; having always found those we had passed so friendly and well disposed, we felt in as great security as you do in the midst of London, lying on our blankets, conversing on different topics. Not one could have closed his eyelids, when I was surprised by a noise as if some persons were throwing sticks at our tent : thinking it must be some trick played on us by our companions, I sat up and looked out ; another volley of spears ; a terrific yell, that will ring in my ears for ever, was raised, and pierced with spears, which I found it impossible to extricate, I sunk helpless on the ground ; the whole body rushed upon us with their waddies, and how it is that our brains did not bespatter the ground, is to me miraculous. These rascals had crept on us under cover of the tea-trees, the tent where Calvert and I were being first in their road, the whole body attacked us ; poor Gilbert, hearing the noise, was rushing from his tent with his gun, when a spear was thrown at him, pierced his breast, and penetrating to his lungs caused internal hemorrhage ; the only words he spoke were these, "Charlie take my gun, they have killed me," when pulling out the spear with his own hands he immediately dropped upon the ground lifeless. Little Murphy, who was by his side at the time he was speared, fired at the black-fellow who had speared him ; Brown fired at the mob beating Calvert and myself, and they immediately retreated, howling and lamenting. Mr. Calvert was pierced with five spears, myself with six, and our recovery is to be attributed to the abstemious way in which we lived. After having the spears pulled out, you may imagine our feelings when we heard Charlie exclaim, "Gilbert is dead"—we could not, would not believe it. Alas ! the morning brought no better tidings—poor Gilbert was consigned to his last and narrow home, the prayers of the Church of England were read over him, and a large fire made upon his grave for the purpose of misleading the blacks, who we thought, would probably return and search the camp upon our departure. It is impossible to describe the gloom and sorrow the fatal accident cast upon our party. As a companion none was more cheerful or agreeable ; as a man none more indefatigable or more persevering ; but it is useless for me to eulogize one so well known to you—one whom you will have cause to regret, and who will ever be remembered by,

Sir,

Yours most truly,

JOHN ROPER."

Although Gilbert was buried in a lonely grave in North Queensland he was not forgotten, "unhonoured, unwept, unsung."

In the historic S. James Church of England, Sydney, built during Governor Macquarie's time in 1820, a mural tablet was erected to his memory by the colonists of New South Wales.<sup>7</sup> Among others, many tablets adorn its walls to perpetuate the memory of different persons closely associated with the early history of the colony. Next to Gilbert's is a tablet erected by the Executive Government to the memory of Edmund Kennedy, Explorer, who was killed by the natives on the 13th December, 1848, and of his nine companions who perished during the exploration of York Peninsula. Among the latter, was Thomas Wall, Naturalist, brother to the first Curator of the Australian Museum. There are also tablets to the memory of William Wentworth, William Sharp Macleay and Alexander Macleay, the latter a member of Committee of the Australian Museum from its first commencement in 1836, until his decease on the 19th July, 1848.

The accompanying plate is reproduced from a photograph taken with the kind permission of the Rev. W. I. Carr-Smith, Rector of S. James Church.

---

<sup>7</sup> A slight error occurs in the date, Gilbert was speared on the 28th, not the 29th of June, 1845.



THE CRANIAL BUCKLER OF A DIPNOAN FISH,  
PROBABLY *GANORHYNCHUS*, FROM THE DEVONIAN  
BEDS OF THE MURRUMBIDGEE RIVER,  
NEW SOUTH WALES.

By R. ETHERIDGE, Junr., Curator.

(Plate xxviii.).

Mr. C. A. Süssmilch, Lecturer on Geology, Technical College, Sydney, favoured me with the loan of a cranial buckler of a Dipnoan fish, obtained by him from the Devonian beds of the Murrumbidgee River. A reproduction of this specimen has been placed in the Museum collection.

The buckler in question so closely resembles one described by Dr. R. H. Traquair, some years ago, as *Ganorhynchus woodwardi*,<sup>1</sup> that I am induced to publish a description of the new specimen under the same generic name, as *G. süssmilchi*. Dr. Traquair's specimen consisted of the anterior portion of the head only, but unfortunately nothing was known, at the time of his description "regarding the geological formation, or the locality." It consisted of "the extremity of the snout of a very large fish, probably 4 or 5 feet long." Dr. Traquair's description, epitomised, is as follows, so far as it concerns the present fossil. The fragment is semilunar in form, with a superior arched ganoid surface forming part of the upper aspect of the snout, the anterior rounded margin being the front edge of the upper lip. When placed in its natural position, with the labial margin horizontal, the superior surface slopes downwards and forwards in the middle line at an angle of 45°, and is arched at the sides. The surface is smooth, glossy, finely reticulate-punctate, and exhibits no trace either of sutures or external nasal organs. Near the labial margin, the small punctures of the superior ganoid surface give place to larger ones. On viewing this snout from below it is seen to be flattened centrally and laterally, and with a shallow central emargination or indentation, set on its edge with a row of six small blunted tooth-like projections. On each side is a deep

<sup>1</sup> Traquair—Geol. Mag., x., 1873, p. 552, pl. xiv.

rounded notch, which Traquair considers to represent the position of the anterior nasal opening. The author concluded his description in these words—"Our fossil is certainly neither *Dipterus* nor *Ceratodus*; *Cheirodus* is known only by its teeth: and as to *Ctenodus*, the front of the head has not yet been discovered, so that all evidence is wanting to connect it with that genus. It seems, therefore, in these circumstances, best to frame a new genus for its reception."

Dr. Traquair's description of this remarkable fossil seems even now to be practically all that is known of it, for Dr. A. S. Woodward writes<sup>2</sup> of *Gauorhynchus* as "a provisional genus at present incapable of definition, comprising large Paleozoic Dipnoan fishes in which the extremity of the snout (as also presumably all the external headbones) is enveloped in a thick layer of punctate ganoin."

The specimen discovered by Mr. Süssmilch is externally much more complete than that figured by Traquair. It consists of the snout and most of the plates of the cranial buckler covered with glossy ganoin densely and minutely pitted, and separated from one another by fairly-well marked sutures. This cranial shell, 2 mm. thick along the posterior edge, is strongly arched from side to side, but unarched between the anterior and posterior extremities, so far as preserved. In its present condition it measures four inches from end to end, and three inches transversely at its greatest width, without following the curve. The plates are more or less distinguishable to within one inch of the snout extremity, this portion being, as in the corresponding but much larger area of *G. woodwardi*, devoid of sutures, and the punctæ of the polished surface interspersed with others of a larger diameter. The snout is fairly perfect, but the posterior end of the specimen is fractured and imperfect. Dr. Traquair's description of the fore-under surface can almost be applied to the corresponding part of Mr. Süssmilch's fossil. We see the arched and flattened front of the snout and margin of the upper lip, the rounded superior edge of the former fading into the surface of the shield. On this labial margin the ganoin has been worn off, but leaving traces of punctæ larger than any of those on the upper surface. The central portion of the lower margin of the lip, when viewed from the front, is convex, with on each side a shallow rounded notch, the anterior nasal opening according to Traquair. The median indentation of this lip edge in *G. woodwardi* is not visible in *G. süssmilchi* until the specimen is turned completely upside-

---

<sup>2</sup> Woodward—Brit. Mus. Cat. Foss. Fishes. Pt. ii., 1891, p. 245.

down, and is even then, faint and inconspicuous, and there are no tooth-like projections visible so far as the lower portion of the specimen has been developed. The ends of the lateral projecting portions of the labium are slightly enlarged and blunt, but not incurved.

The polygonal cranial plates are not bilaterally symmetrical, in fact they are very irregularly arranged. In *Dipterus*, even, Traquair says<sup>3</sup> "it is difficult to trace any exact correspondence between them and the cranial roof-bones of ordinary Ganoids and Teleostei." I certainly hoped to be able to institute a comparison between these cranial plates and those of *Dipterus* as restored by Dr. C. H. Pander,<sup>4</sup> but those of our fossil do not appear to correspond with the arrangement shown in his restoration: even in the latter they are not wholly bilaterally symmetrical. For instance, assuming Pander's restoration to represent the complete cranial buckler of *Dipterus*, his median occipital is one of the largest plates of the series, and is posteriorly terminal. On the other hand, the largest plate in the median line of our buckler is not terminal and the two flanking plates on either side do not correspond in outline or size with one another. In Pander's figure the anterior semicircle is composed of three large plates, a central and two lateral, but these are not shown in Hugh Miller's representation<sup>5</sup> of the same. In the present instance the dorsal surface of the snout evinces no sign of subdivision that I can detect, nor does that of *G. woodwardi*, Traq.

As compared with the snout of *G. woodwardi*, that of our specimen is less dome-like, much flatter above, and with a greater degree of spread between the rounded lateral projections in proportion to its size. This less dome-like outline is apparent in a side view (Pl. xxviii., fig. 2) if the fossil be placed in its natural position, corresponding with Traquair's fig. 3, Pl. xiv. Speaking in general terms it may be said that the labial features of *G. sussmilchi* are not so pronounced as those of *G. woodwardi*—the nasal openings are not so deeply excavated, nor is the median emargination visible until the buckler is seen from below.

The history of *G. woodwardi* is a curious one. It appears that when Mr. C. König was Keeper of the Geological Department of the British Museum, the specimen came under the notice of the illustrious Agassiz, who regarded it as the intermaxillary bone of *Megalichthys*. Years after Dr. H. Woodward called Dr. Tra-

<sup>3</sup> Traquair—Ann. Mag. Nat. Hist. (5), ii., 1878, p. 9.

<sup>4</sup> Pander—Die Ctenodipterinen, 1858, pl. i., f. 1.

<sup>5</sup> Miller—Footsteps, 13th ed., 1871, p. 58, f. 20.

quair's attention to this fossil, at the same time expressing the opinion that it belonged to a new genus: in this view the latter concurred. The "specimen formed part of the old collection of the British Museum, of which there are no records, hence its history as to from whom and whence it came is wanting. Judging, however, from its general aspect, one might readily be tempted to infer that it was of Palæozoic age."<sup>6</sup> The matrix is described as a dull grey argillaceous limestone.

In the present instance the matrix is a blue-black limestone, and both this colour and the mode of weathering are characteristic of the Murrumbidgee Devonian limestones. If my conception of this fish buckler is the correct one, it confirms Traquair's reference of *G. woodwardi* to the Palæozoic. The thought that perhaps the latter may have originally come from one or other of the New South Wales limestone localities is perhaps permissible.

The specimen was found by Mr. Süssmilch on Portion 44, Parish of Taemas, Co. Cowley (Murrumbidgee River), and is named in his honour.

---

<sup>6</sup> Traquair—Geol. Mag., x., 1873, p. 554.

MINERALOGICAL NOTES: No. III.—AXINITE,  
PETTERDITE, CROCOITE, AND DATOLITE.

By C. ANDERSON, M.A., B.Sc., Mineralogist.

(Plates xxix.—xxxiii.).

AXINITE.

BOWLING ALLEY POINT, NEAR NUNDLE, NEW SOUTH WALES.

(Plate xxix.).

Axinite was first found at this locality by Mr. D. A. Porter,<sup>1</sup> to whom I am indebted for notes as to its mode of occurrence. The exact location is about a quarter of a mile from the foot-bridge over the Peel River, where the mineral is found associated with green epidote in sedimentary rocks much altered by intrusive diorite: it occurs sometimes in crystalline veins, but the best specimens are obtained in cavities, where the crystals have grown freely, accompanied by small well-formed quartz prisms. Good crystals are rare and minute; larger, more imperfect ones can be found measuring up to 15 mm. The colour is brownish with a violet tinge on a fresh fracture.

Three of the best crystals, each measuring about 3 mm., were removed from the matrix, and their faces determined on a two-circle goniometer; owing to their mode of attachment the crystals were fractured in removal along a line roughly parallel to the edge *b c* (Pl. xxix., figs. 3, 4). After several trials the habit was made out, but it was found impracticable owing to the small size and unsatisfactory nature of the prism faces to centre the crystals in the conventional position; instead, the most prominent zone—either  $[010, 111]$  or  $[1\bar{3}0, 021]$ —was made equatorial and the available angles determined, after which the crystal was inverted, and, with the same zone as before equatorial, the angles yielded by the faces on the other end measured. By plotting the co-ordinates in stereographic projection, the forms were easily identified by the aid of Penfield's invaluable protractors. From the measurements, the normal angles were calculated for comparison with the theoretical values calculated from Goldschmidt's "Winkeltabellen."<sup>2</sup> This method, though it does not afford direct comparison of measured with calculated angles, is sufficient to prove the correctness of identification.

In habit the crystals are uniformly tabular on *c* ( $1\bar{1}1$ ), which

<sup>1</sup> Liversidge—Journ. Roy. Soc. N.S. Wales, xviii., 1884 (1885), p. 45;

Porter—*Ibid.*, xxii., 1888 (1889), p. 82.

<sup>2</sup> Goldschmidt—Kryсталlographische Winkeltabellen, 1897, p. 58.

is the only large face; it is strongly striated parallel to its intersection with  $M$  ( $\bar{1}\bar{1}0$ ), and gives a multiple and blurred image.

I have adopted Dana's position and lettering, converting Goldschmidt's indices by the transformation equations,  $h' = -k$ ,  $k' = 2h + k$ ,  $l' = l$ , where the dashed letters refer to Dana's indices. A table showing the equivalent letters and indices according to Dana and Goldschmidt respectively will be found below, p. 137, under the description of axinite from Colebrook Tasmania.

The following table of angles is constructed from measurements on the specimen shown in Pl. xxix., fig. 4 (which gives the best reflections), with the exception of the angles  $M \wedge z$ ,  $w \wedge Y$  and  $w \wedge f$ , which were got from the crystal drawn in orthogonal and clinographic projection in Pl. xxix., figs. 1 and 2.

Forms.	Calculated from Measurements.		Calculated from Winkeltabellen.		Difference.
	o	r	o	r	
$h : m = 010 : 110$	32	41	32	54	13
: $M = \quad : \bar{1}\bar{1}0$	77	29	77	30	1
: $w = \quad : \bar{1}\bar{3}0$	137	56	137	46	10
: $x = \quad : 111$	46	2	45	58	4
: $r = \quad : \bar{1}\bar{1}1$	87	7	86	47	20
: $u = \quad : \bar{1}\bar{3}1$	130	39	130	29	10
$m : s = 110 : 201$	28	6	28	0	6
: $r = \quad : \bar{1}\bar{1}1$	65	6	64	23	43
$M : r = \bar{1}\bar{1}0 : \bar{1}\bar{1}1$	45	25	45	12	13
: $z = \quad : \bar{1}\bar{1}2$	63	45	63	34	11
: $e = \quad : 001$	89	48	89	55	7
$w : d = \bar{1}\bar{3}0 : \bar{2}\bar{4}1$	31	43	31	44	1
: $r = \quad : \bar{1}\bar{1}1$	64	14	64	13	1
: $y = \quad : 021$	123	40	123	6	34
: $u = \quad : \bar{1}\bar{3}1$	32	32	32	27	5
: $e = \quad : 001$	82	58	83	6	8
: $o = \quad : \bar{1}\bar{3}2$	121	12	121	6	6
: $Y = \quad : \bar{1}\bar{3}1$	142	47	143	2	15
: $f = \quad : 011$	108	8	108	30	22

## MOONBI, NEW SOUTH WALES.

(Plate xxxi., figs. 1, 2).

Axinite was recorded from this locality by Mr. D. A. Porter<sup>3</sup> in 1884; at that time its occurrence *in situ* was not known, but recently Mr. Porter has traced it to its parent rock at a point about two miles south-east from Moonbi Railway Station. The mode of occurrence is practically the same as that of the Bowling Alley Point axinite: from a genetic point of view the two are probably identical.

One of the Museum specimens is fully as large as one's fist, and entirely composed of somewhat coarse crystals which are often built up of several individuals in approximately parallel position, recalling the sheaf-like aggregates so common with stilbite. Smaller crystals adapted for goniometric determination were obtained from crevices, where, as at Bowling Alley Point, they are accompanied by crystallised quartz.

Two fragmentary crystals, each between 2 and 3 mm. long, were measured, and drawn (Pl. xxxi., figs. 1, 2) according to their natural development. The zone [010,  $\bar{1}\bar{1}\bar{1}$ ] was made equatorial as before, and the normal angles obtained by calculation from the measured co-ordinates. The habit is similar to that of the Nundle axinite, and  $r$  ( $\bar{1}\bar{1}\bar{1}$ ) is, as in that, striated parallel to its intersection with  $M$  ( $\bar{1}\bar{1}\bar{0}$ ).

## COLEBROOK MINE, DUNDAS, TASMANIA.

(Plate xxx. ; Pl. xxxi., fig. 3).

This occurrence was first put on record by Messrs. Petterd and Twelvetrees in their paper "On the Occurrence of Limurite in Tasmania."<sup>4</sup> In that paper and two supplementary notes<sup>5</sup> the authors have discussed the field relations and microscopic characters of this interesting axinite-bearing rock, which is paralleled only by the original limurite of the Pyrenees.<sup>6</sup>

<sup>3</sup> Porter—Journ. Roy. Soc. N.S. Wales, xviii., 1884 (1885), p. 80.

<sup>4</sup> Petterd and Twelvetrees—Proc. Roy. Soc. Tas., 1897 (1898), pp. 1-6, pl.

<sup>5</sup> Petterd and Twelvetrees—*Loc. cit.*, 1898-9 (1900), pp. 1, 2 and 56-59.

<sup>6</sup> Zirkel—Neues Jahrb. für Min., 1879, p. 379.

The locality is North-east Dundas between Ringville and Rosebery, where the limurite forms a lenticular contact mass bounded on the east by slate of probably Silurian age, and on the west by serpentine.

From hand specimens in the Museum collection it appears that the macroscopic associates of axinite are calcite chiefly in veins, chalcopyrite, pyrrhotite, actinolite in radiating aggregates, and datolite in crystalline masses. To this list Petterd and Twelve-trees from microscopic examination add chlorite, tourmaline, danburite and sphene, while they find that the main mass of the rock is a pyroxenite which here and there receives accessions of axinite and other minerals, thereby becoming "limurite."

The axinite occurs as well-defined crystals, sometimes reaching a length of 15 or 16 mm., embedded in calcite or datolite and disseminated through the pyroxene. It is not easy to find a detachable crystal suitable for the goniometer, and I am indebted to Mr. W. F. Petterd for the loan of three crystals, each fragmentary but better than any in our collection and adequate for measurement. The colour is clove brown; the specific gravity, determined on a crystal weighing 1.0085 gram, was found to be 3.270.

The habit recalls that of the Nundle and Moonbi axinite, the specimens having the same tabular extension parallel to  $r$  ( $1\bar{1}1$ ). Here however  $z$  ( $1\bar{1}2$ ) is also a face of considerable size; both  $r$  and  $z$  are deeply striated parallel to their intersection. The prism faces are not prominent and are slightly striated parallel to the vertical axis.

The crystal from which the figures were made measures approximately 8 mm. in greatest diameter; it is broken across in the direction of the edge  $r$   $x$ . After preliminary "one-circle" measurement in two zones, several faces were identified and the habit made out; the crystal was then mounted with the prism zone normal to the vertical circle, and the co-ordinate angles obtained. With the exception of  $r$  and  $z$ , which have both faces present, all the forms were determined from single planes; the faces  $f$  ( $011$ ),  $g$  ( $021$ ) and  $Y$  ( $1\bar{3}1$ ) gave no distinct signal and were measured in the position of brightest illumination. Owing to the difficulty of accurately centring, and the small size and imperfections of some of the faces, the measured and calculated angles do not always agree closely.

In the table below the calculated angles are taken from Goldschmidt's "Winkeltabellen," but Dana's position and lettering have been adopted as before.



Form.		Measured.		Calculated.		Difference.	
Goldschmidt.	Daup.	$\phi$	$\rho$	$\phi$	$\rho$	$\phi$	$\rho$
<i>m</i>	001	-89	7	-90	7	1	35
<i>c</i>	110	0	90	0	90	0	12
<i>M</i>	010	(102 30)	90	102	90	—	16
<i>w</i>	130	60	90	60	90	17	31
<i>u</i>	110	134	90	135	90	45	16
<i>l</i>	100	152	90	151	90	55	52
<i>z</i>	012	-164	26	-164	27	5	40
<i>r</i>	011	-172	44	-172	45	2	27
<i>f</i>	102	103	25	106	27	2	12
<i>a</i>	101	103	48	104	49	34	29
<i>b</i>	101	-78	55	-78	55	23	16
$\delta$	132	-115	40	-115	40	23	24
<i>Y</i>	131	56	54	57	53	48	57
<i>x</i>	111	137	46	138	48	1	13
<i>u</i>	131	-117	29	-117	16	13	10
<i>s</i>	201	153	30	153	49	19	3
<i>d</i>	241	-140	20	-140	52	32	50
<i>q</i>	151	78	48	79	33	45	39

## PETTERDITE NOT A NEW MINERAL.

(Plate xxxi., fig. 4; Pl. xxxii.).

In 1901 Mr. W. H. Twelvetrees, Government Geologist of Tasmania, described under the name petterdite (in honour of Mr.

W. F. Petterd, of Launceston) a supposed new oxychloride of lead, which was found in the upper workings of the Britannia Mine, Zeehan, Tasmania, as groups of white hexagonal plates in a quartz gangue containing disseminated pyrites; the analysis was made by Mr. O. E. White of Hobart.<sup>7</sup> Some time back Mr. Petterd kindly lent me for examination his best specimen (Pl. xxxii.), also some detached crystals; on a chemical and crystallographic study of this material the following conclusions are based.

For a description of the physical characters I may refer to the original account which is substantially correct: no macles however were observed, and the hardness is not 1.5 as stated, but lies between 3 and 4, the mineral being harder than calcite and softer than fluorite.

*Crystallography.* Three crystals, each about 4 mm. in diameter were measured on a two-circle goniometer. The angles obtained are only approximate, as the faces are interrupted, wavy and slightly curved, usually yielding only a vague patch of light in the telescope. The basal plane is rough and gives no reflection, therefore the crystals were centred by the prism faces. The system is hexagonal, the forms present being  $c$  (0001), the prism (10 $\bar{1}$ 0), and the first and second order pyramids (10 $\bar{1}$ 1) and (11 $\bar{2}$ 1). Pyramidal faces do not occur on all the crystals and the pyramid (10 $\bar{1}$ 1) is the commoner and better developed.

From the measurement  $0001 \wedge 10\bar{1}1 = 38^\circ 42'$  the length of the vertical axis was found to be .6938. The measured angle  $0001 \wedge 11\bar{2}1$  is  $53^\circ 20'$ , calculated  $54^\circ 13'$ .

*Composition.* In the endeavour to discover, if possible, the affinities of this apparently new species, the original analysis given below was more closely scanned.

Pb O	...	...	...	74.04 %
As <sub>2</sub> O <sub>5</sub>	...	...	...	2.60
P <sub>2</sub> O <sub>7</sub> [ <i>sic</i> ]	...	...	...	2.10
Sb <sub>2</sub> O <sub>5</sub>	...	...	...	.50
Cl	...	...	...	20.00
				99.24

To deduce a formula from these figures it is necessary to assume an unlikely combination such as,—

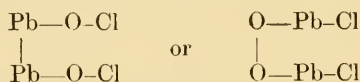

<sup>7</sup> Twelvetyrees—Rept. Secy. Mines Tas., 1900-1 (1901), p. 356, pl.;  
*Id.*—Proc. Roy. Soc. Tas., 1900-1 (1902), p. 51, pl.

otherwise we must suppose that the mineral contains 20 % of free chlorine.

When this difficulty was pointed out to Mr. Petterd, whose enthusiasm in mineralogical research is well known, he generously gave me permission to make a new analysis of his material. The result has been to show that, by some mischance, the percentages for chlorine and arsenic pentoxide have been transposed. To this accidental circumstance, and the somewhat unusual crystal habit, we owe the name *petterdite*, which must now lapse into the synonymy of *mimetite*, where it may perhaps be retained for crystals of a habit similar to this (Pl. xxxi., fig. 4).

Two partial analyses were made. In I, .5589 gram was taken, dissolved in cold, dilute nitric acid and the chlorine precipitated by silver nitrate. The silver chloride obtained weighed .0557 gram, giving 2.46 % chlorine. From the filtrate silver was removed by hydrochloric acid in slight excess and lead thrown down by sulphuric acid in alcoholic solution, the precipitate being subsequently treated in the crucible with sulphuric acid to convert any lead chloride into sulphate. The lead sulphate weighed .5861 gram, equivalent to 77.16 % oxide. Alcohol was evaporated from the filtrate by gentle heat and arsenic and phosphoric acids precipitated together by "magnesia mixture." The precipitate was approximately weighed after gentle ignition (reckoned as pure *pyro-arsenate* it was equivalent to about 22 % arsenic pentoxide), redissolved in hydrochloric acid and a current of sulphuretted hydrogen passed through the solution. A bulky yellow precipitate of sulphide of arsenic came down and was filtered off. Part of this was accidentally lost in oxidising to arsenic acid; the remainder was thrown down by "magnesia mixture," and ignited with addition of some ammonium nitrate crystals; it weighed .0803 gram, giving 10.63 % arsenic pentoxide. The filtrate from sulphide of arsenic was concentrated and phosphoric acid estimated by precipitation with "magnesia mixture"; magnesium *pyro-phosphate* weighed .0222 gram, equal to 2.53 % phosphorus pentoxide. Hence we may put arsenic pentoxide as comprising 18 or 19 %.

For analysis II, .6391 gram was dissolved in nitric acid, the solution evaporated on the water bath, lead thrown down by sulphuric acid and filtered off. From the filtrate, arsenic and the remaining traces of lead were removed by sulphuretted hydrogen, treated with sodium sulphide solution, the small residue of lead sulphide filtered off, converted into sulphate and added to the main portion, the total weight being .6699 gram, making 77.12 % oxide of lead. In the filtrate from lead

sulphide, arsenic was precipitated by addition of hydrochloric acid, oxidised by strong nitric acid and estimated as magnesium pyro-arsenate, which weighed 1550 gram, yielding 17.95% arsenic pentoxide. Phosphorus was estimated as before in the filtrate from the sulphides of lead and arsenic. The result was 0.248 gram magnesium pyro-phosphate, equivalent to 2.47% phosphorus pentoxide.

Antimony if present would be left on the solution of sulphide of arsenic in nitric acid but its presence was not proved.

Thus we arrive at the conclusion that petterdite is really mimetite containing an appreciable amount of phosphoric, isomorphously replacing arsenic acid; chemically it would be classed with the variety campylite, and it is noteworthy that Twelvetrees mentions campylite as sometimes associated with petterdite,<sup>8</sup> while Petterd in another place alludes to campylite as occurring in pale, *almost white* crystals at the Britannia Mine.<sup>9</sup>

The result of analyses is tabulated below; III is the mean of analyses I and II, under IV is given for comparison Rammelsberg's analysis of campylite from Cumberland, England,<sup>10</sup> while V is the theoretical composition for 2 (3 Pb<sub>3</sub> P<sub>2</sub> O<sub>8</sub>. Pb Cl<sub>2</sub>) + 7 (3 Pb<sub>3</sub> As<sub>2</sub> O<sub>8</sub>. Pb Cl<sub>2</sub>).

	I.	II.	III.	IV.	V.
Cl ...	2.46	not det.	2.46	2.41	2.44
P <sub>2</sub> O <sub>5</sub> ...	2.53	2.47	2.50	3.34	3.25
As <sub>2</sub> O <sub>5</sub>	not det.	17.95	17.95	18.47	18.40
Pb O ...	77.16	77.12	77.14	76.97	76.47
			100.05	101.19	100.56

The angular measurements obtained from petterdite may now be compared with the angles given by Goldschmidt for mimetite.

<sup>8</sup> Twelvetrees—*Loc. cit.*

<sup>9</sup> Petterd—*Proc. Roy. Soc. Tas.*, 1902 (1903), p. 20.

<sup>10</sup> Rammelsberg—*Pogg. Ann.*, xci., 1854, p. 316.

Forms.		Measured.		Calculated.		Difference.		No. of observations.
		$\phi$	$\rho$	$\phi$	$\rho$	$\phi$	$\rho$	
<i>c</i>	0001	—	—	—	—	—	—	—
<i>m</i>	10 $\bar{1}$ 0	0 15	90 6	0 0	90 0	0 15	0 6	8
<i>x</i>	10 $\bar{1}$ 1	0 17	38 42	0 0	40 2	0 17	1 20	7
<i>s</i>	11 $\bar{2}$ 1	30 43	53 20	30 0	55 30	0 43	2 10	5

The agreement, especially for the important 0001  $\wedge$  10 $\bar{1}$ 1 and 0001  $\wedge$  11 $\bar{2}$ 1, is by no means close, but a considerable latitude may be claimed on account of the poor quality of material and the small number of observations, which were limited by my desire to mutilate a handsome specimen (Pl. xxxii.) as little as possible.

## CROCOITE,

## MAGNET MINE, TASMANIA.

(Plate xxxi., fig. 5).

Of this mineral I have examined five specimens with crystals *in situ*, four lent by Mr. W. F. Petterd and one by Mr. G. W. Card, also a number of loose crystals belonging to Mr. Petterd.

The matrix is a rather friable limonite in which the crocoite is partly embedded. The largest specimen carries numerous crystals averaging about 2 mm. in length; in the other cases where *in situ* the crystals are quite minute and had previously been referred to carminite (arsenate of lead and iron) by Petterd,<sup>11</sup> who however informed me in forwarding the specimens that he doubted whether this identification was correct. Qualitative analysis proves their composition to be chromate of lead, and, like the larger crystals, they agree morphologically with crocoite. Hence carminite must be deleted from the list of Tasmanian minerals. Of the loose crystals, which are all imperfect, some measure about 10 mm. in length.

The habit is remarkably constant throughout, the crystals being prismatic by extension along the zone axis *b t* (Pl. xxxi., fig. 5). This zone being the only well-developed one was made equatorial and a stereogram constructed from the co-ordinate angles obtained;

<sup>11</sup> Petterd—Proc. Roy. Soc. Tas., 1902 (1903), p. 20.

from this the forms were identified by means of Penfield's protractors and the identification was confirmed by calculation of the normal angles. All the faces are small with the exception of  $t$  (111) which gives an excellent image, and a peculiar rounded face which could not be determined but is possibly  $x$  (301); the pinacoid  $b$  (010) is very small when present.

The table contains some of the results of measurement compared with the theoretical angles given by Goldschmidt.

Forms.	Calculated from Measurements.		Calculated from Winkeltabellen.		Difference.
	o	i	o	i	
$b : m = 010 : 110$	46	43	46	51	8
$: t = : 111$	59	35	59	36	1
$: v = : \bar{1}11$	53	38	53	49	11
$: k = : \bar{1}01$	89	44	90	0	16
$m : t = 110 : 111$	34	3	33	56	7
$m' : v = \bar{1}10 : \bar{1}11$	40	51	40	38	13

### DATOLITE.

COLEBROOK MINE, DUNDAS, TASMANIA.

(Plate xxxiii.).

This mineral was first obtained in sinking a shallow shaft in the western portion of the limurite outcrop.<sup>12</sup> It is found associated with axinite, calcite and other minerals as already described under axinite, and sometimes occurs in large brilliant crystals. It is colourless, greenish or yellowish.

*Crystallography.* The crystals have mutually interfered during growth, but one small projecting crystal was found and measured. This crystal is shown in ideal and actual development in Pl. xxxiii., figs. 1-4; fig. 5 shows the distribution of forms and the chief zones.

The habit of the figured crystal seems characteristic so far as can be judged by inspection of others: it is prismatic by extension parallel to the  $a$  axis and measures about 6 mm. in length. It is fairly rich in forms, but as is usual with datolite many of the faces are wavy and give poor reflections; the three faces  $\iota$  ( $\bar{2}12$ ),  $\pi$  ( $\bar{2}31$ ), and  $x$  (102) are dull and were measured in the position of maximum illumination.

As in the case of axinite, Goldschmidt and Dana choose

<sup>12</sup> Petterd—Proc. Roy. Soc. Tas., 1897 (1898), p. 63.

different positions and axes. The crystal was mounted on the goniometer with Goldschmidt's prism zone equatorial so that the measured, could be directly compared with the calculated angles; the indices were transformed to Dana's axes by the equations  $h' = l$ ,  $k' = -k$ ,  $l' = 2h$ . The angles are tabulated below.

Form.		Measured.		Calculated.		Difference.	
Goldschmidt.	Dana.	$\phi$	$\rho$	$\phi$	$\rho$	$\phi$	$\rho$
<i>a</i>	100	90	0	90	0	0	0
<i>c</i>	001	90	3	90	0	10	9
<i>t</i>	013	67	3	67	7	8	3
<i>m</i>	011	38	5	38	18	5	3
<i>M</i>	110	0	28	0	14	24	4
<i>r</i>	102	90	44	90	0	11	31
<i>l</i>	212	-56	0	-57	32	32	1
<i>e</i>	112	-57	49	-57	36	13	11
<i>n</i>	111	38	39	38	27	12	1
<i><math>\mu</math></i>	114	-72	64	-72	25	15	26
<i><math>\kappa</math></i>	115	-75	68	-75	46	2	41
<i><math>\lambda</math></i>	113	-67	57	-67	5	13	1
<i><math>\pi</math></i>	231	-13	43	-14	36	56	56

*Composition.* The method of analysis is that described by Gooch<sup>13</sup> with modifications suggested by Penfield and Sperry,<sup>14</sup> boric anhydride being distilled with alcohol, caught in strong ammonia solution, transferred to a basin and evaporated over lime as described in a former paper.<sup>15</sup> For this determination 1.1478 gram was fused with sodium carbonate, exhausted with water, filtered, the filtrate acidified with nitric acid and distilled. Water was determined directly in a Penfield tube on .6108 gram mixed with previously ignited lime to minimise the risk of expelling boric anhydride. The other constituents were estimated in another portion weighing about a gram. The result of analysis is appended (I) together with an analysis by Whitfield<sup>16</sup> of datolite from Bergen Hill, New Jersey (II).

	I.	II.
H <sub>2</sub> O ... ..	6.48 %	6.14 %
Si O <sub>2</sub> ... ..	36.28	35.74
Al <sub>2</sub> O <sub>3</sub> } ... ..	.95	.31
Fe <sub>2</sub> O <sub>3</sub> }		
Fe O ... ..		
Ca O ... ..	35.21	35.14
B <sub>2</sub> O <sub>3</sub> ... ..	20.48	22.60
	99.40	99.93

In conclusion I have to acknowledge my indebtedness to Messrs. W. F. Petterd and D. A. Porter, for the loan of specimens and for much valuable information, and to Professor T. W. E. David, B.A., Trustee, for permission to use the goniometer in the Geological Department of the University of Sydney.

<sup>13</sup> Gooch—Bull. U.S. Geol. Survey, No. 42, 1882, p. 64.

<sup>14</sup> Penfield and Sperry—Am. Journ. Sci., (3), xxxiv., 1887, p. 222.

<sup>15</sup> Anderson—Rec. Austr. Mus., v., 1904, p. 128.

<sup>16</sup> Whitfield—Bull. U.S. Geol. Survey, No. 55, 1889, p. 59.



## A SYNOPSIS OF AUSTRALIAN ACARINA.

By W. J. RAINBOW, F.L.S., F.E.S., Entomologist.

(Figs. 33—37).

Mr. Nathan Banks, the well-known American Arachnologist, has recently published a valuable, if brief, "Treatise on Acarina, or Mites."<sup>1</sup> The work is rendered the more acceptable to the student of Acarology, from the fact that it gives not only a key to the numerous families and genera, but also a sketch of the life-histories of many species, some of which are of world-wide distribution.

Notwithstanding the fact that the Acarina "have always attracted," as Banks points out in his preface, "considerable interest, both from their minute size and because of the remarkable habits of many species," comparatively little is known about them systematically. Many species have been described from time to time, by a number of authors, but, to again quote Banks "few have really studied them." The literature dealing with the subject is very scattered, and much of it unsatisfactory.

The most reliable workers have been Michael in England, whose masterly monographs of "British Oribatidæ"<sup>2</sup> and "British Tyroglyphidæ"<sup>3</sup> have appeared at different times; and among continental students, Neumann, whose "Revision de la Famille des Ixodidés"<sup>4</sup> is a valuable production, and must take its place as a standard work. Other European acarologists of repute are Trouessart, Kramer, Canestrini, Nalepa and Berlese. The writings of these workers are spread over many publications. It is interesting to note that more species have been described of late years—principally by Trouessart and Canestrini—from New Guinea, than from Australia.

Nearly all parasitic Acarids follow the distribution of their hosts, and so frequently become widely diffused, but a few non-parasitic forms are common in widely separated regions. Most of the latter, as well as some phytophagous species, distribute themselves naturally. There are a number of non-parasitic mites

---

<sup>1</sup> Banks—Proc. U. States Nat. Mus., xxviii., 1904, pp. 1-114.

<sup>2</sup> Michael—British Oribatidæ, Ray Soc., 1884 and 1888.

<sup>3</sup> Michael—British Tyroglyphidæ, *loc. cit.*, 1901.

<sup>4</sup> Neumann—Mém. Soc. Zool. France, ix., 1905, pp. 1-44; *ibid.*, x., 1897, pp. 324-420; *ibid.*, xii., 1898, pp. 107-294; *ibid.*, xiv., 1901, pp. 249-372.

which have developed a remarkable nymphal form, termed technically *Hypopus*. This nymph has a number of tiny sucking discs on the ventral surface at the posterior extremity, which enables it to adhere to some other animal, and so be carried from place to place, until it finds a suitable locality. Extreme cold or excessive moisture has little effect upon the species. Some species are of myrmecophagus habits, and these are of very restricted range.

In respect of geographical distribution, many of the species of this order are almost, if not quite, world-wide. This is only natural, seeing that some of these animals are parasitic on man, domestic animals—both great and small—and economic and ornamental plants. Admitting this, it follows, therefore, that the study of the Acarina is of paramount importance, and hence worthy of careful and systematic study. Many terrestrial animals in their wild state—mammals, birds, reptiles, insects, as well as fresh-water and pelagic forms, have Acarid parasites, some of which are harmful and some beneficial; others are parasites upon parasites. Again, some Acarina, so far as we are at present able to judge, have no economic importance whatever.

The life of an Acarid may be divided into four distinct stages: the egg, larva, nymph and adult. The greater majority of Acarians are oviparous; a few are vivi-, or ovo-viviparous, and those of one genus, *Pediculoides*, Targioni-Tozzetti, are recorded as bringing forth adult males and females. One species of this genus, *P. alastoris*, Frogg., occurs near Sydney.

Banks summarises the general plan of development as follows: "The egg is usually deposited by the female. Often within this egg, while the embryo is developing, an inner membrane is formed which encloses the young mite; this stage is the 'deutovum.' The outer shell may be cracked so as to show this membrane, or it may be wholly discarded. The larva at birth has but six legs. It feeds for a while, then passes into a resting stage which in time discloses the eight-legged nymph. The added pair of legs is the fourth, at least usually. During the nymphal period the mite may moult one or more times and change its appearance, but is always destitute of true genital orifices. At the end of the nymphal stage it passes again into a quiescent condition, and in due time moults into the adult mite. During these resting stages much of the internal anatomy of the mite may undergo histolysis, each new stage being rebuilt from the disintegrated tissues of the preceding stage. The genital organs are, however, not effected by these histolytic processes."<sup>5</sup>

---

<sup>5</sup> Banks—Proc. U. States Nat. Mus., xxviii., 1904, pp. 7-8.

Upon the question of natural enemies, Banks points out that most mites have few enemies beyond their predatory relatives, but, "there are, however, various cases of protective resemblance, especially among the immature forms. No examples of mimicry, I think, are known."

The Acarina is a very extensive order of the class Arachnida, and many of the species comprising it are remarkable for their minuteness and diversity of form, as well as their marvellous life-histories. A great number of the parasitic species have become, as some writers have shown, distinctly modified in organisation; and owing to this, and the fact that their affinities with the typical Arachnida are so masked by degeneration, it has been urged that it would be more convenient and natural to assign them to an order by themselves. Against this, it is contended that most of the free-living (non-parasitic) species have departed least from the typical Arachnid form, and that they display many affinities to the Solpugids and Phalangids. The majority of Aracologists, therefore, regard this group as a branch of the true Arachnida.

It is difficult to draw up a table of characters sufficiently comprehensive to include the whole group, but the following summary may be of service:

*Cephalothorax and Abdomen.*—These segments are united, the fusion being so complete that in many species they are welded into one mass; in some forms however, they are distinct. The body is often provided with hairs and bristles.

*Eyes.*—Often wanting. When present they are simple; there are usually two pairs, each of which are placed close to the outer angle; more rarely there is only a median pair.

*Mouth.*—Adapted for sucking; mandibles partially united, and form with a plate (*epistome*) and the *labium* a beak, known as the *rostrum* or *capitulum*, the latter often separated from the cephalothorax by a membranous joint; mandibles formed for piercing, sometimes provided with a pair of "nippers" at the tip, and sometimes simply pointed.

*Legs.*—Commonly eight in the adult form, and six in the larval. The Eriophyidæ, however, are unique in that there are never more than four in either adult or larva. In *Pteroptus*, Dufour (Gamassidæ), there are eight, both in larva and adult. The legs are arranged in pairs, two of which are seated well forward, and two behind; the latter apparently arise from the abdomen, but as Banks remarks, this is probably not the case; it is "rather that the coalescence of the abdomen and cephalo-

thorax has effaced the true outlines of these portions." The embryonic forms of *Gamasus*, Latr., and *Ixodes*, Latr., have four pairs of legs before birth, but one pair is aborted to be again developed at the nymphal stage. This Banks regards as an indication that the six-legged larva is a secondary development, and lessens the apparent difference between Acarina and other Arachnids. In *Uropoda*, Latr., the anterior legs are inserted in the *camerostome*—the opening of the body into which the mouth parts are inserted.

*Abdomen*.—Usually large and devoid of segmentation; in some, however, segmentation is distinct. The *corpus vulva* or *epigynum* is of various shapes and sometimes closed by flaps; male aperture (*epiandrum*) usually smaller than that of the female. The reproductive system is often highly developed, and frequently occupies a considerable part of the body.

*Respiratory Organs*.—For the purpose of respiration many species are endowed with an elaborate tracheal system, but there are a large number of forms not provided with such. Amongst those species in which a tracheal system obtains, great variations are displayed. Commonly the tracheæ open near the mandibles, but with the *Ixodidæ* and *Gamasidæ* the apertures are near the hind legs. In some species the tracheal openings occur in the coxal cavities (*acetabula*). Of those—and the species are many—which have no tracheal system, it has been observed that the skin is soft, and that oxygen is absorbed by osmosis through the general surface of the body.

The object of the present paper is primarily to draw the attention of Australian students to our rich and extensive Acarid fauna. To this end a list of the known species—endemic and introduced—together with those families which may reasonably be expected to occur, is given below. Species apparently new are described.

Banks divided the larger groups of the order into eight superfamilies,<sup>6</sup> which he defined as follows:—

1. Abdomen annulate, prolonged behind; very minute forms; often with but four legs. . . . . *Demodicoidea*.
- Abdomen not annulate nor prolonged behind; always with eight legs. . . . . 2.
2. With a distinct spiracle upon a stigmal plate on each side of body (usually below) above the third or

<sup>6</sup> Banks—Proc. U. States Nat. Mus., xxviii., 1904, p. 10.

fourth coxæ or a little behind; palpi free; skin often coriaceous or leathery; tarsi often with a sucker. . . . . 3

No such distinct spiracle in a stigmal plate on this part of body. . . . . 4.

3. Hyperstome large, furnished below with many recurved teeth; venter with furrows; skin leathery; large forms, usually parasitic. . . . . *Ixodoidea*

Hyperstome small, without teeth; venter without furrows; body often with coriaceous shields, posterior margin never crenulate; no eyes. *Gamusoidea*.

4. Body usually coriaceous, with few hairs; with a specialised seta arising from a pore near each posterior corner of the cephalothorax; no eyes; mouth parts and palpi very small; ventral openings of abdomen large; never parasitic; tarsi never with a sucker. *Oribatoidea*.

Body softer, without such specialised seta. . . . . 5.

5. Living in water. . . . . *Hydrachnoidea*.

Not living in water . . . . . 6.

6. Palpi small, three-jointed, adhering for some distance to the lip; ventral suckers at genital opening or near anal opening usually present; no eyes; tarsi often end in suckers; beneath the skin on the venter are seen rod-like epimera that support the legs; body often entire; adult frequently parasitic. . . *Sarcoptoidea*.

Palpi usually of four or five joints, free: rarely with ventral suckers near genital or anal openings; eyes often present; tarsi never end in suckers; body usually divided into cephalothorax and abdomen; rod-like epimera rarely visible; adults rarely parasitic. 7.

7. Last joint of palpi never forms a "thumb" to the preceding joint; palpi simple, or rarely formed to hold prey; body with few hairs. . . *Eupodoidea*.

Last joint of palpi forms a "thumb" to the preceding, which ends in a claw (a few exceptions); body often with many hairs. . . . *Tromboidea*.

*Super-family* EUPODOIDEA.*Family* EUPODIDÆ.

No Acarids of this family have up to the present been described from Australia, but one species at least occurs. The family is a small one, and the individuals comprising it microscopic. All are predacious, and feed upon small insects or insect's eggs; one or two species are supposed to be parasitic. They are soft-bodied, delicate, with moderately long to long legs; the division of the cephalothorax and abdomen is more or less clearly defined; the cephalothorax is usually provided with two eyes—one on each side; the abdomen is provided with a few simple hairs; palpi are short, simple, four-jointed, and furnished with a few hairs; mandibles chelate, and (except in the genus *Rhagidia*, Thor.) small; legs six or seven jointed, terminating with two simple claws, and often with a median plumose pulvillus. These Acarids are fond of cold, damp places; most of the species occur upon the ground, where they may be found lurking amidst fallen leaves: some occur upon the foliage of trees.

*Genus* EREYNETES, *Berl.*ERYNETES LIMACUM, *Schr.*

*Erynetes limacum*, Schr., *Ins. Aust.*, 1781, p. 521.

*Acarus limacum*, Schr., *loc. cit.*

*Hab.*—Australia (introduced); Cosmopolitan.

*Host.*—Common European slug, *Limax maximus*, Linn. This species has followed its host in distribution. Slugs may often be seen with numbers of this Acarid swarming over them. In 1890 my colleague, Mr. C. Hedley, recorded<sup>7</sup> an Acarid as parasitic on *L. maximus* and *F. flavus*, Linn. It was doubtless the species here listed.

*Super-family* TROMBIDOIDÆ.*Family* CHEYLETIDÆ.

This is a small family, and the species constituting it are microscopic. None have, so far, been recorded from Australia, but as some are parasitic on animals that have been introduced here, it is quite likely that they may yet be recorded when the

<sup>7</sup> Hedley—*Proc. Linn. Soc. N.S. Wales*, v., (2), 1890, p. 892.

group shall have been systematically worked out. Banks points out that they differ considerably in habits and structure among themselves. Some are predacious, and some parasitic; a few occur upon some animals to prey upon the parasites of the host. The existence of parthenogenesis has been recorded in respect of several of the Cheyletidae. Banks states that "in one genus *Sarcopterus*, there is no anus; the food of this mite is of such a nature as to be completely digested."<sup>8</sup> The animals upon which Cheyletidae occur are the house and field mouse, several birds, and bats. Some live in cavities or little cells beneath the skin and hair follicles. The eggs, singly or in clusters, are attached to the hairs of the respective hosts, and some species secure their ova by spinning a small web over them.

The Cheyletidae are distinguished by their long beak and enormous palpi; the latter may be three or five-jointed; in some species each palpus is furnished with a minute movable tubercle or papilla near the tip on the inner side, and this is occasionally tipped with one or two pectinate bristles; the beak is separated from the body by a deep constriction; the body is usually oval, the skin soft, occasionally with chitinous plates, which in some species are finely striated; a few hairs are always present, sometimes in the form of scales; division between cephalothorax and abdomen usually wanting; legs generally short, five-jointed, usually armed with two claws, between which there is a bunch of hairs or a pectinate bristle. In some species the front legs terminate in bristles, which appear, according to Banks to have a tactile function; in others the front legs are transformed into clasping organs; sometimes two eyes are present—one on each side of the cephalothorax, but they are not often distinct; mandibles invariably long and needle-like, and fitted for piercing tissues; in one genus these organs are provided with two points.

#### Family TETRANYCHIDÆ.

The Tetranychidae are popularly known as "Red Spiders" and are familiar enough to most horticulturists; or are sometimes termed "spinning mites," from the fact that some of the species spin fine silken threads. Some of the species have followed their host plants, and hence have become widely distributed, indeed cosmopolitan. In the present imperfect state of our knowledge it is impossible to say how many species occur in Australia, but several have certainly been introduced. In addition to these there is little doubt but that some native

---

<sup>8</sup> Banks—*Loc. cit.*, p. 18.

species also exist. These Acarids have an oval or elliptical body with a few usually long hairs arranged in rows; the body is divided into two parts—cephalothorax and abdomen, and these are separated from each other by a transverse furrow; the cephalothorax has on each side one or two simple eyes. The palpi are short and terminate with a claw, the latter being thumb-like and bearing one or more appendages known as “fingers.” The mandibles have their basal joints united in a plate; the apical joint is long and flexible, and admirably adapted for piercing vegetable tissues, it is known as the stylet. Legs moderately slender, furnished with scattered hairs, and armed with one or two claws. In some species of the genus *Tetranychus* the claw is divided into four pieces; the body is elliptical, being one and a half times as long as broad; the first pair of legs is longer than the body.

*Genus*: BRYOBIA, Koch, = PETROBIA, Murray.

BRYOBIA PRÆTIOSA, Koch.

*Bryobia prætiosa* et *gloriosa*, Koch, Uebersicht des Arachnidensystems, 1837.

.. *speciosa*, Koch, *loc. cit.*, 1838, p. 61.

.. *nobilis*, Koch, *loc. cit.*, 1838, p. 61.

*Petrobia speciosa*, Murray, Eeon. Ent., London (no d.), p. 118.

*Bryobia speciosa*, Crawf., Rep. on the Fusicliadiuns, &c., Adelaide, 1886, p. 49, pl. iv., f. 20, *a, b, c, d, e*.

.. *ribis*, Thomas, Mt. Thur. Bot. Ver., vi., 1894, p. 10.

.. *speciosa*, Tyron, Ins. and Fungus Pests, Brisbane, 1889, p. 92.

.. *prætiosa*, Oudm., Tigds. Voor Ent., xliiii., 1900, p. 138

*Host Plants*.—Peach trees, almonds, *Arum maculatum*.

*Hab.*—South Australia (introduced): Europe.

BRYOBIA, *sp*

*Bryobia, sp.*, Tryon, Ins. and Fungus Pests, Brisbane, 1889, p. 92

*Host Plants*.—Peach trees and grape vines.

*Hab.*—Queensland.



*Obs.*—Tryon considers this form distinct from Koch's species as determined by Crawford, and although he describes it, refrains from giving it a specific name.

*Genus* TETRANYCHUS, *Duf.*

TETRANYCHUS TELARIUS, *Linn.*

*Tetranychus telarius*, Linn., Syst. Nat., x., 1758, p. 616.

*Acarus telarius*, Linn., *loc. cit.*, p. 616.

*Tetranychus telarius* (Linn.), Oliff, N. S. Wales Agric. Gaz., ii., 1891, p. 778.

*Tetranychus telarius* (Linn.), French, Journ. Agric. Vict., iv., 1906, p. 125.

*Host Plants.*—Pear, plum, cherry, roses.

*Obs.*—This pest has been frequently referred to for many years past in our public press. Doubtless several species have been confused.

*Hab.*—Albury, Cootamundra, Temora; Australia (introduced), widely distributed; Cosmopolitan.

TETRANYCHUS TELARIUS, *var. CINNABARINUS*, *Boisd.*

*Tetranychus telarius*, *var. cinnabarinus*, Boisd., Ent. Hort., 1868, p. 88.

*Hab.*—Australia (introduced).

*Obs.*—This form is peculiar to plants in conservatories. It was originally recorded as parasitic on *Dracæna australis*. Boisduval states that when it hatches from the egg "it is then green or yellowish-green; later it is variegated with black and green; after its last change of skin, it becomes a beautiful aurora red in colour. . . . It carpets the underside of the *Dracæna* with threads of silk on which it walks like a spider. It does a great deal of harm to the leaves that it sucks, stopping their vegetation and causing them to become diseased. It is not difficult to destroy them; to do so it is sufficient to place them in a cold house during two or three days."

*Hab.*—Australia (introduced).

---

<sup>9</sup> French—Journ. Agric. Vict., iv., 1906, p. 125.

TETRANYCHUS CUCUMERIS, *Boisd*

*Tetranychus cucumeris*, Boisd., Ent. Hort. 1868, p. 84

*Obs.*—Peculiar to cucumber and gherkin, but other plants are also attacked by it. It is very minute. When the Cucurbitaceæ are attacked, the weak and sickly plants should be removed.

*Hab.*—Australia (introduced).

TETRANYCHUS ROSARUM, *Boisd*

*Tetranychus rosarum*, Boisd., Ent. Hort., 1868, p. 83

*Host Plants.*—The host plant of this species is the rose, on the underside of the leaves of which it is sometimes found. This is probably the species determined by French as parasitic on roses in Victoria.

*Hab.*—Australia (introduced).

*Obs.*—Several other genera are included in this family and are probably represented in Australia, but in a preliminary study, and from lack of material systematically collected, it is impossible to define them.

## Family RHYNCHOLOPHIDÆ

These mites are usually bright red, and one of our species, at any rate, is exceedingly common on bushes around Sydney. Only one species, *Smaridia extranea*, L. Koch, has hitherto been recorded from Australia, but two additional species, each apparently referable to the genus *Rycholophus*, Dug., are described below. One of these is common enough around Sydney, but the other is from the 6000 feet level of Mount Kosciusko, where it was collected by my colleague, Mr. C. Hedley, in January last. The other form, collected by Dr. E. P. Ramsay, appears equally as abundant in winter as in summer. Both forms were taken from plants.

In the Rycholophidæ the body is usually divided into two parts, but the division is not very distinct. Along the middle of the cephalothorax there is a longitudinal furrow known as the dorsal groove or *crista*. It is usually enlarged at the anterior and posterior extremities, and sometimes at the middle. In the two Australian genera known to me there are two simple eyes on each side of the cephalothorax, but in the genus *Smaris*, Latr., two additional eyes have been recorded, and these are placed close together near the middle of the anterior margin.

Banks reports these animals as being usually found on the ground, sometimes in very hot situations, and that they run over the surface or on low plants with great rapidity. Dr. Ramsay tells me that those collected by him were always fairly active. Some individuals occur in moss or under fallen leaves. Those collected by Ramsay congregate together in larger or smaller groups, whilst the form collected by my colleague on Mount Kosciusko was solitary. Nothing is known of the habits of our indigenous species, but they will doubtless be very similar to those of their exotic congeners. Banks tells us that the eggs are deposited on the ground or under stones, often in clusters. The larva is a six-legged mite attached to insects, and when fully-fed drop to the ground, become quiescent, and after a varying time transform to the adult. One American species has been found preying on a scale insect (*Aspidiotus*): others upon the San Jose scale, and sometimes *Aphis lions* (*Chrysopa*).

*Genus SMARIDIA, Latr.*

*SMARIDIA EXTRANEA, L. Koch.*

*Smaridia extranea*, L. Koch, Verh. Zool. Bot. Ges. Wien, xvii., 1867, p. 242.

*Hab.*—Queensland.

*Genus RHYNCHOLOPHUS, Latr.*

*RHYNCHOLOPHUS MONTANUS, sp. nov.*

(Fig. 33).

Scarlet; somewhat shield-shaped; above, the animal is densely clothed with rather short bristles and hairs; junction of cephalothorax and abdomen ill-defined. *Crista*.—Full length of thorax, enlarged a little in front of posterior extremity, where there is also a small tubercle present. *Eyes*.—Four, sessile, arranged in pairs, one on each side of cephalothorax. Under-side free from bristles, but densely hairy. *Genital Opening*.—Between hind coxæ; distinct. *Legs*.—Rather short, seven-jointed, fourth pair longest; all densely clothed with long hairs. Length of body 3 mm., width 1·8 mm.

*Host Plants*.—Bushes (C. Hedley).

*Hab.*—Mount Kosciusko, at 6000 feet.

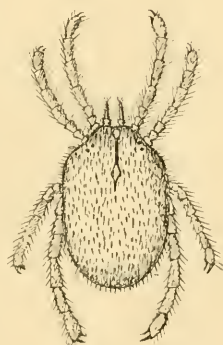

Fig. 33.

*R. montanus*, Rainb.

RHYNCHOLOPHUS CELERIPES, *sp. nov.*

(Fig. 34).

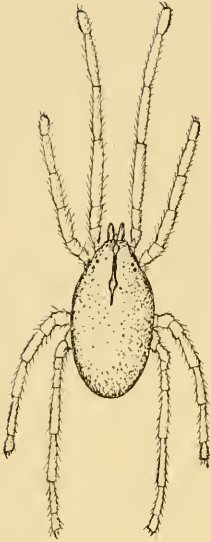

Fig. 34.

*R. celeripes*, Rainb.

Scarlet, elliptical; above, the animal is densely pilose; junction of cephalothorax and abdomen indistinct. *Crista*.—Full length of cephalothorax, deep, broadest at anterior and posterior extremities; at each extremity there is a small tubercle, and in front of the anterior one a tuft of long bristles proceeds. *Eyes*.—Four, sessile, arranged in pairs, one on each side of cephalothorax. Underside similar in colour and clothing to dorsal surface. *Genital Opening*.—Between hind coxæ, distinct. *Anal Opening*.—Below the latter, distinct. *Legs*.—Exceedingly long, seven-jointed, clothed with fine hairs and bristles, but not nearly so densely as in *R. montanus*. Length of body, 3·8 mm., width 1·8 mm.

*Host Plants*.—Bushes (E. P. Ramsay).*Hab*.—Enfield, at all seasons of the year.

## Family TROMBIDIIDÆ

This is a family of considerable extent, and includes a large number of genera. The family is an ancient one. Gourret has described two forms from the Tertiaries at Aix, France, namely, *Megameropsis aquensis* and *Pseudopachynathus maculatus*. Several species of Trombidiidæ have been recorded from New Guinea and islands close at hand, but only one from Australia. It is quite obvious, though, that others must occur, and when systematic collection has been effected it will probably be found that this branch of our native fauna will be fairly extensive.

Popularly these Acarids are known as "Harvest Mites" in the United States. The body is divided into two parts, the first of which, the cephalothorax, carries the first and second pairs of legs and the abdomen the third and fourth pairs. Banks points

out<sup>10</sup> that these mites differ from Rhyncholophidae in that the last joint of leg iv. is not or very slightly shorter than the penultimate, and also that the last joint of leg iv. is not swollen. In leg i. the last joint is usually swollen, often more so than in species of the family last quoted. They are also red in colour, though some species are darker than others; the body is clothed with bristles or feathered hairs according to the species. The palpi are five-jointed, prominent, often swollen at the middle, the penultimate joint ending in one or two claws, the last joint appearing as an appendage or "thumb" to the one preceding. Legs seven-jointed and clothed similarly to the body; tarsi terminating with two small claws. The cephalothorax has a *crista* running down the middle, and this is enlarged at the centre or posterior extremity into a triangular space known as the *areola* in which are two pores from which arise bristles. Two eyes are placed on each side of the cephalothorax, and these are frequently elevated upon long pedicels.

In the larval form, these Acarids are parasitic, and are found at times on beetles, butterflies, moths, flies, mosquitoes. Mr. G. A. Waterhouse, B.Sc., has taken the *Leptus* (or larval form) of a Trombidium from butterflies collected by him on Mt. Kosciusko. Mr. G. Goldfinch has also collected forms of *Leptus* from the common house-fly. The mature Trombidiidae feed on insects—plant lice, caterpillars and the like. In the United States one species, *Trombidium locustarum*, Riley, destroys numbers of grasshopper eggs, and in France a species has been recorded as destroying the root forms of *Phylloxera*, that scourge of the vine.

In Europe, Japan and America, the larval forms of Trombidiidae, when numerous, are sometimes known to attack man, causing intense irritation and pain, and have even been known to promote serious complications. In the United States they are known, when found upon man as "Red Bug." These larval mites burrow beneath the skin and produce inflamed spots. As Banks points out, "this is an unnatural position for the mites, and they soon die, but the waiting is not pleasant. In France these pests are known as *rouget* or *aoûtat*, and are the cause of *Erythema autumnale*; in Germany they produce *Stachelbeerkrantheit*. In England they are called "Harvest Mites" or "Gooseberry Bugs"; in Mexico, *Talsahuate*; Japan, *Akamushi*; and the West Indies, *Bête-rouge*.

---

<sup>10</sup> Banks—*Loc. cit.*, p. 30.

*Genus* TROMBIDIUM, *Fabr.*TROMBIDIUM SERICATUM, *sp. nov.*

(Fig. 35).

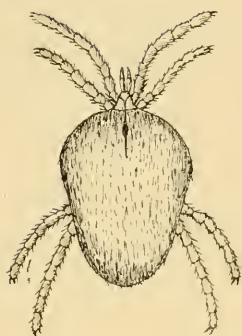

Fig. 35.

*T. sericatum*, Rainb.

Scarlet, ovate, the animal densely covered with silky pubescence, body arched, granulated; junction of cephalic and thoracic segments ill-defined. *Crista*.—Full length of cephalothorax, and enlarged at the middle into a triangular area. *Eyes*.—Four, sessile, arranged in two pairs—one on each side of the *crista*. *Abdomen*.—Much the widest in front, rounded off posteriorly. *Genital Aperture*.—Seated between the hind *coxae*, and behind the anal opening. *Legs*.—Eight, yellowish, short, stout, seven-jointed, pilose and arranged in two groups of four each, two pairs being seated well in front, the other two pairs placed near abdominal extremity. Length of body 4·5 mm., breadth 2·3 mm.

*Hab.*—Gisborne, Victoria (Mr. Geo. Lyell). Mr. A. R. McCulloch, of the Australian Museum collected specimens at Wyangarie, New South Wales.

TROMBIDIUM PAPUANUM, *Canest.*

*Trombidium papuanum*, Canest., Atti. Ist. Venet., (6), ii., 1884, p. 718, pl. iv., fig. 5.

*Host.*—"On an Australian Longicorn."

*Hab.*—Australia.

LEPTUS (*larvæ*).

*Host.*—Butterflies (Mr. G. A. Waterhouse, B.Sc.).

*Hab.*—Mt. Kosciusko, at 6000 feet.

LEPTUS (*larvæ*).

*Host.*—House-fly (Mr. G. Goldfinch).

*Hab.*—Mosman, Sydney.

LEPTUS (*larvæ*).

*Host.*—Day-flying Moth—*Procris viridipulverulenta*, Guér. (the writer).

*Hab.*—Sydney

*Obs.*—Mr. Goldfinch has also observed a *Leptus* on a moth, *Sericea spectans*, Gn.

## Super-family HYDRACHNOIDEA.

## Family HYDRACHNIDÆ.

In this family only one species, *Hydrachna odontognathus*, Canest., has been recorded from Australia, and two more are now added—*Eylais maccullochi* and *Atax cumberlandensis*. The family is extensive and widely distributed, and the species occur not only in fresh and brackish water, but also in the sea. All are free-swimming as a rule in the adult stage, but in the larval state they are parasitic. In the Hydrachnidæ, the integument is entire, there being no division between the cephalic and thoracic regions, and the body is more or less convex, spherical or broadly ovate. In some genera, as in *Arrenurus*, Dugés, the male has an elongated abdomen tipped with a median projection called the *petiolus*. In the genus *Eylais* there are four simple eyes situate close together on a plate near the median line, whilst in *Atax*, Fabr., there are only two, and these are widely separated. The integument is soft, and the animals are either scarlet or bluish-green; according to Banks, some American species are prettily marked with yellow and black, and vary considerably in maculation. The mouth-parts are often hidden under the anterior margin of the cephalothorax, and the *maxillary palpi*, consisting of four or five joints, varies so much, that it is of great value to the systematist in classification. The legs are usually of equal length, although it is not uncommon to find the first pair somewhat the longest; normally they are seven-jointed, and clothed with long hairs which aid them in swimming; in this respect the third and fourth pairs are much more densely hairy than the others.

*Genus EYLAIS, Latr.*

= *Eulais*, Piersig and Lohmann.

EYLAIS MACCULLOCHI, *sp. nov.*

(Fig. 36).

Scarlet, elliptical, strongly arched, integument smooth; mouth-parts hidden under anterior margin of cephalothorax. *Body.*—

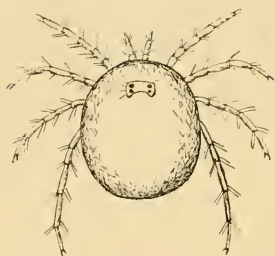

Fig. 36.

*E. maccullochi*, Rainb.

—Four, united to the venter. Length of body 3·5 mm., breadth 2·7 mm.; some specimens rather smaller.

*Hab.*—Parramatta, June, 1905, in ponds.

*Obs.*—I have named this species in honour of Mr. A. R. McCulloch, of the Australian Museum, who at my request and some personal inconvenience to himself, collected this and other material for me.

*Genus* HYDRACHNA, Mull.

HYDRACHNA ODONTOGNATHUS, Canest.

*Hydrachna odontognathus*, Canest., Atti. Ist. Venet., (6), ii., 1885, p. 719.

*Host.*—A water beetle.

*Hab.*—Australia.

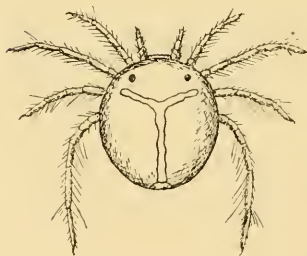

Fig. 37.

*A. cumberlandensis*, Rainb.

Entire, there being no division between the thoracic and abdominal segments. *Maxillary Palpi.*—Five-jointed, hairy. *Eyes.*—Four, simple, close together upon an eye-plate, arranged in pairs, one eye in front of the other. *Genital Opening.*—Midway between the posterior coxæ. *Legs.*—Arising close together on anterior part of venter, and in a radiate arrangement; they are not strong, but are of moderate length, and are provided with swimming hairs: the fourth pair is somewhat the longest. *Coxal or Epimeral Plates.*

*Genus* ATAX, Fab.

ATAX CUMBERLANDENSIS, *sp. nov.*

(Fig. 37).

Body bluish-green; legs green; elliptical, strongly arched, mouth-parts hidden under anterior margin of cephalothorax. *Maxillary Palpi.*—Enlarged at base, fourth joint bearing three spurs below. *Eyes.*—Two, simple, widely apart. *Body.*—Entire, integument smooth with a finely impressed median longitudinal mark, wavy in out-



line, running down the abdomen: this has two lateral branches at its anterior extremity. On the underside the colour is a little lighter than above. *Genital Opening*.—Near posterior extremity. *Sucking Discs*.—On each side, twelve. *Legs*.—Not strong, rather long; fourth pair somewhat the longest; all provided with swimming hairs. *Coxal or Epimeral Plates*.—Three, united to the venter. Length of body 1·9 mm., breadth 1·2 mm.

*Hab.*—Parramatta, in ponds, June, 1905 (Mr. A. R. McCulloch).

*Obs.*—Species of the Molluscan genus *Diplodon*, Spix, occur in fresh-water ponds around Parramatta, and they are frequently infested with Acarids. The latter, however, are scarcely parasitic, as they feed on minute animals drawn in by the mollusc.

#### Family HALACARIDÆ

Several species of Halacaridæ have been recorded from Australia and adjacent islands, and as all of these are pelagic, it is only natural to expect such forms (or at any rate, some of them) to have a wide geographical range. Those occurring on the shores of New Guinea and the North Island of New Zealand, for instance, may certainly be expected to occur here. These Acarids are minute, ranging from one to two millimetres in length. They are found upon Algae, Corals, Crustaceans and Chitons, often in shallow water, although some have been dredged at considerable depths. Halacarids have a tough skin, which may be striated or granulated, and most frequently destitute of hairs or bristles. The body is usually clearly divided into two parts, and the cephalothorax has usually three eye-spots—one on each side and one at the middle in front. Legs are moderately long, rather widely separated at the base, and lateral or sub-lateral in origin. Each tarsus terminates with two claws. Some Halacaridæ occur in fresh water, and some in brackish.

#### Genus AGAUE, Lohm

##### AGAUE BREVIPALPUS, Troues.

*Agauë brevipalpus*, Troues., *Naturaliste*, xi., 1889, p. 181; *Bull. Sci. France Belgique*, xx., 1889, p. 247; Lohmann in *Ergeb. Plankton Exped.*, ii., 1893, p. 87; Trouessart, *Bull. Soc. Zool. France*, xxv., 1900, p. 47.

*Hosts*.—Algae and Corals

*Hab.*—Pacific Ocean, Sydney, New South Wales; also Mediterranean Sea; Atlantic Ocean; Azores, Canaries, Bermudas, Brazil.

*Genus HALACARUS, Gosse*HALACARUS (POLYMELA) HISPIDUS, *Lohm*

*Halacarus (Polymela) hispidus*, Lohm., *Ergeb. Plankton Exped.*, ii., 1893, p. 71, pl. iii., f. 7, 9-11.

*Host.*—Algæ.

*Hab.*—Pacific Ocean, Sydney.

HALACARUS (POLYMELA) PANOPÆ, *Lohm*

*Halacarus (Polymela) panopæ*, Lohm., *Ergeb. Plankton Exped.*, ii., 1893, p. 72, pl. iii., f. 1, 8, pl. iv., f. 8, 9.

*Host.*—Algæ

*Hab.*—Pacific Ocean, Sydney ; Atlantic Ocean, Cape Verd.

HALACARUS (POLYMELA) PANOPÆ, *var. squamifera, Lohm.*

*Halacarus (Polymela) panopæ*, *var. squamifera*, Lohm., *Ergeb. Plankton Exped.*, ii., 1893, p. 73.

*Host.*—Algæ.

*Hab.*—Pacific Ocean, Sydney ; Atlantic Ocean, mouth of the Amazon River.

HALACARUS (POLYMELA) CHEVREUXI, *Troues.*

*Halacarus (Polymela) chevreuxi*, Troues., *Naturaliste*, (3), xi., 1889, p. 162 ; *Bull. Sci. France Belgique*, xx., 1889, p. 245 ; Lohman, *Ergeb. Plankton Exped.*, ii., 1893, p. 73, pl. iv., f. 3-7, 10, 11, text fig. 6 ; Trouessart, *Bull. Soc. Zool. France*, xxv., 1900, p. 46.

*Hosts.*—Algæ and Corals.

*Hab.*—Pacific Ocean, Sydney, Chili ; Atlantic Ocean, Azores, Canaries ; Mediterranean Sea.

HALACARUS OBLONGUS, *Lohm.*

*Halacarus oblongus*, Lohm., *Ergeb. Plankton Exped.*, ii., 1893, p. 83, pl. ix., f. 1, 3, pl. x., f. 3, 7, text fig. 9.

*Hosts.*—Ascidians and Aleyonarians.

*Hab.*—Pacific Ocean, Sydney.

HALACARUS (COPIDOGNATHUS) LAMELLOSUS, *Lohm.*

*Halacarus (Copidognathus) lamellosus*, Lohm., *Ergeb. Plankton Exped.*, ii., 1893, p. 79, pl. vi., f. 1-9, pl. vii., f. 1, 4.

*Hosts.*—Algae and stationary animals.

*Hab.*—Pacific Ocean, Sydney; Atlantic Ocean, Bermudas and mouth of the Amazon.

HALACARUS (COPIDOGNATHUS) PULCHER, *Lohm.*

*Halacarus (Copidognathus) pulcher*, Lohm., *Ergeb. Plankton Exped.*, ii., 1893, p. 77, pl. v., f. 1-8, text fig. 7.

*Host.*—Algae.

*Hab.*—Pacific Ocean, Sydney; Atlantic Ocean, Bermudas and Ascension.

*Super-family* IXODOIDEA.

The Ixodoidea embrace by far the best known of all the Acarids, and are popularly termed ticks. They form a perfectly natural group, the members of which may be easily known by their general appearance and size, for none are so small that they may not be seen by the naked eye. All are parasitic, their hosts including sometimes man, various mammals, birds and reptiles. Their integument is coriaceous; the females are much larger than the males, and their bodies capable of considerable distension. Before distension they are somewhat triangular in outline, rather flat, with prominent, slender legs, and the beak-like rostrum in front. Of our Australian tick acquaintances some are indigenous, and some introduced—the latter which includes the Cattle Tick, *Rhipicephalus annulatus*, Say., being by far the most serious.

## Family ARGASIDÆ

Genus ARGAS, *Latr*

ARGAS REFLEXUS, *Fab.*

*Argas reflexus*, *Fab.*, *Ent. Syst.*, iv., 1794, p. 426.

*Acarus reflexus*, *Fab.*, *loc. cit.*

*Argas reflexus*, *Latr.*, *Précis des Car. gen. des Ins.*, 1796, p. 178, an v.

*Rhynchoprion columbae*, *Mém. Aptérologique* Strasbourg, 1804, p. 69.

*Argas reflexus*, Neum., Mém. Soc. Zool. France, ix., 1896, pp. 4-6, f. 1-3.

*Hosts*.—Pigeons, fowls. Starcovici reported that he has seen the larvæ on the horse in Roumania.

*Hab*.—Europe (widely distributed). Australia (introduced).

ARGAS PERSICUS, *Fischer de Waldheim*.

*Argas persicus*, Fischer de Waldheim, Bull. Acad. Sci. Moscou, 1823.

*Argas persecus*, Laboulbène and P. Mégnin, Journ. l'anat. et de la physiol., xviii., 1882, p. 317, pl. xxi.-xxiii.

*Argas persecus*, Michael, Nat. Sci., May, 1892, p. 202; N.S.W. Agric. Gaz., vii., 1896, p. 593; and *ibid.*, xii., 1901, p. 1349.

*Argas persicus*, Neum., Mém. Soc. Zool. France, ix., 1896, pp. 7-9, f. 4, 5.

*Hosts*.—Human beings and probably domestic fowls.

*Hab*.—N. W. and N. E. Persia, from whence it appears to have spread into Europe; Adelaide, S.A. (introduced).

ARGAS AMERICANUS, *Packard*.

*Argas americanus*, Packard, *Arachnida*, U. S. Geol. Survey, 1872, p. 740, fig. 68.

*Argas americanus*, Frogg., N.S.W. Agric. Gaz., ix., 1898, p. 975; *ibid.*, xi., 1901, p. 542; *ibid.*, xii., 1901, pp. 1285 and 1349, pl.

*Argas americanus*, Neum., Mém. Soc. Zool. France, ix., 1896, pp. 9-12, f. 6-11.

*Argas americana*, Brown, Journ. Agric. Vict., i., 1902, pp. 86-90 and 209-216.

*Hosts*.—Domestic fowls and turkeys.

*Hab*.—America; Australia (widely distributed; introduced).

ARGAS SP.

*Argas sp.*, Fuller, N.S.W. Agric. Gaz., vii., 1896, p. 590, f. 1-4.

*Hosts*.—Domestic fowls.

*Hab*.—New South Wales.

## Family IXODIDÆ.

## Tribus A: RHIPICEPHALÆ.

## Genus HÆMAPHYSALIS, Koch.

= *Rhipistoma*, Koch; *Gonixodes*, Dugés; *Opistodon*, Canestrini.

## HÆMAPHYSALIS PAPUANA, Thor.

*Hæmaphysalis papuana*, Thor., Ann. del Mus. civ. di St. Nat. di Genova, xviii., 1882, p. 62, pl. vi., f. 40-45.

*Hæmaphysalis papuana*, Neum., Mém. Soc. Zool. France, x., 1897, p. 336, 337.

*Hosts*.—Not known. Canestrini found two examples, 1 ♂ 1 ♀, attached to a strip of skin from some mammal, in cotton which had been used for packing some insects and reptiles from Australia (Queensland).

*Hab*.—New Guinea (Ramoï), and Queensland.

## HÆMAPHYSALIS LEACHI, Aud.

*Hæmaphysalis leachi*, Aud., Description de l'Égypte, 2nd ed., xxii., 1827; Zoologie, *Explic. des planches*, p. 428.

*Rhipistoma leachi*, C. L. Koch, Archiv für Naturgeschichte, (1), x., 1844, p. 239.

*Rhipistoma ellipticum*, C. L. Koch, *loc. cit.*

*Rhipicephalus ellipticus*, C. L. Koch, Uebersicht des Arachniden-systems, iv., 1847, p. 135, pl. xxx., fig. 111.

*Rhipidostoma leachi*, Karsch, Monatsbericht K. Akad. Wis. Berlin, 1878, p. 337.

*Hæmaphysalis leachi*, Neum., Mém. Soc. Zool. France, x., 1897, p. 347-350, f. 13-15; *loc. cit.*, xiv., 1901, p. 263.

*Hæmaphysalis leachi*, Frogg., N.S.W. Agric. Gaz., xi., 1900, p. 542.

*Hosts*.—In Eastern Ethiopia, *Felis pardus*, Linn. (leopard); cattle and horses at Grafton and Wallangra, N.S.W.

*Hab*.—Widely distributed over the African continent; Narrabri and Kempsey, N. S. Wales (introduced).

## HÆMAPHYSALIS LONGICORNIS, Neum.

*Hæmaphysalis longicornis*, Neum., Mém. Soc. Zool. France, xiv., 1901, p. 261, f. 2.

*Hosts*.—Cattle.

*Hab*.—Narrabri and Kempsey, N. S. Wales.

*Genus* RHIPICEPHALUS, Koch.

= *Acarus* (in part), Linn.; *Ixodes* (in part), Latr.; *Phauloixodes* Berl.; *Boophilus*, Curt.

## RHIPICEPHALUS ANNULATUS, Say.

*Rhipicephalus annulatus* Say, Journ. Acad. Nat. Sci. Phil., ii. 1821, p. 75.

*Hæmaphysalis rosea*, Koch, Archiv. f. Naturgesch., (1), x., 1844 p. 237; Uebersicht des Arachnidensystems, iv, 1847, p. 121 pl. xxvi., fig. 95 ♂, fig. 97 ♀.

*Ixodes bovis*, Riley, In Rep. on Diseases of Cattle by Gamgee, U.S. Dept. Agric., Special Rep., 1869.

*Ixodes bovis*, Fuller, Agric. Gaz. N.S.W., vii., 1896, p. 765, pls. i-iv., text figs.

*Ixodes identatus*, Gamgee, Rep. Diseases of Cattle, U.S. Dept. Agric., Special Rep., 1869.

*Ixodes dugesii*, Mégnin, Les Parasites et les Maladies Parasitaires, Paris, 1880.

*Hæmaphysalis micropola*, Canest., Atti. della Soc. Veneto Trentina Sci. nat., xi, fasc. 1, 1887, p. 104, pl. ix., f. 3 and 5.

*Boophilus bovis*, Curt., Washington Biolog. Soc., 1890; *loc. cit.*, 1891; Journ. Compar. Med. and Vet. Archives, 1892, p. 1; Bull. Texas Agric. Exper. Sta., No. 24, 1892; N.S.W. Agric. Gaz. (reprint), vii., 1896, p. 454, pls. 1-3.

*Boophilus (Ixodes) bovis*, Fuller, N.S.W. Agric. Gaz., vii., 1896, p. 451, two text figs.

*Rhipicephalus calcaratus*, Birula, Bull. Acad. Imp. Sci. St. Pétersbourg, No. 4, 1895, p. 361, pl. ii., f. 10-20.

*Rhipicephalus annulatus*, Rainb., Rec. Aust. Mus., iii., 1899, p. 131.

*Rhipicephalus annulatus*, Frogg., N.S.W. Agric. Gaz., xi., 1900, p. 542.

*Rhipicephalus annulatus*, Neum., Mém. Soc. Zool. France, x., 1897, p. 407, f. 37-42; *loc. cit.*, xiv., 1901, p. 276.

*Hosts*.—The hosts of this, now cosmopolitan, species are as follows:—In Texas, Maryland, Washington, Chicago, Baltimore, Kentucky, Kansas, Arkansas, New Mexico and Honduras: cattle; Cuba: cattle and dogs; Jamaica: cattle; Florida: Deer (*Cariacus virginianus*, Bodd.); Guadeloupe, where it is known as the "Creole Tick": cattle; Paragnay: under the bark of trees; Timor: "Sambar" deer (*Rusa equinus*, Cuvier); Caucasus and Transcaucasus of Asia, Singapore: cattle; Algiers and Morocco: cattle; Barbary and Touarick: sheep.

*Hab*.—Cosmopolitan.

## RHIPICEPHALUS ANNULATUS, var. AUSTRALIS, Neum.

*Rhipicephalus annulatus*, var. *australis*, Neum., Mém. Soc. Zool. France, xiv., 1901, p. 280.

*Rhipicephalus annulatus*, var. *australis*, Frogg., N.S.W. Agric. Gaz., xi., 1900, p. 542.

*Hosts*.—Cattle (Queensland Cattle Tick).

*Hab*.—Queensland.

## Tribus B: IXODÆ.

## Genus IXODES, Latr.

= *Acarus* (in part), Linn.; *Cynorhæstes* (in part), Herm.; *Crototus* (in part), Dum.

## IXODES ORNITHORHYNCHI, Lucas.

*Ixodes ornithorhynchi*, Lucas, Ann. Soc. Entom. France, (2), iv., 1845, p. 58, pl. i., f. 3.

*Ixodes ornithorhynchi*, Neum., Mém. Soc. Zool. France, xii., 1899, p. 142, f. 18, 19.

*Host*.—*Ornithoryctes anatinus*, Shaw.

*Hab*.—Tasmania; also Marianne Isles, Micronesia (Monotreme recorded as host does not occur here).

## IXODES TASMANI, Neum

*Ixodes tasmani*, Neum., Mém. Soc. Zool. France, xii., 1899, p. 144, f. 20.

*Host*.—Not known.

*Hab*.—Tasmania; Is. of St. Pierre, Gt. Australian Bight.

## IXODES HOLOCYCLUS, Neum.

*Ixodes holocyclus*, Neum., Mém. Soc. Zool. France, xii., 1899, p. 151, f. 24-26.

*Ixodes holocyclus*, Frogg., N.S.W. Agric. Gaz., xi., 1900, p. 541.

*Hosts*.—Man, dog. Commonly known as "Bush" or "Dog" Tick. Froggatt quotes it as infesting low shrubs, one in particular—*Kunzia capitata*, Reichb.—has been called "Tick Bush" on this account. This tick is also recorded by Neumann as occurring on the Brush-tailed Pouch Mouse—*Phascogale peri-*

*cillata*, Shaw; the red squirrel of India, and another squirrel *Sciurus variabilis*, Geoff. The locality for the latter animal is given as India, but according to Trouessart ("Catalogus Mammalium") the habitat should be South and Central America.

*Hab.*—New South Wales, Queensland, India (?), S. and C. America (?).

Genus APONOMMA, Neum.

= *Ixodes*, Latr. (in part); *Ophiodes*, Murray (*nom. præoc.*).

APONOMMA TRIMACULATUM, Lucas.

*Aponomma trimaculatum*, Lucas, Ann. Soc. Ent. France, (5), viii., 1878, p. lxxvii.

*Ixodes trimaculatus*, Lucas, *loc. cit.*

*Aponomma trimaculatum*, Neum., Mém. Soc. Zool. France, xii., 1899, p. 187, f. 41; *loc. cit.*, xiv., 1901, p. 291.

*Aponomma trimaculatum*, Frogg., N.S.W. Agric. Gaz., xi., 1900, p. 542.

*Hosts.*—Cattle; Lace Lizards: *Varanus leucostigma* (*sic*) and *V. salvator*, Laur.

*Hab.*—New Guinea (or Guinea, *fide* Neumann); Palang, Sumatra; and Narrabri, N. S. Wales.

APONOMMA DECOROSUM, L. Koch.

*Aponomma decorosum*, L. Koch, Verhand. b. Ges. Wien., xvii., 1867, p. 241.

*Ixodes decorosus*, L. Koch, *loc. cit.*

*Ixodes varani*, L. Koch, *loc. cit.*

*Aponomma decorosum*, Neum., Mém. Soc. Zool. France, xii., 1899, p. 194, f. 46-48.

*Aponomma decorosum*, Frogg., N.S.W. Agric. Gaz., xi., 1900, p. 541.

*Aponomma decorosum*, Neum., Mém. Soc. Zool. France, xiv., 1901, p. 292, f. 9.

*Hosts.*—Lizards: *Varanus giganteus*, Gray; *Varanus sp.*: *V. varius*, Gray; Snakes: *Python sp.*: the Echidna: *Tachyglossus aculeatus*, Shaw.

*Hab.*—Australia: Brisbane, Sydney, Goulburn; Fiji.



APONOMMA HYDROSAURI, *Denny.*

*Aponomma hydrosauri*, Denny, Ann. Mag. Nat. Hist., xii., 1843, p. 314, pl. xvii., f. 4.

*Ixodes hydrosauri*, Denny, *loc. cit.*

*Anblyomma hydrosauri*, Koch, Archiv. f. Naturg., x., (1), 1844, p. 231.

*Aponomma hydrosauri*, Neum., Mém. Soc. Zool. France, xii., 1899, p. 197, f. 49, 50.

*Aponomma hydrosauri*, Frogg., N.S.W. Agric. Gaz., xi., 1900, p. 541.

*Hosts.*—Lizards: *Varanus varius*, Gray; *V. gouldi*, Gray; Echidna: *Tachyglossus aculeatus*, Shaw.

*Hab.*—Australia and Tasmania.

APONOMMA CONCOLOR, *Neum.*

*Aponomma concolor*, Neum., Mém. Soc. Zool. France, xii., 1899, p. 198.

*Host.*—Echidna: *Tachyglossus aculeatus*, Shaw.

*Hab.*—Queensland.

*Obs.*—Neumann adds a note to his description, of which the following is a translation: "Founded on an individual labelled '*Ixodes coxalis*, Gerv., ♂, on a *Hystrix*, Queensland,' and which only corresponds in its habits with *Ix. coxalis*, Gervais, which latter is probably a *Dermacentor*."

APONOMMA ECINCTUM, *Neum.*

*Aponomma ecinctum*, Neum., Mém. Soc. Zool. France, xiv., 1901, p. 293.

*Aponomma ecinctum*, Frogg., N.S.W. Agric. Gaz., xi., 1900, p. 542.

*Hosts.*—Beetles: *Aulacocylus kaupi*, Macl.

*Hab.*—Queensland, New South Wales. It will also occur, doubtless, in other States.

*Genus* AMBLYOMMA, *C. L. Koch.*

= *Ixodes* (in part), Latr.

AMBLYOMMA TRIGUTTATUM, *C. L. Koch.*

*Amblyomma triguttatum*, *C. L. Koch*, Archiv. f. Naturg., (1), x., 1844, p. 255; Arachnidssystem, iv., 1847, p. 60, pl. ix., f. 33.

*Amblyomma triguttatum*, *Neum.*, Mém. Soc. Zool. France, xii., 1899, p. 215.

*Amblyomma triguttatum*, *Frogg.*, N.S.W. Agric. Gaz., xi., 1900, p. 541.

*Amblyomma triguttatum*, *Neum.*, Mém. Soc. Zool. France, xiv., 1901, p. 298.

*Hosts.*—Horses, cattle, dogs; the "Paddy-melon," *Macropus thetidis*, *Lesson*; and the Echidna, *Tachyglossus aculeatus*, *Shaw*.

*Hab.*—N. S. Wales and Queensland.

AMBLYOMMA LIMBATUM, *Neum.*

*Amblyomma limbatum*, *Neum.*, Mém. Soc. Zool. France, xii., 1899, p. 231.

*Host.*—Not indicated.

*Hab.*—King Island, Bass Straits; Adelaide.

*Obs.*—*Neumann* thinks this may probably be a variety of *A. moreliæ*, *L. Koch*.

AMBLYOMMA POSTOCULATUM, *Neum.*

*Amblyomma postoculatum*, *Neum.*, Mém. Soc. Zool. France, xii., 1899, p. 232.

*Host.*—Not indicated.

*Hab.*—King Island, Bass Straits; Adelaide.

AMBLYOMMA MORELIÆ, *L. Koch*

*Amblyomma moreliæ*, *L. Koch*, Verhandl. K. zool. bot. Ges. Wien., xvii., 1867, p. 241.

*Amblyomma moreletii*, Neum., Mém. Zool. France, xii., 1899, p. 258.

*Amblyomma moreletii*, Frogg., N.S.W. Agric. Gaz., xi., 1900, p. 541.

*Hosts*.—Horses, Kangaroos, and Carpet Snake, *Python spilotes*, Lacép

*Hab*.—N. S. Wales and Queensland.

### *Super-family* GAMASOIDEA.

The species included in this super-family are well-known to collectors, not only from the fact that many are common, but also because many pass a portion of their life attached to spiders, myriapods, and insects. These mites have, as a rule, a hard, leathery integument; some, however, are soft-bodied; they are broad, flat, short-legged, devoid of eyes, but exceedingly sensitive in point of touch; some of these mites can run rapidly, and leap, while others are lethargic, and seek protection when disturbed by feigning death. In some species the mouth-parts can be completely withdrawn into the body. Normally the mandibles are chelate, and the "fingers" denticulated. Examples occur in which these organs are elongate and styliform, and hence adapted for piercing.

#### *Family* GAMASIDÆ.

This is an extensive family, of world-wide distribution, and including many genera and species. And here, again, in working over literature, the student is brought face to face with the fact that more species have been described and recorded from New Guinea than from Australia. Doubtless some of the Papuan forms will, when the subject is properly worked, be found to occur upon our island continent. For a description of the internal anatomy of the Gamasidæ, and a description of their mode of coition, which latter is marvellous, and doubtless unique in nature, see Michael's paper "On the Variations in the Internal Anatomy of the Gamasinæ."<sup>11</sup> Species of Gamasidæ have been recorded not only from Arthropods, but also from the ears of cattle and horses and from the bodies of moles, and nests of the latter; some have been recorded as living on mosses and various plants. Amongst insects infested with these mites are beetles,

<sup>11</sup> Michael—Trans. Linn. Soc., v., pt. 8, 1892, p. 281, *et seq.*

bees and ants; some Gamasids feed upon the dead bodies of the latter. A species of *Lalaps* has been observed to jump upon an ant and ride about on it, without in any way disconcerting the Formicid. Each species of mite is said to prefer to live with a particular species of ant, although several kinds have been found in one nest. When the ants quit the nest the mites disappear also. Protonymphs have been collected from plants, and deutonymphs and tritonymphs from meals—flour, etc.—and houses.

*Genus* CELÆNOPSIS, *Kram.*

A number of mites from various parts of the world, including one from Australia, have been associated with Koch's genus *Celæno*, which was founded in 1835. This name, however, cannot stand for the Arachnida, as it was preoccupied for the Mammalia, Leach having in 1822 proposed *Celæno* for a bat. For the present, therefore, I suggest that as *Celæno*, Koch, has to sink into the ranks of synonymy, Kramer's *Celænopsis* be used instead.

CELÆNOPSIS AUSTRALIANA, *Canest.*

*Celænopsis australiana*, Canest., Atti. Ist. Venet., (6), ii., 1885, p. 715, pl. vi., fig. 2.

*Host.*—Beetles—type found upon a Cetonid.

*Hab.*—Australia.

*Genus* LÆLAPS, *Koch.*

LÆLAPS DOLIC[H]ANTHUS, *Canest.*

*Lalaps dolic[h]anthus*, Canest., Atti. Ist. Venet., (6), ii., 1885, p. 709, pl. vii., f. 2 and 3.

*Host.*—Beetles—type found upon a Lamelicorn. We have in our collection, specimens probably referable to this species, from beetles and spiders collected by Mr. S. J. H. Moreau, at Antonio, near Rydal, N. S. Wales.

*Hab.*—Australia.

LÆLAPS CONIFERUS, *Canest.*

*Lalaps coniferus*, Canest., Atti. Ist. Venet., (6), ii., 1885, p. 711, pl. vii., f. 4.

*Host.*—Beetles—type found upon a Longicorn.

*Hab.*—Australia.

*LÆLAPS STILOSUS, Canest.*

*Laelaps stilosus*, Canest., Atti. Ist. Venet., (6), ii., 1885, p. 711,  
pl. ix., f. 3.

*Host.*—Beetles—type found upon a Longicorn.

*Hab.*—Australia.

*Genus SEIUS, Koch.*

Species of this genus have been recorded as occurring upon moss, and in caves; and protonymphs upon plants. Only one species has, so far, been described from Australia.

*SEIUS ACANTHURUS, Canest.*

*Seius acanthurus*, Canest., Atti. Ist. Venet., (6), ii., 1885, p. 712,  
pl. ix., f. 1 and 2.

*Hab.*—Australia.

*Genus GAMASUS, Latr.**GAMASUS FLAVOLIMBATUS, L. Koch.*

*Gamasus flavolimbatus*, L. Koch, Verhandl. K. zool. bot. Ges.  
Wien, 1867, p. 242.

*Hab.*—Queensland.

*Genus BERLESIA, Canest.**BERLESIA RAPAX, Canest.*

*Berlesia rapax*, Canest., Atti. Ist. Venet., (6), ii., 1885, p. 714,  
pl. ix., f. 4.

*Hab.*—Australia.

*Family DERMANYSSIDÆ.*

The mites included in this family are soft-skinned, and parasitic on warm-blooded animals. Banks considers that whilst these Acarids differ much in general appearance from the Gamasidæ, to which they are closely allied by structure, it would nevertheless be better to abandon the group. The best character for separa-

tion from the Gamasidæ is their parasitic habits.<sup>12</sup> The family, as at present constituted, is divided into two sub-families, the Dermanyssinæ and Halarachniniæ, and they are distinguished from one another by, in the first of these, the presence of an anal plate, and in the latter, the absence thereof.

These mites are parasitic on bats, mice, rats and birds, and some of them have followed their hosts in their travels from place to place, and so have become not only widely distributed, but in some instances, cosmopolitan. Two species of *Dermanyssus* have found a home in many lands, and they are recorded below as parasitic on domestic birds. By the uninformed they are frequently confused with Bird Lice. Other forms doubtless occur, but none have been described from Australia.

*Genus* DERMANYSSUS, *Dugés*.

DERMANYSSUS GALLINÆ, *De Geer*.

*Dermanyssus gallinæ*, De Geer, *Mém. Inst.*, vii., 1778, p. 11.

*Acarus gallinæ*, De Geer, *loc. cit.*

*Dermanyssus gallinæ*, Oudem., *Tidjs. Voor Entom.*, xlv., 1902, p. 13, pl. i., f. 2, 3.

*Hosts*.—Domestic fowls.

*Hab*.—Cosmopolitan ; Australia (introduced).

DERMANYSSUS AVIUM, *Dugés*.

*Dermanyssus avium*, Dugés, *Ann. Sci. Nat.*, (2), i., 1834, p. 18.

*Dermanyssus avium*, Murray, *Econom. Entom.* (n. d.), p. 169, 2 f. in text.

*Hosts*.—Pigeons, canaries, domestic fowls.

*Hab*.—Cosmopolitan ; Australia (introduced).

*Obs*.—This species has been recorded as occurring on human beings, but it was accidental, and due to the individuals coming into contact with infested birds. It is also recorded that the removal of an infested henroost resulted in the cure of a case of supposed plithiriasis. The subject, a woman, was, but for these pests, clean and healthy.

<sup>12</sup> Banks—*Loc. cit.*, p. 59.

*Family* UROPODIDÆ.

The Uropodidæ are distinct from the two preceding families in general appearance. The mites are small. They are usually found attached to insects, and are remarkable for the length of their mandibles, which are often twice as long as the body, slender, and terminating in delicate chelæ. They are not, strictly speaking, parasitic, their presence upon insects being for the purpose of transportation; moreover, those found upon insects, are attached by a pedicel of excrement, and owing to the fact that they are immature, have been termed *nympha pedunculata*. Up to the present two species have been described from Australia.

*Genus* UROPODA, Latr.

## UROPODA SPINULIPES, Canest.

*Uropoda spinulipes*, Canest., Atti. Ist. Venet., (6), ii., 1885, p. 714.

*Hab.*—Australia (on a Geotrupid).

*Genus* FEDRIZZIA, Canest.

## FEDRIZZIA GROSSIPES, Canest.

*Fedrizzia grossipes*, Canest., Atti. Ist. Venet., (6), ii., 1885, p. 707, pl. viii., f. 1 and 2.

*Hab.*—Australia (on a Geotrupid).

*Super-family* ORIBATOIDEA.

The Acarids included in this group are popularly known as "Beetle Mites." They are small and hard; some have rather short legs, and others extremely long ambulatory limbs. Superficially, these mites have a very beetle-like appearance, and this is doubtless the origin of the popular name. Oribatids may be easily distinguished from all other Acarids by the presence of a hair or *seta* which is seated on either side of the cephalothorax, and this arises from a small pore. These are usually termed *pseudo-stigmata*, and their function is unknown. The super-family under consideration is an extensive one and widely distributed. The species occur on dead wood, lichens, in moss, amongst dead leaves and forest debris generally: some are aquatic, occurring in mangrove swamps and on fresh-water and marine Algæ; a few species are amphibious. These Acarids

are never parasitic, but are vegetable feeders. Usually they are oviparous, sometimes ovo-viviparous, and rarely viviparous. When the young emerge they have only three pairs of legs, but in the next stage they have four; two other changes or *ecdyses* occur, however, before the adult stage is attained. About twenty genera are included in the Oribatoidea, and these include many species, but the group has not been touched in Australia, notwithstanding the fact that quite a number of species occur, and some are stored away in private collections. I have seen specimens from the Jenolan District. In 1897 Canestrini described several from German New Guinea. Tryon has recorded one under the name *Leisoma*, *sp.*, from Durundur, Q., but this is the only reference I can find.

*Family* ORIBATIDÆ.

*Genus* LIACARUS, *Michael*.

= *Leisoma*, Nicolet (*nom. præoc.*).

LIACARUS *sp.*, *Tryon*.

*Liacarus sp.*, Tryon, *Insect and Fungus Pests*, 1889, p. 160.

*Leisoma sp.*, Tryon, *loc. cit.*

*Hab.*—Durundur, Queensland

*Family* TARSONEMIDÆ.

There are not many genera or species included in this family, but some forms are of the highest economic importance. These Acarids are exceedingly minute—in fact microscopic. All the species are parasitic—some on vegetation, some on cereals, such as grasses, rice and grain, and some on insects; one species has been found upon a mole. In Queensland, pine-apples and sugarcane are affected. The Tarsonemidæ are soft-bodied mites, the males conforming somewhat to the Tyroglyphid type; but the females differ not only from them, but from all other Acarians in having a clavate organ of uncertain use between legs i. and ii.<sup>13</sup> The mouth-parts are formed for sucking; mandibles slender and needle-like; palpi minute, barely visible; legs short and composed of five or six joints; anterior tarsi always terminated with one claw, the others have usually two and often a sucker; the posterior pairs of legs are widely remote from anterior pairs; in

---

<sup>13</sup> Banks—*Loc. cit.*, p. 74.



the males of *Tarsonemus* they are almost at the tip of the abdomen; in some species the abdomen shows traces of segmentation. One species of *Pediculoides* and two of *Tarsonemus* have been recorded from Australia.

Genus *PEDICULOIDES*, *Targioni-Tozzetti*.

= *Heteropus*, Pal.

*PEDICULOIDES ALASTORIS*, *Frogg.*

*Pediculoides alastoris*, Frogg., Proc. Linn. Soc. N. S. Wales, ix., (2), 1894, p. 259.

*Heteropus alastoris*, Frogg., *loc. cit.*

*Host*.—*Alastor eriurgus*, Sauss. (a solitary wasp).

*Hab*.—Granville, N. S. Wales.

*Obs*.—Some exotic species of this genus are parasitic on destructive insects. In the gravid female the abdomen swells prodigiously. This is due to the development of the eggs. These not only hatch within the parent, but the young obtain their entire nourishment there, and issue as sexually mature males and females. The new brood usually wander for a time over the mother's body and then pair. Banks figures a normal and a gravid female.<sup>14</sup>

Genus *TARSONEMUS*, *Cuñest.*

*TARSONEMUS BANCROFTI*, *Mich. (m.s.)*

*Tarsonemus bancrofti*, Mich. (m.s.), Bull. Roy. Gardens Kew, 1890, p. 85.

*Tarsonemus bancrofti*, Insect Life, iii., 1890, p. 31.

*Tarsonemus bancrofti*, March., Bull. Soc. Ent. France, 1902, pp. 103, 104.

*Tarsonemus bancrofti*, Banks, Proc. U. States Nat. Mus., xxviii., 1904, p. 77

*Host Plant*—Sugar canes, *Saccharum officinarum*.

*Hab*.—Queensland and Barbadoes.

*Obs*.—*T. bancrofti*, Michael, is associated with the sugar-cane disease known in Queensland as "Red Rust." This disease has been long established in Queensland, Dr. Bancroft having in

<sup>14</sup> Banks—*Loc. cit.*, pp. 74, 75. f. 144, 146.

1876 reported the matter to Parliament. In a "Bulletin of the Royal Gardens, Kew,"<sup>15</sup> I read as follows: "It appears not improbable that the disease is identical with one which has been noted in the Malayan Archipelago, and in the Mauritius,<sup>16</sup> in the Society Islands according to Professor Liversidge, and in Bahia."

*TARSONEMUS ANANAS, Tryon.*

*Tarsonemus ananas*, Tryon, Queensl. Agric. Journ., iii., pt. 6, 1898, pp. 462-464, pl. lxxi., f. 1, 2, 5, 6.

*Tarsonemus anasa*, Banks, Proc. U. States Nat. Mus., xxviii., 1904, p. 77.

*Host Plant*.—Pine apples (*Ananasa* sp.).

*Hab.*—S. Queensland.

*Family TYROGLYPHIDÆ.*

This is another small family of mites, yet notwithstanding, one of great economic importance, seeing that it embraces species notorious by reason of their infesting foods—cheese, cereals, tubers, bulbs; some are also found attached to living mammals and insects during what is termed the hypopial stage. For species in this stage three genera were proposed on the supposition that they were adult Acarids. These were *Hypopus*, Dugés, *Homopus*, Koch, and *Trichodactylus*, Duf. Mègnin<sup>17</sup> made lengthy observations on the zoological position and economy of Acarids described under these generic names, and showed that they were all earlier stages of certain Tyroglyphidæ. The two latter names were therefore dropped, whilst the first was retained and is still used as a name to distinguish these Acarids at a certain stage of their development—the "nymphé cuirassée, adventive, hétéromorphe."

Tyroglyphid mites are very small, pale-coloured, very soft, and have usually prominent chelate mandibles and moderately long legs, the tarsi terminating with one claw; the body is about twice as long as broad. The adults are certainly blind, but in some hypopial forms there are organs which have never been satisfactorily defined and which may possibly be eyes. The division between the cephalothorax and abdomen is invariably

<sup>15</sup> Michael—Bull. Roy. Gardens Kew, 1890, p. 86.

<sup>16</sup> Liversidge—Journ. Roy. Hort. Soc., New Ser., ii., 1890, pp. cxxxi.-cxxxii.; *loc. cit.*, iii., 1891, pp. 14-17.

<sup>17</sup> Mègnin—Comp. Rend., lxxvii., 1878, pp. 129-132, and pp. 492-3.

distinct, and the upper part of the body is furnished with a few hairs, and these are generally long. We are indebted to the labours of Michael<sup>18</sup> and Nalepa<sup>19</sup> for our knowledge of the anatomy of these animals, and to their writings students are directed. The mode of coition in the Tyroglyphidæ is exactly similar to that of the Analgesidæ. Behind the *anus* there is a small opening—the copulative aperture. In *Glyciphagus*, the *bursa copulatrix* projects externally into a small cone. Copulation is not performed through the *vulva*, but by this special opening.<sup>20</sup> This opening leads to a *receptaculum seminis*, which connects by a small duct to the ovaries. The transformations of these animals are amongst the most marvellous of the animal kingdom. All Tyroglyphidæ (except *Carpoglyphus*, Robin) appear to lay eggs, sometimes of a large size. The young on hatching are six-legged, and after moulting obtain two more. From thence they may pass on to the adult state in the normal way, but more frequently they pass through what has been already referred to as the *hypopial stage*. The *Hypopus* is very distinct from the octopod nymph from which it has developed. The body is hard and chitinous; there is no mouth orifice, and no distinct mouth parts. The legs are short and ill-adapted for walking. On the ventral surface at the posterior extremity there is an area distinct from the general surface. This area is provided with sucking discs, by means of which the animal clings to the body of an insect or other creature, and so the Acarid is carried about until it finds a suitable locality to undergo its next great change or molt, which transforms it into an octopod nymph that will feed and ultimately develop into an adult mite. Hence the hypopial stage is a phase in the life of a Tyroglyphid for the purpose of migration, but the causes which induce a nymph to transform to the *Hypopus* are not known.

When Tyroglyphids swarm in stored foods—cereals and the like—or buildings it is exceedingly difficult to combat them, since as they have no trachæ they are not very susceptible to fumigation, though some will succumb to the treatment. The writer once saw a grain merchant's store in Sydney in which these little wretches swarmed in countless millions, to eradicate which much time and no little expense had to be devoted.

Two indigenous species of Tyroglyphidæ have been recorded from Australia, but in addition to these others occur which have a more or less cosmopolitan range.

<sup>18</sup> Michael—Journ. Quek. Club, 1879, pp. 223-230, pl. xiii.

<sup>19</sup> Nalepa—Sitz. K. Akad. Wien., 1883, xc., pp. 197-228; Ann. Mag. Nat. Hist., xiv., 1883, pp. 369-371 (abstract).

<sup>20</sup> Banks—Proc. U. States Nat. Museum, xxviii., 1894, p. 79, 80.

*Genus* TYROGLYPHUS, Latr.

## TYROGLYPHUS QUEENSLANDICUS, Canest.

*Tyroglyphus queenslandicus*, Canest., Atti. Ist. Venet., (6), ii., 1885, p. 721.

*Hab.*—Queensland (on a Cetonid beetle).

## TYROGLYPHUS ENTOMOPHAGUS, Laboub.

*Tyroglyphus entomophagus*, Laboub., An. Soc. Ent. France, 1862.

*Tyroglyphus entomophagus*, Murray, Econom. Entom. (n.d.), p. 263.

*Hab.*—Cosmopolitan; Australia (introduced). Attacks entomological collections. According to Murray, "large insects, with the body full of fatty particles, those which have not lived long or which have been brought up in captivity, and which have not paired, and those which have become greasy (to use the technical expression), are most liable to attack."

## TYROGLYPHUS SIRO, Linn.

*Tyroglyphus siro*, Linn., Syst. Nat., x. ed., 1758, p. 616.

*Acarus siro*, Linn., *loc. cit.*

*Tyroglyphus siro*, Murray, Econom. Entom., (n.d.), p. 267, with figs.

*Hab.*—Cosmopolitan; Australia (introduced). Infests cheese, grain, dried meats.

*Genus* PULTEA, Canest.

## PULTEA DISCOIDALIS, Canest.

*Pultra discoidalis*, Canest., Atti. Ist. Venet., (6), ii., 1885, p. 720, pl. vi., f. 1.

*Hab.*—Australia (on a phytophagus beetle).

*Genus* ALEUROBIUS, Canest.

## ALEUROBIUS FARINÆ, De Geer.

*Aleurobius farinae*, De Geer, Mém. Inst., vii., 1778, p. 97.

*Acarus farinae*, De Geer, *loc. cit.*

*Hab.*—Cosmopolitan; Australia (introduced). Infests flour, grain, and stored foods. Does not appear to be common.

*Obs.*—Tryon refers to and figures a fungus-eating Tyroglyphid mite (? gen. *et* sp.).<sup>21</sup>

<sup>21</sup> Tryon—Queensl. Agric. Journ., 1898, p. 456, pl. lxxi., f. 3, 4.

*Genus* GLYCIPHAGUS, *Hering.*GLYCIPHAGUS DOMESTICUS, *De Geer.*

*Glyciphagus domesticus*, De Geer, Mém. Ins., vii., 1778, p. 89.

*Acarus domesticus*, De Geer, *loc. cit.*

*Glyciphagus domesticus*, Oudm., Tijds. Voor. Entom., xl., 1897, p. 251.

? *Glyciphagus prunorum*, Hering, Die Kratzmilben, 1835, p. 619.

*Hab.*—Cosmopolitan ; Australia (introduced). This species is sometimes found in cork, dust, tobacco, collections of herbaria, meals (such as flour), furniture. When it occurs in the latter it may be present in thousands. I have seen furniture in a house at Paddington, Sydney, where these Acarids were literally swarming. They feed on the animal fats of horse-hair when the latter has not been thoroughly cleaned. The species is also known to infest all kinds of dried vegetable and animal matter which is not too hard ; hay and fodder in stables, many vegetables and dungs, dried insects and fruits, sugar, and condensed milk which has been left exposed. *G. domesticus* is probably synonymous with Hering's *G. prunorum*, but the latter cannot be satisfactorily determined from the original description and figure which is lacking in certain important details. This Acarid is responsible for what is known as "grocers' itch." *G. domesticus* has also been recorded from the European "Blue Tit?" *Parus ceruleus*, Linn.

*Obs.*—Other species of this genus probably occur here, as in other parts of the world, seeing that bulbs and tubers are infested by them.

*Family* ANALGESIDÆ.

The Analgesidæ or "Bird Mites," is an extensive family including about thirty-one genera and seven sub-genera. These Acarids are found on birds all over the world, and their presence is regarded as beneficial to a host, from the fact that they keep the feathers and skin clean. Except the ticks few Acarids are better known than the Analgesidæ. Birds being so sought after by museums as well as private collectors, it is only natural that these little animals should find their way into collections, and so receive attention at the hands of systematists. A few species have been recorded from Australia and these are enumerated below. The Analgesidæ are more or less elongated animals with soft and transversely wrinkled skin ; usually the cephalothorax and abdomen are well-defined, but they are not endowed with

eyes nor stigmata ; the legs are usually short and stout, and arranged in two distinct groups ; the limbs have five joints, are provided with a few rather long hairs, systematically arranged, and each terminates with a rather large concave sucker, known as the *ambulacrum* : sometimes only one tarsal claw is present, and sometimes two. The mandibles are usually chelate, and finely toothed at the tip. The upper surface of the body is provided with a series of stiff bristles, and these present helpful specific characters. In dealing with the preceding family reference was made to the method of coition of the Tyroglyphidæ and Analgesidæ, so that the matter need not be referred to again here. The development and life history of this family is not well understood, but some species, at any rate, are known to pass through a hypopial stage. The egg is described as being large, elongate, slightly curved ; the newly hatched larva has usually six legs, but some forms occur in which only four are apparent. Although the nymph has the general form of the adult mite, it lacks the genital organs.

*Genus* FREYANA, *Haller.*

*Sub-Genus* EUFREYANA, *Canest. & Kram.*

FREYANA (E.) TARANDUS, *Troues. & Neum.*

*Freyana* (E.) *tarandus*, Troues. & Neum., Bull. Sci. France Belgique, 1888, xxix., p. 333, pl. xxii., f. 1 and 2.

*Hosts*.—*Ibis melanocephala*, Lath., *I. strictipennis*, J. Gd., *I. molucca*, Cuv., and *Theristicus melanopis*, Gm.

*Hab*.—India ; Moluccas, Australia, and Patagonia.

*Sub-Genus* MICHAELIA, *Troues.*

FREYANA (M.) CAPUT-MEDUSÆ, *Troues.*

*Freyana* (M.) *caput-medusæ*, Troues., Bull. Soc. Angers, xvi., 1886, p. 100.

*Michaelia caput-medusæ*, Troues. & Neum., Bull. Sci. France Belgique, xix., 1888, p. 374.

*Hosts*.—*Sula bassana*, Linn., and other species of the same genus.

*Hab*.—Australia, New Zealand, Europe, N. America.

*Genus* PTEROLICHUS, Robin.*Sub-Genus* EUPTEROLICHUS, Canest.

## PTEROLICHUS (E.) ORNATUS, Mégn. &amp; Troues.

*Pterolichus (E.) ornatus*, Mégn. & Troues., Journ. Micrograph., viii., 1884, p. 258, f. 2.

*Hosts*.—*Papegais*, *spp.*

*Hab.*—Australia, New Guinea, India.

## PTEROLICHUS (E.) PHYLLOPROCTUS, var. MINOR, Mégn. &amp; Troues.

*Pterolichus (E.) phylloproctus*, var. *minor*, Mégn. and Troues., Journ. Micrograph., viii., 1884, p. 334.

*Hosts*.—*Haliastur indus* var. *girrenera*, Vieill.

*Hab.*—Australia.

*Sub-Genus* PROTOLICHUS, Troues.

## PTEROLICHUS (PR.) BRACHIATUS, var. CRASSIOR, Troues.

*Pterolichus (Pr.) brachiatus*, var. *crassior*, Troues., Journ. Micrograph., viii., 1884, p. 529.

*Hosts*.—*Trichoglossus novæhollandiæ*, Gm., *Glossopsittacus concinnus*, G. Shaw, *Loriculus selateri*, Wall.

*Hab.*—Australia, New Guinea, Celebes.

## PTEROLICHUS (PR.) LUNULA, Robin.

*Pterolichus (Pr.) lunula*, Robin, Journ. Anat. et Physiol., xiii., p. 411, pl. xxiii., f. 1-3.

*Host*.—*Melopsittacus undulatus*, G. Shaw.

*Hab.*—Australia.

## PTEROLICHUS (PR.) CHIRAGRICUS, Mégn. &amp; Troues.

*Pterolichus (Pr.) chiragricus*, Mégn. & Troues., Journ. Micrograph., viii., 1884, p. 261.

*Pterolichus affinis* (part), Mégn. & Troues., *loc. cit.*, p. 262.

*Hosts*.—*Pezoporos formosus*, Lath., *Platyercus jarcolus*, J. Gd., and *P. elegans*, Gm.

*Hab.*—Australia, New Zealand.

PTEROLICHUS (PR.) VELIFER, *Mégn. & Troues.*

*Pterolichus (Pr.) velifer*, Mégn. & Troues., Journ. Micrograph., viii., 1884, p. 262.

*Pterolichus (Pr.) affinis* (part), Mégn. & Troues., *loc. cit.*, p. 262.  
 ,, *velifer*, Troues., Bull. Soc. Ent. France, 1898, p. 290.

*Hosts.*—*Nymphicus cornutus*, Gm., *Pyrrhulopsis personata*, G. R. Gray, and *Platycercus flavicollis*, J. Gd.

*Hab.*—Fiji, New Caledonia, Australia.

PTEROLICHUS (PR.) FAVETTEI, *Troues.*

*Pterolichus (Pr.) favettei*, Troues., Bull. Soc. Ent. France, 1898, p. 290.

*Hosts.*—*Nestor notabilis*, J. Gd., *N. meridionalis*, Gm., *Psephotus xanthorrhous*, Bp., and *Microglossus aterrimus*, Gm.

*Hab.*—Australia, New Guinea, New Zealand.

PTEROLICHUS (PR.) FALCULIGER, *Troues.*

*Pterolichus (Pr.) falculiger*, Troues., Journ. Micrograph., viii., 1884, p. 531.

*Host.*—*Glossopsittacus concinnus*, G. Shaw.

*Hab.*—Australia.

*Sub-Genus* PSEUDALLOPTES, *Troues.*PTEROLICHUS (PS.) AQUILINUS, *var. MILVULINA*, *Troues.*

*Pterolichus (Ps.) aquilinus*, *var. milvulina*, Troues., Journ. Micrograph., viii., 1884, p. 573.

*Hosts.*—*Milvus milvus*, Linn., and *Haliaster indus* *var. girrenera*, Viell.

*Hab.*—Australia and New Guinea.

PTEROLICHUS (PS.) SPATHULIGER, *Troues.*

*Pterolichus (Ps.) spathuliger*, Troues., Journ. Micrograph., viii., 1884, p. 577.

*Host.*—*Calyptorhynchus macrorhynchus*, J. Gd.

*Hab.*—Australia.



## PTEROLICHIUS (Ps.) CULTRIVENTRIS, Troues.

*Pterolichus (Ps.) cultriventris*, Troues., Journ. Micrograph., viii., 1884, p. 577.

*Host.*—*Glossopsittacus concinnus*, G. Shaw.

*Hab.*—Australia.

*Genus* ANALGES, Nitzsch.

## ANALGES TETRACENTRUS, Troues.

*Analges tetracentrus*, Troues., Bull. Soc. Angers, xxviii., 1899, p. 30.

*Host.*—*Psephotus hamatonatus*, J. Gd.

*Hab.*—Australia.

*Genus* PROTALGES, Troues.

## PROTALGES AUSTRALIS, Troues.

*Protalges australis*, Troues., Bull. Soc. Angers, xiv., 1885, p. 55.

*Host.*—*Glyciphila fasciata*, J. Gd.

*Hab.*—Australia.

## PROTALGES CARTUS, Troues.

*Protalges cartus*, Troues., Bull. Soc. Angers, xiv., 1885, p. 56.

*Host.*—*Platycreus elegans*, Gm.

*Hab.*—Australia.

*Genus* ALLOPTES, Canest.

## ALLOPTES LOBULATUS, Troues.

*Alloptes lobulatus*, Troues., Bull. Soc. Angers, xiv., 1885, p. 65.

*Host.*—*Meliornis sericeus*, J. Gd.

*Hab.*—Australia.

## ALLOPTES SECURIGER, Troues.

*Alloptes securiger*, Troues., Bull. Soc. Angers, xiv., 1885, p. 65.

*Host.*—*Dicaeum hirundinaceum*, Shaw and Nodd.

*Hab.*—Australia.

ALLOPTES CORYMBOPHORUS, *Troues. & Neum.*

*Alloptes corymbophorus*, Troues. & Neum., Bull. Sci. France  
Belgique, xix., 1888, p. 367, pl. xxv., f. 4.

*Host.*—*Ibis molucca*, Cuv.

*Hab.*—Australia.

ALLOPTES MAJOR, *Troues.*

*Alloptes major*, Troues., Bull. Soc. Angers, xiv., 1885, p. 78.

*Host.*—*Menura superba*, Davies.

*Hab.*—Australia.

*Genus* TROUESSARTIA, *Canest.*

= *Pterocolus*, Schœn., (*nom. præoc.*)

TROUESSARTIA CAUDACUTA, *Troues.*

*Trouessartia caudacuta*, Troues., Bull. Soc. Angers, xxviii., 1899,  
p. 171.

*Pterocolus caudacutus*, Troues., *loc. cit.*

*Host.*—*Lobivanellus lobatus*, Lath.

*Hab.*—Australia.

*Genus* PTERODECTES, *Robin.*PTERODECTES PARADISIACUS, *Troues.*

*Pterodectes paradisiacus*, Troues., Bull. Soc. Angers, xiv., 1885,  
p. 80.

*Hosts.*—*Pardisea minor*, G. Shaw, and *Sericulus melinus*, Lath.

*Hab.*—Australia and New Guinea.

PTERODECTES MANICATUS, *Troues.*

*Pterodectes manicatus*, Troues., Bull. Soc. Angers, xiv., 1885, p.  
81.

*Host.*—*Glycyphila fasciata*, J. Gd.

*Hab.*—Australia.

*Family* LÍSTROPHORIDÆ.

Only one species of this small family has been recorded from the Australian region, and that from Tasmania. These parasites live upon small mammals, including bats. They are small, the body usually tapering a little posteriorly, legs widely separated, sometimes—according to those who have studied the family—each pair is at an equal distance from the adjoining ones; dorsally there are a few short hairs with longer ones at the tip: the surface is usually transversely striate, and the rostrum or beak forms a distinct cone on the front of the head; palpi simple, filiform, three-jointed; mandibles very small, commonly chelate; genital apertures situate between third and fourth coxæ; anus at tip of body. Males invariably differently shaped to females and provided with a pair of copulatory suckers near tip of venter.<sup>22</sup>

The Listrophoridae feed on the hairs of their hosts.

*Genus* CAMPYLOCHIRUS, Troues.

## CAMPYLOCHIRUS CHELOPUS, Troues.

*Campylochirus chelopus*, Troues., Compt. Rend. Soc. Biol., xlv., 1893, p. 699.

*Host.*—Opossum (*Pseudochirus cooki*, Desm.).

*Hab.*—Tasmania.

*Family* SARCOPTIDÆ.

This family includes a number of species which are, unquestionably, the most disgusting of the entire Acarid Group. These microscopic animals are notorious for their parasitism on the human subject and domesticated animals, causing intense physical suffering and often great monetary loss. *Sarcoptes scabiei*, Geer, is unfortunately common in Australia, and affects human beings. It is responsible for what is probably one of the oldest skin diseases known. The Greeks called it ψώρα (from ψῶ, I rub) and the ancient Romans *scabies* (from *scabere*, to scratch). In England it is *itch*, *scald*, *guck* (*mango*); *gale* in France; *Krätze* and *Krätzausschlag* in Germany; *scabia*, *rogna* and *raspa* in Italy; and *sarna*, *roña* in Spain. Speaking more accurately, *scabies* is known to medical science as *acariasis*. The history of the disease is a most interesting one which the reader may peruse for himself.<sup>23</sup>

<sup>22</sup> Banks *Loc. cit.*, p. 94.

<sup>23</sup> Neumann—Parasites and Parasitic Diseases of Domesticated Animals, translated by George Fleming, London, 1892, pp. 112-116.

The Sarcoptidæ are white, semi-globose; the body entire; surface transversely striated and provided with a few bristles, often short, stout and sharp-pointed; legs short and arranged in two groups, and of these the posterior pairs are usually the shorter; the tarsi usually terminate with a sharp claw and a long pedicellate sucker; the claw or sucker may, however, be absent and in place thereof there may be a long bristle: the beak is prominent and the palpi small and three-jointed, and lie closely pressed to the sides of the beak beneath.

The female Sarcoptid burrows into the skin of its host, depositing its eggs as it goes. On hatching out, the young, which are six-legged, start burrowing on their own account, so that the sufferer may be affected in patches. The *cuniculi* or burrows are close to the surface, so that as the epidermis loosens scaly effects are produced. The irritation produced causes vesicles or pustules to occur, and these may become ulcerated by scratching. When the female has completed the task of depositing her eggs, she dies at the end of her burrow. The presence of Sarcoptids on the lower animals is the cause of what is popularly known as mange. The latter disease is common enough on dogs and cats; it occasionally occurs on horses and sheep, but no cases are on record in respect of cattle; pigs, too, I am informed by Mr. J. D. Stewart, Government Veterinary Surgeon, are in New South Wales at any rate, free from Sarcoptid troubles, and I believe I am correct in saying that the same remark applies to the other States.

*Genus* NOTOEDRES *Raill*

NOTOEDRES CATI, *Hering*.

*Notoedres cati*, Hering, N. Acta. Ac. Leop., xviii. 1838, p. 605, pl. xlv., f. 9, 10.

*Sarcoptes cati*, Hering, *loc. cit.*

*Sarcoptes cati*, Neum., Parasites and Parasitic Diseases of Domesticated Animals (Fleming trans.), 1892, p. 125, f. 72 and p. 208.

*Sarcoptes notoedres*, var. *cati*, Mégn., Paras., 1880, p. 174.

*Notedrus cati*, Canest., Prosp. Acarof., vi., 1894, p. 752.

*Notedrus cati*, Berl., Acari. Myriap. Scorp. Italia, fasc. 79, (2), 1896.

*Sarcoptes minor*, Fürstenb., Krätzm., 1861, p. 215, pl. 8.

*Hosts*.—Cats, rabbits.

*Hab*.—Europe, Australia (introduced).

*Genus SARCOPTES, Latr.*SARCOPTES CANIS, *Gerl.*

- Sarcoptes canis*, Gerl., Krätz., 1857, p. 141, pl. ii. and iii., f. 11-14.  
*Sarcoptes canis*, Canest., Prosp. Acarof., vi., 1894, p. 741, pl. lxiii., f. 1-3.  
*Sarcoptes canis*, Neum., Parasites and Parasitic Diseases of Domesticated Animals, 1892, p. 124 and p. 202.  
*Sarcoptes canis*, Berl., Acari. Myriap. Scorp. Italia, fasc. 79, (1), 1896.  
*Sarcoptes squamiferus* (part), Fürstenb., Krätz., 1861, p. 214, pl. iv.

*Hosts*.—The dog, and sometimes man.

*Hab*.—Cosmopolitan ; Australia (introduced).

SARCOPTES EQUI, *Gerl.*

- Sarcoptes equi*, Gerl. (non *Sarcoptes equi*, Hering, 1838), Krätz., 1857, p. 72, pl. ii., f. 8-10.  
*Sarcoptes equi*, Canest., Prosp. Acarof., vi., 1894, p. 745.  
*Sarcoptes scabiei*, var. *equi*, Mégn., Paras., 1880, p. 164, pl. ix.  
*Sarcoptes scabiei*, var. *equi*, Neum., Parasites and Parasitic Diseases of Domesticated Animals, 1892, pp. 122, 123, f. 65-69.

*Hosts*.—The horse ; sometimes man.

*Hab*.—Cosmopolitan ; Australia (introduced).

SARCOPTES SCABIEI, *Geer.*

- Sarcoptes scabiei*, Geer, Mém. Hist. Ins., vii., 1778, p. 94, pl. v., f. 12, 13.  
*Acarus scabei*, Geer, *loc. cit.*  
*Acarus siro* (part) + *Acarus exulcerans*? Linn., Syst. Nat. ed. x., 1758, pp. 616, 617.  
*Sarcoptes hominis*, Hering, N. Acta. Ac. Leop., 1838, xviii., p. 584.  
*Sarcoptes scabiei*, var. *hominis*, Mégn., Paras., 1880, p. 169.  
*Sarcoptes hominis*, Canest., Prosp. Acarof., vi., 1894, p. 738, pl. 70.  
*Sarcoptes hominis*, Banks, Proc. U. States Nat. Mus., xxviii., 1904, pp. 96, 97, f. 181, 182 and 184.  
*Sarcoptes communis* (part), Delaf. & Bourg., Mém. Pres. Ac. France, xvi., 1862, p. 290.

*Host.*—The human subject.

*Obs.*—I am indebted to Prof. D. A. Welsh and Dr. H. G. Chapman, of the Sydney University, for much generous assistance in my study of parasites affecting the human subject. From the former, who kindly communicated with Dr. F. A. Bennet, I learn that *scabies* is fairly common amongst patients presenting themselves at the Royal Prince Alfred Hospital. Dr. Corbin, Medical Superintendent at the Sydney Hospital, informs me that *scabies* is one of the commonest skin diseases; and from Dr. Chapman who, on my behalf, communicated with Dr. Noyes of Melbourne, I learn that much the same condition of things obtains in the Victorian capital.

*Hab.*—Cosmopolitan; Australia (introduced).

SARCOPTES WOMBATI, *Raill.*

*Sarcoptes wombati*, Raill., Zool., 2nd ed., 1893, p. 659.

*Sarcoptes scabiei*, var. *wombati*, Raill., *loc. cit.*

*Hosts.*—The Tasmanian Wombat (*Phascodomys ursinus*, G. Shaw); sometimes found upon man.

*Hab.*—Tasmania.

Genus CNEMIDOCOPTES, *Fürstb.*

CNEMIDOCOPTES MUTANS, *Robiu.*

*Cnemidocoptes mutans*, Robin, Bull. Soc. Moscou, xxxiii., 1860, p. 184.

*Sarcoptes mutans*, Robin, *loc. cit.*

*Cnemidocoptes mutans*, Canest., Prosp. Acarof., vi., 1894, p. 755, pl. lxx., f. 1-3, pl. lxxvi., f. 1-4.

*Cnemidocoptes mutans*, Berl., Acari. Myriap. Scorp. Italia, fasc. 84, (6), 1897.

*Sarcoptes anacanthos*, Delaf. & Bourgn., Mém. Pres. Ac. France, xvi., 1862, p. 261.

*Cnemidokoptes viviparus*, Fürstenb., Mt. Ver. Vorpomm., ii., 1870, p. 56.

*Sarcoptes mutans*, Brads., N. S. Wales Agric. Gaz., xvii., 1906, pp. 125-131, pl. and text figs.

*Hosts.*—Domestic fowls. This mite, *C. mutans*, is responsible for the disease in poultry known as "Scaly Leg."

*Hab.*—Cosmopolitan; Rockdale, N.S.W. (introduced).

*Genus PSOROPTES, Gerv.*PSOROPTES EQUI, *Hering.*

*Psoroptes equi*, Hering, N. Acta. Ac. Leop., xviii., 1838, p. 585, pl. xliii., f. 1, 2.

*Sarcoptes equi*, Hering, *loc. cit.*

*Dermatodectes equi*, Gerl., Krätz., 1857, p. 90, pl. iv.

*Psoroptes longirostris*, var. *equi*, Mégn., Paras., 1880, p. 191, pl. xiii.

*Psoroptes equi*, Canest., Prosp. Acarof., vi., 1894, p. 761.

*Psoroptes communis* var. *equi*, Neum., Parasites and Parasitic Diseases of Domesticated Animals, 1892, pp. 126-129, f. 73-79.

*Dermatocoptes equi*, Fürstenb., Krätz., 1861, p. 220, pls. 12-15

*Hosts.*—Horse, ass.

*Hab.*—Cosmopolitan; Australia (introduced).

*Genus CHORIOPTES, Gerv.*? CHORIOPTES OVIS, *Raill.*

? *Chorioptes ovis*, Raill., Zool., 2nd ed., 1893, p. 675.

*Chorioptes symbiotes*, var. *ovis*, Raill., *loc. cit.*

*Host.*—Sheep. This species is, I believe, *C. ovis* of Railliet. The form occurring in Australia was introduced on sheep from America. The species included in this genus are restricted in their attacks to certain parts of the animal, as the feet, the ears or neck. In this State the feet are attacked, and give rise to what is known as "foot mange." Cases of this trouble are, however, few and far between.

*Hab.*—Europe?, America?, Australia (introduced).

*Family ERIOPHYIDÆ.*

The family, although including only a few genera is rather extensive in point of species. Only one form has, so far, been recorded from Australia—*Eryophes pyri*, Scheuten, and this is parasitic on the pear. All the species are of strictly phytophagous habits, and many of them cause galls to form on the leaves of their food plants. The early history of the study of these animals is interesting. Some individuals in the old school of botanists regarded Eriophyd galls as Cryptogams, and described them as such under the generic names *Erinium*, etc. These gall mites are an extraordinary

group, and it is scarcely to be marvelled that they should, before they were properly understood, have been regarded as occupying a position in the domain of botany. These mites differ from all others in that the adults have only *four* legs, all seated near the anterior part of the body. The animal is long and tapering, divided into two parts—cephalothorax and abdomen; the former is short and broad, the latter long and multi-articulate.

*Genus* ERIOPHES, *Sieb. & Nal.*

ERIOPHES PYRI, *Pagenst.*

- Eriophes pyri*, Pagenst., Verh. Ver. Heidelberg, i., 1857, p. 48.  
*Phytophus pyri*, Nal., Anz. Ak. Wien., xxvi., 1889, p. 162; Sitzb. Ak. Wien, xcix., 1890, p. 50, pl. iv., f. 1, 2.  
*Phytophus arianus* + *P. cotoneastri* + *P. sorbi*, Canest., Atti. Soc. Ven.-Trent., xii., 1890, pp. 16, 20, 21, pl., f. 7-9, pl. vi., f. 14.  
*Phytophus aronia*, Canest., Difesa dai Parassiti, i., 1890, p. 282.  
*Phytophus pyri*, French, Handb. Destruc. Ins. Vict., pt. 1, 1891, pp. 119-123, pl. xiv.  
*Eriophyes piri*, Nal., Das Tier., Lief. 4, 1898, p. 25.

*Host Plant.*—Pear trees.

*Hab.*—Cosmopolitan; Australia (introduced).

*Family* DEMODECIDÆ.

A small family consisting of one genus and a few species. The species are all parasitic, the host affected being the human subject, domesticated animals and *Mus musculus*, Linn. The mites lurk in the sebaceous glands and hair follicles; they are small, elongate, with eight three-jointed legs, thorax broad, abdomen tapering, transversely striated above and below, and rounded off at posterior extremity. One species only appears to be known as occurring here. Stringent quarantine laws are responsible for the immunity of our domestic animals.

*Genus* DEMODEX, *Owen.*

DEMODEX FOLLICULORUM, *G. Simon.*

- Demodex folliculorum*, G. Simon, Arach. Anat. Physiol. Med., 1842, pp. 218-237, pl. xi.  
*Acarus folliculorum*, G. Simon, *loc. cit.*  
*Demodex folliculorum*, Owen, Lect. Invert. Anat., 1843, p. 252.



*Dermodes hominis*, Leydig, Arch. Naturg., xxv., 1859, p. 345, pl. xiii., f. 6.

*Dermodes folliculorum*, var. *hominis*, Mégn., Journ. Anat. et Physiol., xiii., 1877, p. 112.

*Dermodes folliculorum*, var. *hominis*, Raill., Zool., 2nd ed., 1893, p. 634.

*Macrogastrer platypus*, Meischer, Ber. Ges. Basel, v., 1843, p. 191-198.

*Host.*—The human subject.

*Hab.*—Cosmopolitan ; Australia (introduced).

In concluding this Synopsis I desire to express my indebtedness to Mr. S. Johnston, B.Sc., of the Technological Museum, who kindly lent me his collection of microscopic slides of Australian Acarid parasites for reference and study.

DESCRIPTIONS OF AND NOTES ON SOME AUSTRALIAN  
AND TASMANIAN FISHES.

By EDGAR R. WAITE, F.L.S., Zoologist.

(Plates xxxiv.-xxxvi.).

In October 1905 I spent three weeks in Melbourne and vicinity, and devoted some time to collecting fishes. In this connection I have to acknowledge the kindness of the Victorian Railway Commissioners in granting me concessions over all their lines traversed. I also desire to thank Mr. C. W. Maclean, Chief Inspector of Fisheries, for much personal assistance, and permission for the use of nets in closed waters, poisons, and other methods employed in my investigations. I paid almost daily visits to the Melbourne Fish Markets and also collected on the coast, principally at Queenscliff, where I received every attention and assistance from Inspector Brady. While in Melbourne I met Mr. Joseph Gabriel, who is interested in Mollusca, and he has since kindly sent to the Trustees some small fishes, taken by means of the dredge.

In consequence of leaving Australia for New Zealand I have been unable to deal with all the fishes obtained, and have indeed devoted attention to comparatively few species. A few fishes from N. S. Wales and Tasmania are also included.

The new species are:—

- \* <sup>1</sup>*Diplocrepis parvipinnis*, N. S. Wales.
- \* *Ophioclinus gabrieli*, Victoria.
- \*        ,,       *gracilis*, N. S. Wales.

The following known species, not being included in Mr. A. H. S. Lucas' "Census" of 1890,<sup>2</sup> are regarded as additions to the Victorian fauna.

- Stolephorus robustus*, Ogilby,
- \* *Cheilobranchus rufus*, Macleay,
- \* *Crepidogaster spatula*, Günther,
- Diplocrepis costatus*, Ogilby.

---

<sup>1</sup> The species marked \* are figured, the drawings being made by Mr. A. R. McCulloch.

<sup>2</sup> Lucas—Proc. Roy. Soc. Viet., (2), ii., 1890, p. 15, *et seq.*

Some species, not recognised in Victoria since first described, were retaken, and their claims to inclusion in the fauna (upon which doubt had been cast), fully established. The Melbourne Sole described as *Rhombosolea basseusis*, Castlenau, is now placed in the genus *Peltorhamphus*. The name *Scleropteryx* is used generically for *Ophioclinus devisi*, Ogilby.

Additional species redescribed or furnishing material for some remark are :—

- Gobius mucosus*, Günther, S. Australia, Victoria, N. S. Wales.
- \* *Diplocrepis cardinalis*, Ramsay, Tasmania,
- \* *Rhombosolea flesoides*, Günther, Victoria,
- \* *Bleinnius tasmanianus*, Richardson, Tasmania, Victoria, N. S. Wales.

STOLEPHORUS, *Lacépède*, 1803.

STOLEPHORUS ROBUSTUS, *Ogilby*, sp.

*Spratelloides robustus*, Ogilby, Proc. Linn. Soc. N. S. Wales, xxii. 1897, p. 64.

This small Herring has not been previously recorded from Victorian waters. I obtained several examples from Queenscliff and it is probable that many more would have been secured if a smaller meshed net had been used.

These southern examples have all the habit of *S. delicatulus*, Bennett, being of slender body, unlike typical examples of *S. robustus*. The specimens collected have had most of their scales rubbed off in transit, but as far as can be ascertained these are smaller and more numerous than in *S. delicatulus*, which feature provides the readiest means of determination, if indeed the species be distinct.

CHEILOBRANCHUS, *Richardson*, 1845.

CHEILOBRANCHUS RUFUS, *Macleay*.

(Plate xxxvi., fig. 1).

*Chilobranchus rufus*, Macleay, Proc. Linn. Soc. N. S. Wales, vi., 1881, p. 266.

The length of the head is one-eighth of the total, or 2·3 in the distance between the gill-opening and the vent, and that between the end of the snout and the vent is 1·5 in the remaining por-

tion; the height of the body is 8·6 in the total. The eye is 3·4 in the length of the head and partially concealed by membrane; the nostril is placed close to its anterior upper margin; the mouth is small, almost horizontal and the maxilla reaches nearly to below the middle of the eye.

The dorsal fin commences, as nearly as can be ascertained, above the vent and joins the anal round the end of the tail; the anal arises at a third of the distance between the vent and the end of the caudal.

*Colours.*—The general colour is red with six or seven large purple spots along the middle of each side; these do not extend posteriorly beyond the origin of the anal fin, and may not be evenly disposed on both sides.

Richardson,<sup>3</sup> in describing the gill-opening of *C. dorsalis*, writes:—"A transverse lip, which rises above the adjoining integument, and has its outer ends free, forms the posterior edge of the orifice, and appears to be capable of closing it very completely when the inflected edge of the membrane is pressed against it." This "lip" is also present in *C. rufus*; it is not a median process as might be inferred, but really a pair of organs which to my eye are nothing but rudimentary pectoral fins. They lie rather low down on the body, some distance apart, close behind, but quite free from the gill-membranes, and it is very doubtful if they have any function in connection therewith, as supposed by Richardson.

The specimen above described was forwarded by Mr. Gabriel from Port Phillip, and constitutes a record for Victoria. It is indistinguishable from examples taken in Tasmania and New South Wales, and as far as may be decided, without specimens for comparison, from Richardson's species also. The example recorded by this author from South Victoria Land (Penguin Island, 72° S. Lat.) under the name *C. aptenodytum*<sup>4</sup> is placed by Dr. Günther as synonymous with *C. dorsalis* from N. W. Australia. If the species be the same, the extremes of latitude reached, furnish a remarkable instance of geographical range.

Local examples of this little eel exhibit some colour variations: some are marked as above described, others are intense carmine all over, and a few specimens are similar but mottled with lighter tints.

---

<sup>3</sup> Richardson—Voy. Ereb. & Terr., 1845, p. 50, pl. xxx., fig. 1-5.

<sup>4</sup> Richardson—*Loc. cit.*, p. 51.

RHOMBOSOLEA, *Günther*, 1862.RHOMBOSOLEA FLESOIDES, *Günther*.

(Plate xxxv.).

*Rhombosolea flesoides*, *Günther*, Ann. Mag. Nat. Hist., (3), xi., 1863, p. 117.

*Pleuronectes? victoria*, *Castelnau*, Proc. Zool. Soc. Viet., i., 1872, p. 168.

*Rhombosolea victoria*, *Macleay*, Proc. Linn. Soc. N. S. Wales, vi., 1881, p. 133.

*Flounder.*

D. 66, A. 47; P. 12; V. *dex.* 6, *sin.* O.; C. 12 + 4; Sc. 72.

Length of head 3.5; depth of body 2.1, and length of caudal 4.2 in the total length. Eyes on the right side, separated by a smooth narrow space, one-fourth the diameter of the eye; the lower eye is noticeably in advance of the upper and the diameter is 4.8 in the length of the head, or but slightly less than that of the snout; the latter is produced into a fleshy process directed downwards over the mouth. The anterior nostril may be closed by a trilobed process. The hinder one lies posterior to the front edge of the lower eye and is a simple pore. The mouth is of moderate size extending to nearly below the anterior margin of the eye: it is more extensive on the blind side, and has two rows of teeth in each jaw; the nostrils have a higher and more anterior position than on the right side. Gill-rakers small, conical, and smooth, slightly fenestrated on the inner side; about thirteen in number on the lower limb, scarcely developed on the hinder one. Gills three and a half, a slit behind the last, equal to the diameter of the eye. The gill openings are small, not extending to the upper angle of the pectoral above, and closed below the preopercular angle beneath.

*Fins.*—The dorsal commences on the rostral process, about an eye diameter from its extremity. Though partially free anteriorly, all the rays are connected by membrane. They are highest about the middle of the fin where they form a conspicuous angle, the thirty-fifth or longest ray being 1.9 in the length of the head. The rays are continued to within an eye-diameter of the caudal rays. The ventral commences beneath the middle of the eye and is quite continuous with the anal, the apparent omission of one ray only indicating the distinction. The vent is situated on the left side contiguous to this space. The anal is similar to the dorsal the sixteenth ray being the longest. The right pectoral is

pointed above, its length being 1·5 in the length of the head: the left fin is shorter, 1·9 in the same, and is symmetrical, the central rays being the longest. The caudal is truncate or very slightly rounded, and the depth of the peduncle is 2·2 in the head.

*Scales.*—The forepart of the head, the interorbital space, the margins of the opercula and the bases of the pectorals are naked; the body is covered on both sides with cycloid scales, non-imbricate on the anterior portion, but overlapping behind, and upon the caudal peduncle. Fins scaleless.

The lateral line runs almost straight, there being a slight curve over the anterior half of the pectoral, which is less marked on the blind side; anteriorly, on both sides, the line is continued over the head to the base of the seventh or eighth dorsal ray.

*Colours.*—Uniform grey above and yellow beneath

Length 242 mm.

This species was commonly offered for sale in Melbourne, and at Queenscliff examples were taken in the seine. At the latter place a long series of pools extend between the railway and the harbour, the home of shoals of Atherines. While wading in the pools I commonly disturbed some fishes which zigzagged on the bottom, and raised small clouds of mud. I discovered these to be young flounders, from one inch to three inches in length. When disturbed they swam rapidly away as described, for two or three yards, and then usually doubled back along their tracks, so that when the mud settled it was not possible to locate them. Nearly all those caught were obtained under my feet, whence they had evidently gone for the purpose of hiding, for an old boot, bucket or other object, on being lifted, was found to harbour many young flounders.

PELTORHAMPHUS, *Günther*, 1862.

• PELTORHAMPHUS BASSENSIS, *Castelnau*, *sp.*

(Plate xxxiv.).

*Rhombosolea bassensis*, *Castelnau*, Proc. Zool. Soc. Vict., i., 1872, p. 167.

*Sole.*

D. 79; A. 54; P. *d*x. 11, *sin.* 9; V. *d*x. 7, *sin.* 4; C. 12 + 4;  
Sc. 79.

Length of head 4·0; depth of body 1·74 in total length exclusive of the caudal which equals the head in length. Eyes, on the right side, separated by a flat scaly space, less than half their

diameter, which is 4·8 in the head. The length of the snout is one-fifth more than the diameter of the eye, or one-fourth the length of the head, it is produced into a fleshy process which covers the mouth anteriorly. The lower eye is slightly in advance of the upper one. Both nostrils are tubular and arise from the only naked part of the head: the anterior one has a valve-like flap behind. The mouth is small and toothless on the coloured side and is wholly in advance of the eyes and nostrils: it is large on the left side, extending far beyond the sinistral nostrils, and is furnished with several rows of movable teeth in both jaws. The nostrils occupy a slightly more dorsal position than those on the right side. Gill-rakers 11 + 2, reduced to mere knobs, the anterior ones scarcely apparent. Gills four and a half, a small slit, not more than a third the diameter of the eye, behind the last. The gill openings extend to the upper angles of the pectorals, but are arrested below by membrane beneath the middle of the eye.

*Scales.*—Head, with the exception of a small space round each pair of nostrils, body and fins, wholly clothed with small ctenoid scales, almost equally developed on both sides; no accessory scales.

*Fins.*—The dorsal fin commences at the extremity of the nasal process: the anterior rays are quite free of membrane and the tips of those following are free to above the opercular margin, the first seventeen rays are serrate behind. The highest rays occur about the middle of the fin where they are rather more than half the length of the head. The right ventral commences at the symphysis of the lower jaw and is connected by membrane with the anal. The left ventral is small having its rays close together and situated in advance of the vent. The anal is similar to the dorsal and terminates evenly with it. The pectorals are of similar length, half that of the head, but the right one has more rays and a rounded margin; in the left the central rays are much the longest, producing a lanceolate shaped fin. The caudal is slightly rounded, its peduncle deep, being 1·6 in the length of the head.

*Colours.*—Brownish grey above, white below.

Total length, 234 mm.

This is the common sole of the Melbourne markets where I obtained the specimens examined. I also netted it at Queenscliff.

Though described by Castelnau under the genus *Rhombosolea* it is clear that it cannot be there assigned; the scales are stated to be "strongly ciliated which makes the fish feel rough to the touch." Cycloid scales are a character of the genus. Though

this author writes of the dorsal and anal fins in the singular, he describes the ventrals in the plural, which tends to confirm the natural supposition that Castelnau's fish and mine are identical. The characters of this species all point to *Peltorhamphus* Günther, of which one species only *P. nove-zealandie*<sup>5</sup> was previously identified. The Victorian fish differs from the description of the New Zealand one, among other characters, by having the dorsal and anal rays covered with scales.

GObIUS, *Linneus*, 1758.

GObIUS MUCOSUS, *Günther*.

*Gobius mucosus*, Günther, Proc. Zool. Soc., 1871, p. 663, pl. lxiii, fig. A.

*Gobius depressus*, Ramsay & Ogilby, Proc. Linn. Soc. N. S. Wales, (2), i., 1886, p. 4.

D. vi. i. 10; A. i. 9; V. i. 5; P. 17; C. 17.

Length of head 3·6; height of body 5·5, and length of caudal 3·0 in the total. Eyes 3·2 in the length of the head, cutting the profile and less than a diameter apart; their diameter greater than the length of the snout. Cleft of mouth approaching the vertical, the lower jaw the longer; the maxilla does not nearly reach the orbit. Head much depressed, the skin of which is thrown into sharp folds; the plications on the snout are irregular, those on the cheeks vertical, a pair of transverse folds on the occiput, followed by two longitudinal ones, and another long pair on each side arising from the margins of the upper and lower jaw respectively; the inferior aspect of each ramus of the lower jaw bears a series of about a dozen short transverse bars, resembling the teeth of a cog-wheel.

*Fins*.—The fourth dorsal spine is the longest, one-half the length of the head; the anal commences evenly with the soft dorsal and terminates in advance of the posterior rays; the pectorals attain to below the origin of the soft dorsal, and the ventrals do not reach the vent; caudal long and pointed.

Anal papilla small, rounded.

*Colours*.—Yellow, marbled with brown; under surface, as far as the vent, white. All the fins, except the ventrals, spotted with black or dark brown forming bars, longitudinally disposed on the dorsal and anal, and transversely on the pectoral and

---

<sup>5</sup> Günther—Cat. Fish. Brit. Mus., iv., 1862, p. 461.



caudal fins. The head is devoid of scales and is deeper in tint than the body, the plications being darker still.

Günther attributed these folds to mucous, but they are distinctly dermal in nature. A comparison of the type of *G. depressus* with examples forwarded from Port Phillip by Mr. Gabriel, shows them to be identical, while there can be little doubt that they are correctly referred to *G. mucosus*, described by Günther from South Australia.

PENTAROGE, *Günther*, 1860.

PENTAROGE MARMORATA, *Cuvier & Valenciennes*, *sp.*

*Apistus marmoratus*, Cuvier & Valenciennes, Hist. Nat. Poiss., iv., 1829, p. 416; Valenciennes, Reg. Anim. Ill. Poiss., pl. xxiv., fig. 3.

*Pentaroge marmorata*, Günther, Cat. Fish. Brit. Mus., ii., 1860, p. 132; Castelnau, Proc. Zool. Soc. Vict., i., 1872, p. 82.

*Cobbler.*

Castelnau remarks that this fish is scarce at Melbourne, and gives its local name as "Barber." I found it to be very common at Queenscliff, where it is as well-known and as equally dreaded as the "Portesque" (*Centropogon australis*) of the Sydney fishermen. It was taken by scores in every haul of the seine and recognised under the name "Cobbler," both at Queenscliff and in the Melbourne market.

The markings appear to be very constant and remarkably well-defined; the similarity to those of the *Centropogon* mentioned, being noticeable. Valenciennes' figure of a Timor specimen does not well represent the species as found in Victorian waters.

CREPIDOGASTER, *Günther*, 1861.

CREPIDOGASTER SPATULA, *Günther*.

(Plate xxxvi., fig. 4).

*Crepidogaster spatula*, Günther, Cat. Fish. Brit. Mus., iii., 1861, p. 508.

D. 6; A. 6; P. 26; V. i. 4; C. 12 +  $\times$  Vert. 16 + 16.

Length of head 2.6; width 3.5; height of body 5.0; width 4.7 in the total length. The snout is broad at the level of the eyes but narrows anteriorly, its length being one-third that of the head. The mouth is large extending to nearly beneath the middle of the

eye; the upper jaw, which is the longer, has a complete reflexed lip; in the lower jaw the lips do not meet at the symphysis. Teeth in both jaws very small, villiform, the anterior ones in the upper jaw forming a patch. The nostrils are near to the front margin of the eye, the anterior one bearing a small tentacle. The eye is round, 4.2 in the length of the head and little more than half the inter-orbital space, which is flat.

The head is very broad and depressed and the body is sub-cylindrical anteriorly, but compressed behind. No subcutaneous spine on the opercle, nor on the preopercle.

The distance between the end of the snout and the origin of the dorsal is nearly twice that between the latter point and the end of the caudal. The dorsal fin is very short, its base being equal to its distance from the caudal. The pectoral is broad and rounded, its length 2.5 in that of the head: the ventral is attached to its sixteenth ray. The adhesive disc is broader than long, its length half the width of the head. The distance of the vent from the disc is twice that from the anal. This fin is precisely similar to the dorsal in form and situation. The caudal is rounded, its length being equal to half that of the head, and the height of the peduncle equal to its own length.

*Colours*.—Colour throughout yellow, the head and body above and on the sides ornamented with crowded carmine spots, those on the head round, those on the body lengthened; the upper ones arranged transversely to form closely packed bands. Fins and lower surfaces without markings.

Total length 64 mm.

Three specimens forwarded by Mr. Gabriel, are additions to the recorded fauna of Victoria. Previously the species was known from Swan River, Western Australia. It is a well-marked form, readily distinguishable by the short and oppositely placed vertical fins, and the backward position of the vent.

DIPLOCREPIS, *Günther*, 1861.

DIPLOCREPIS PARVIPINNIS, *sp. nov.*

(Plate xxxvi., fig. 3).

D. 5; A. 5; P. 16 + ×; C. 9.

Length of head 3.2; width 4.6; and height of body 6.1. The snout is much narrower than the head, shorter than the eye and 4.1 in the length of the head. The maxilla extends to just beyond the anterior margin of the orbit. The teeth

are conical, disposed in a patch within each jaw, and a single series of larger teeth along the sides. The nostrils lie close together in front of the eye, the anterior one bearing a tentacle. The eye is large, it cuts the upper profile and is 3·7 in the length of the head. The inter-orbital breadth is narrow, equal to the length of the eye.

Head depressed, body cylindrical.

The distance between the origin of the dorsal and the end of the caudal is 1·8 in that between the former point and the end of the snout. Both dorsal and anal fins are widely separated from the caudal: the former is slightly in advance of the anal which commences beneath its second ray. The pectoral is rounded, the middle rays being longest, 3·2 in the length of the head, the lower rays rapidly decrease in length and the ventral is attached to the sixteenth ray. The posterior sucking disc is almost circular, a little broader than long, and reaches only to beneath the middle of the pectoral: the distance of the vent from the disc is thrice that between it and the anal. The caudal is slightly rounded, its length 2·4 in that of the head; the length of the peduncle is more than twice its depth.

*Colours.*—In life, olive green, uniform, or with brown spots on the body, arranged as bands, or with bands fully defined which are four in number: a brown or red mark on the side of the snout through the eye to the preopercle.

Length 25 mm.

This diminutive species was first brought to my notice by Mr. A. R. McCulloch, who found it on a seaweed, identified by Mr. T. Whitelegge as *Phyllospora comosa*, Agard. It proves to be a common fish on the coast of New South Wales, and examples in the collection of the Museum were previously regarded as young specimens of another species.

#### DIPLOCREPIS COSTATUS, Ogilby.

*Diplocrepis costatus*, Ogilby, Proc. Linn. Soc. N. S. Wales, x., 1885, p. 270; Waite, Rec. Austr. Mus., v., 1904, pl. xxiv., fig. 1.

Mr. Gabriel's collection includes a single example of this species, an addition to the Victorian fauna.

DIPLOCREPIS CARDINALIS, *Ramsay, sp.*

(Plate xxxvi., fig. 1).

*Gobiesox cardinalis*, Ramsay, Proc. Linn. Soc. N. S. Wales, vii., 1882, p. 148.

D. 10 ; A. 7 ; P. 22 ; C. 11.

Length of head 2·7 ; width 3·0 ; height of body 5·1 ; width 4·3 in the total length. The snout is obtusely pointed, short, its length 4·0 in that of the head. The angle of the mouth is beneath the anterior fourth of the eye and is almost concealed by the overhanging preopercles. A patch of conical teeth in each jaw, the outer series the larger. The opercle is represented by a bony rod ending in a long spine, and the preopercle bears a smaller spine, both being concealed beneath the skin. Both nostrils are furnished with tentacles, of which the anterior is the larger. The eye is 5·0 in the head and equal to half the inter-orbital breadth.

The distance between the origin of the dorsal and the end of the caudal is 1·7 in that between the former point and the end of the snout. Both dorsal and anal fins lie close to the caudal but are not connected with it: the anal commences below the middle of the dorsal and has a slightly more posterior termination. The length of the pectoral is 2·7 in that of the head and the ventral is attached to its fourteenth ray. The posterior sucking disc has a free anterior margin and is much broader than long, its width being 1·4 in the breadth of the head; it extends to beneath the end of the pectoral. The vent is nearer to the disc than to the anal, the relative distance being as 3 to 5. The caudal is subtruncate, its length a little more than half that of the head.

*Colours*.—The life colours are not known. In fluid, all examples are uniform yellow.

Length 70 mm.

Three specimens from near Launceston, Tasmania, collected in 1879, by Mr. K. Broadbent, and three from Ulverstone, Tasmania, forwarded by the Curator of the Victoria Museum, Launceston, in 1903. One of the former batch is very possibly the type of the species, but the characters above given are derived from one of the more recent acquisitions. The somewhat shrivelled condition of the author's specimens, if such they be, may account for the differences noted. In the first place the structure of the posterior sucking disc is not that of *Gobiesox*, and the number of dorsal and anal rays is understated. Otherwise the specimens agree well with the description and I have no hesitation whatever in

assigning them to this species: the opercular spine is characteristic, as is also the presence of tentacles on both nostrils. The word "compressed" in the description of the head is an obvious error.

The four known species of *Diplocrepis* may be recognised by the following characters:—

DIPLOCREPIS PUNICEUS, *Richardson, sp.*

*Lepidogaster puniceus*, Richardson, Voy. Ereb. & Terr., 1846, p. 71, pl. xliii., fig. 1-7.

D. 11; A. 5. The anal fin commences behind the middle of the dorsal; the vent is placed close to the sucking disc, at a great distance from the anal.

*Hab.*—New Zealand.

DIPLOCREPIS CARDINALIS, *Ramsay, sp.*

*Gobiesox cardinalis*, Ramsay, Proc. Linn. Soc., N. S. Wales, vii., 1882 p. 148.  
*Diplocrepis cardinalis*, Waite, *antea*, p. 204, pl. xxxvi., fig. 1

D. 10; A. 7. The anal fin commences below the middle of the dorsal; the vent is placed somewhat nearer to the sucking disc than to the anal.

*Loc.*—Ulverstone, Tasmania.

DIPLOCREPIS COSTATUS, *Ogilby.*

*Diplocrepis costatus*, Ogilby, Proc. Linn. Soc. N. S. Wales, x., 1885, p. 270;  
Waite, Rec. Austr. Mus., v., 1904, pl. xxiv., fig. 1.

D. 8; A. 7. The anal fin commences slightly behind the origin of the dorsal; both are close to the caudal. The vent is placed much nearer to the anal than to the sucking disc.

*Hab.*—N. S. Wales, Lord Howe Island, Victoria.

DIPLOCREPIS PARVIPINNIS, *Waite.*

*Diplocrepis parvipinnis*, Waite, *antea*, p. 202, pl. xxxvi., fig. 3.

D. 5; A. 5. The anal commences beneath the second dorsal ray, and both are far removed from the caudal; the vent is placed much nearer to the anal than to the sucking disc.

*Hab.*—N. S. Wales.

BLENNIUS, *Linnaeus, 1758.*

BLENNIUS TASMANIANUS, *Richardson.*

(Plate xxxvi., fig. 5).

*Blennius tasmanianus*, Richardson, Proc. Zool. Soc., 1839, p. 99;  
Trans. Zool. Soc., iii., 1849, p. 129.

D. xii. 18; A. 20; P. 14; V. 2; C. 7 + 6.

Length of head 3·7; height of body 3·8; and length of the caudal 4·8 in the length of the fish. Eyes large, cutting the pro-

file less than half a diameter apart, 3.1 in the length of the head and a little longer than the snout. Orbital tentacles not longer than the depth of the eye, simple and fringed behind. Small pores occur around the eye and on the preopercular margin. The maxilla extends to beneath the centre of the eye. The teeth are as is usual in the genus with posterior canines.

*Fins.*—The dorsal fin commences behind the vertical of the preopercle; the first spine is a little shorter than the eye, the 4-7 spines are equal, and slightly longer than the diameter of the eye, and the last spine is the shortest, half the length of the first ray; the 3-12 rays are equal, twice the length of the first spine, which latter is about the same height as the last ray. The base of the soft is one-seventh longer than that of the spinous portion; the anterior anal rays are only one-half the height of the median dorsal ones, they increase slightly in height posteriorly. The pectoral is pointed, the ninth and longest ray being nearly equal to the head in length, extends to the anal fin. The inner ventral ray is half the length of the head. The caudal is sub-truncate and the least depth of its peduncle is one-third the length of the head. The lateral line is composed of about twenty-four tubes of which seventeen form an arch over the pectoral; the others, which are less defined and more widely spaced, are horizontally disposed; there are no pores on the posterior half of the body.

*Colour.*—The ground colour is olive, darker above than below; the head is marked with three obliquely vertical bars, of which the first passes through the eye and forms a  $\vee$  with its fellow on the throat, the second diverges from the first below the eye backwards to the edge of the gill membrane, and the third occurs behind the preopercle; the body is marked with nine transverse bars formed each of two series of black spots, which do not attain the lower surface. There is a black spot between the first two dorsal spines, and the base of the fin is shaded in accord with the body bars; the anal bears a dark sub-marginal band. There are no markings on the other fins.

Total length 47 mm.

The single specimen examined was dredged by Mr. Gabriel in Western Port. It is the one illustrated, and is a half-grown example. Specimens of this age differ from the adults by the shorter orbital tentacle, the much longer and pointed pectoral fin, the simple anal papilla, and the much larger eye, in addition to constant markings which do not appear to be maintained to adult age.

Mr. A. M. Lea, Government Entomologist, Tasmania, has forwarded to the Trustees a nice series of this species. I am not

aware of the colours of the adult during life : preserved examples undergo peculiar changes similar to members of the Kyphosidae : these are usually manifested as large irregular blotches of black or brown on a pale yellow ground. The markings are adventitious, not alike in two fishes, and both sides of the same specimen are usually quite dissimilar.

OPHIOCLINUS, *Castelnau*, 1873.

OPHIOCLINUS GRACILIS, *sp. nov.*

(Plate xxxvi., fig. 6).

D. xliii. + 1 ; A. iii. 29 ; P. 13 ; V. 2 ; C. 11 + 4 ; Vert.  
19 + 32 = 51.

Length of head 4·9 ; height of body at the anal fin 7·4 ; length of caudal 9·0 in the total. The diameter of the eye is one-fifth the length of the head, equal to the interorbital space, and three-fourths the length of the snout. The anterior nostril is in a short tube, a little nearer to the end of the snout than to the eye : the posterior nostril is one of numerous large pores, disposed on the snout, around the eye, on the occiput, preopercle, and lower jaw.

*Teeth.*—A patch of conical teeth within each jaw, and a narrow band on each side ; teeth on the vomer, none on the palatines.

*Fins.*—The dorsal commences in advance of the operculum, the first spine is two-thirds the diameter of the eye and the fin increases in height backwards, the single ray being twice the length of the first spine and joined to the caudal. The anal fin commences below the seventeenth dorsal spine and is formed of three short spines, followed by longer rays which are slightly longer than the corresponding dorsal spines. The pectoral is rounded, about one-half the length of the head and somewhat shorter than the inner ventral ray. The caudal is truncate, the depth of its peduncle more than one-third the height of the body.

*Scales.*—Head naked, body covered with small non-imbriate scales (not shown in the illustration). The lateral line commences beneath the first dorsal spine ; it is strongly arched and is not continued beyond the end of the pectoral : a median depression to the caudal may be traced in some examples, but this is apparently not a true "lateral line."

*Colours.*—The general colour is brown above and yellowish beneath, but great variations occur. The illustration represents

a specimen in which the markings are very well defined and such consist of a longitudinal black band which passes from the snout, through the eye to the tail: it deepens posteriorly and embraces the body and caudal peduncle and is also continued in blotches on to the dorsal and anal fins. The top of the head and the back including the fin is white. In other examples the band is brown, sometimes very faint, and the vertical fins may be of the same tint; when the head-band is pale in colour it may have a black lower margin; the extension of the band posteriorly may be indicated by some spots on the side of the tail. The pectorals are generally and the ventrals always white, and if the vertical fins are coloured they have a light margin.

Of many specimens examined, the largest measured 57 mm. in length. This species has been taken at various times in rock pools at Long Bay, near Sydney, by Mr. A. R. McCulloch.

*OPHIOCLINUS GABRIELI*, *sp. nov.*

(Plate xxxvi., fig. 7).

D. li. + 1; A. 36; P. 12; V. 2; C. 11 + 4; Vert. 21 + 39 = 60.

Length of head 5.3; height of body, at the origin of the anal, 7.5; length of caudal 8.0 in the total. Eye prominent, large, close to the upper profile, 4.2 in the length of the head, and twice the interorbital space. Length of snout little more than half the diameter of the eye and bearing two short tentacles, immediately above the upper lip. The maxilla reaches to beneath the third fourth of the eye.

*Teeth*.—An extensive patch of small granular teeth within the margin of each jaw, followed by a narrow band on each side; teeth on the vomer but none on the palatines. A broad frenum in the upper jaw.

*Fins*.—The dorsal commences above the opercle, but its origin is not well defined, and is composed wholly of spines with the exception of one ray, the last, which is joined to the caudal: the fin rises rapidly to the fourth spine and thence is of fairly uniform height, the spines lengthening somewhat posteriorly; the median height of the fin is about one-third that of the body at the commencement of the anal.

The anal fin arises beneath the nineteenth or twentieth dorsal spine and is formed wholly of soft rays; it is similar to, but slightly higher than the dorsal and is joined to the caudal. The pectoral is short and rounded, its middle rays 2.4 in the length of the head. The ventrals are jugular in position, close together



and formed, each of two stout rays, the inner being the longer, a little more than half the length of the head. The caudal is rounded, and the depth of its peduncle 2.5 times in the height of the body.

*Scales.*—The scales are scarcely apparent, they are deeply imbedded, small and widely separated anteriorly, larger and closer together posteriorly. The head is naked but bears a number of large pores, especially developed on the snout, around the eyes, and within the margin of the preopercle. The lateral line is developed anteriorly only, and is placed above the pectoral but does not extend as far as the margin of the fin.

*Colours.*—The general colour is brown, lighter beneath. A dark band passes through the eye to the preopercle which latter has no defined edge, being included in the common covering of the head. The lower and posterior portions of the body bear some light marbled markings, which extend on to the anal and caudal fins; the other fins are without markings.

Three examples were dredged by Mr. Gabriel, the largest of which measures 102 mm. in length. They are fully adult, the two females carrying young. These can be distinctly seen through the abdominal integument and in one individual numbered thirty-six, each being 12 mm. long.

The genus *Ophioclinus* was defined by Castelnau<sup>7</sup> in 1873, with *O. antarcticus* as the type species. In 1894 Ogilby<sup>8</sup> described a fish from Queensland under the name *O. devisi* and remarked that "the neglect of Castelnau to even mention the pectorals is negative evidence as to their existence in his genus." In his generic definition Castelnau distinctly refers to the pectorals as follows:—"Ventral fins inserted in front of the pectorals," and again in his specific description:—"pectorals much shorter than the ventrals, of ten rays." I have examined the type of *O. devisi* and find that pectorals are not present, and it follows therefore that it cannot enter *Ophioclinus* and may tentatively be regarded as the type of *Scleropteryx*, a name proposed by De Vis, but which apparently never reached beyond the manuscript stage. Ogilby's definition of *Ophioclinus* will therefore apply to *Scleropteryx*, and not to Castelnau's genus.

*O. gabrieli* differs from *O. antarcticus* by having two instead of three ventral rays, and by the smaller number of spines and rays in the dorsal and anal fin respectively.

<sup>7</sup> Castelnau—Proc. Zool. Soc. Viet., ii, 1873, p. 69.

<sup>8</sup> Ogilby—Proc. Linn. Soc. N. S. Wales, (2), ix., 1894, p. 373.

PSEUDOMONACANTHUS, *Bleeker*, 1866.PSEUDOMONACANTHUS GRANULATUS, *Shaw*, *sp.*

*Balistes granulata*, Shaw, in White's Voy. N.S. Wales, 1790, p. 295, pl. (p. 254), fig. 2.

This is another species whose existence in Victorian waters is regarded by Mr. A. H. S. Lucas as doubtful, no one having, apparently, identified it since Klunzinger first recorded it from Port Phillip. I obtained specimens in the Melbourne Fish Market.

SPHEROIDES, *Dumeril*, 1806.SPHEROIDES RICHEI, *Fréminville*, *sp.*

*Tetraodon richei*, Fréminville, Nouv. Bull. Philom., ii., p. 250, pl. iv., fig. 2.

This species is included in the Victorian fauna, apparently only on the authority of Klunzinger.<sup>9</sup> I found it to be not uncommon at Queenscliff where it was taken by means of the seine net.

Castelnau "observed two sorts [of *Tetraodon*] on the shores of Hobson's Bay," namely:—*T. hamiltoni*, Richardson, and *T. hispidus*, Linnæus. It is quite evident however, from his description, that the species recorded under the latter name is really referable to *S. richei*, and that in all probability *T. hispidus* does not occur in Hobson's Bay. *S. hamiltoni* was found to be extremely common, and appears to attain larger dimensions than in Port Jackson.

---

<sup>9</sup> Klunzinger - Sitz. Ak. Wiss. Wien., lxxx., 1879, p. 425.

MOLLUSCA FROM THREE HUNDRED FATHOMS,  
OFF SYDNEY.

By C. HEDLEY, Conchologist, and W. F. PETTERD.

(Plates xxxvii. and xxxiii.).

Various excursions have reaped a superficial knowledge of the Mollusca of our Continental Shelf. In a recent issue of these Records a collection was described which Mr. G. H. Halligan obtained in one hundred and ten fathoms off Cape Byron. A haul made by the same gentleman and one of us in one hundred fathoms off Wollongong, supplemented the collections trawled by the "Thetis" Expedition in from twenty to eighty fathoms between Jervis Bay and the Manning River.

It was evident that at a greater distance from the coast, in deeper and colder water, another fauna would appear. To search this zone the writers organised a dredging trip. We were greatly aided by the kindness of Mr. H. E. Farmer, who, on behalf of Messrs. Bullivant, generously placed at our disposal a reel and five hundred fathoms of wire rope. A serviceable steamer of seventy-four tons, the "Woy Woy," fitted with steam winding gear, was engaged for the trip. We enjoyed the company and assistance of Dr. R. Palleine, Messrs. E. R. Waite, G. A. Waterhouse, F. E. Grant and A. R. McCulloch. The weather on the chosen date was excellent. Taking our departure at 8 a.m. on March 27, 1905, from mid-channel between Port Jackson Heads, we set a due east (true, not magnetic) course, and ran by the patent log, twenty-seven and a half miles. On sounding no bottom was got at two hundred and fifty fathoms. Estimating the depth at three hundred fathoms, we put the bucket dredge over and paid out most of our wire rope. A full load of sandy mud, coloured green by glauconite, rewarded us. The temperature of the mud when it arrived on board was 60° F.

Before again sinking the bucket we fastened a dredge to its taper end by forty fathoms of rope. This length allowed the dredge to follow on the ocean floor a track different to that of the bucket. If tied closer it would in pursuing the same path have only collected material already crushed by the passage of the bucket. Both bucket and dredge returned with a satisfactory load, but a final descent of the dredge alone proved a failure.

While dredging we had drifted inshore and estimated that the second haul was in a depth of two hundred and fifty fathoms, at a distance of twenty-three miles due east of South Head. We returned to port after an absence of twelve hours.

The study of the Crustacea was undertaken by Mr. F. E. Grant, and his paper<sup>1</sup> has already appeared.

The Corals have been examined by Mr. J. Dennant, who will shortly publish an account of them.

An Elaspod Holothurian was determined by Mr. T. Whitelegge as *Pannychia moseleyi*, Theel. There was also a fine Sea-pen of the genus *Kophobolemuon*. Representatives of other groups have been handed to various specialists and it is hoped that further reports on them may appear. The types of all new species described in this article are presented to the Trustees of the Australian Museum.

The decided change of fauna between the one hundred fathom level and the zone touched by our dredge, appears to us to indicate that the animals obtained grew below the warm southerly current.

About twenty-five miles south-south-west of the position of our dredging lies the "Challenger" Station 164 B., where, in four hundred and ten fathoms, a large series of mollusca are reputed to have been obtained. A large proportion of these were well-known Atlantic species. This incongruous mixture has been considered by Crosse<sup>2</sup> and other writers as clear evidence of error. One of us has discussed<sup>3</sup> the matter at length and recommended the rejection of the whole tainted haul.

Perhaps the most important result of our excursion is the re-discovery of about half of the new "164 B" shells, but none of the European species occurred with them. It is evident that the "Challenger" collectors had mixed gatherings from different oceans, and while those here recognised are rehabilitated, the balance had best be carried to a suspense account awaiting further investigation.

It is no longer possible to check the "Challenger" results by dredging at 164 B, because the submarine telegraph cable to New Zealand crosses the place.

More than a hundred species of shells are contained in the collection, some are fragmentary, or for other reasons cannot be determined. The following is a list of those identified.

---

<sup>1</sup> Grant—Proc. Linn. Soc. N. S. Wales, xxx., 1905, pp. 312-324.

<sup>2</sup> Crosse—Journ. de Conch., xliii., 1895, p. 257.

<sup>3</sup> Hedley—Proc. Linn. Soc. N. S. Wales, xxvi., 1901, p. 22.

- Amusium thetidis*, Hedley.  
*Adacnarca squamea*, Hedley.  
*Astete glyptus*, Watson.  
*Bathytoma agnata*, Hedley and Petterd.  
*Bittium fuscocapitulum*, Hedley and Petterd.  
*Bulla incommoda*, Smith.  
*Bullina scabra*, Gmelin.  
*Cadulus spretus*, Tate and May.  
*Cancellaria scobina*, Hedley and Petterd.  
*Capulus devotus*, Hedley.  
*Carditella angasi*, Smith.  
*Cardium pulchellum*, Gray.  
*Carinaria australis*, Quoy and Gaimard.  
*Cassida pyrum*, Lamk.  
*Carolinia gibbosa*, Rang.  
     " *inflexa*, Lesueur.  
     " *longirostris*, Lesueur.  
     " *quadridentata*, Lesueur.  
     " *tridentata*, Forskal.  
     " *trispinosa*, Lesueur.  
*Cerithiopsis cacaminatus*, Hedley and Petterd.  
*Chlamys asperrimus*, Lamarck.  
*Clio pyramidata*, Linne.  
     " *subula*, Quoy and Gaimard.  
     " *virgula*, Rang.  
*Cocculina tasmanica*, Pilsbry.  
*Columbarium pagodoides*, Watson.  
*Coralliophila lischkei*, Dunker.  
*Cuma delta*, Tate and May.  
*Cuspidaria angasi*, Smith.  
*Cuvierina columnella*, Rang.  
*Cyclostrema johnstoni*, Beddome.  
*Cylichna ordinaria*, Smith.  
     " *protumida*, Hedley.  
     " *thetidis*, Hedley.  
*Cymatium kampyla*, Watson.  
*Cyrella dalli*, Hedley.  
*Daphnella vestalis*, Hedley.  
*Dentalium erectum*, Sowerby.  
*Drillia coxi*, Angas.  
     " *crosseri*, Smith.  
     " *tricarinata*, Ten. Woods.  
     " *woodsii*, Beddome.  
*Ectorisma granulata*, Tate.

- Emarginula superba*, Hedley and Petterd.  
*Euthria tabida*, Hedley.  
*Hemithyris columnus*, Hedley.  
*Leda inopinata*, Smith.  
   " *miliacea*, Hedley.  
   " *rumsayi*, Smith.  
*Linea murrayi*, Smith.  
*Limopsis tenisoni*, Ten. Woods.  
   " *erectus*, Hedley and Petterd.  
*Mangelia emina*, Hedley.  
   " *watsoni*, Smith.  
*Marginella agapeta*, Watson.  
   " *allporti*, Ten. Woods.  
   " *brazieri*, Smith.  
   " *cratericula*, Tate and May.  
   " *laevigata*, Brazier.  
   " *ochracea*, Angas.  
   " *stillia*, Hedley.  
   " *strangei*, Angas.  
*Mathilda decorata*, Hedley.  
*Monilia arata*, Hedley.  
   " *oleacea*, Hedley and Petterd.  
   " *philippensis*, Watson.  
*Murex licinus*, Hedley and Petterd.  
*Nassa jacksonensis*, Quoy and Gaimard.  
*Pleurotoma casearia*, Hedley and Petterd.  
*Polinices subcostatus*, Ten. Woods.  
*Poroleda ensicula*, Angas.  
*Poromya undosa*, Hedley and Petterd.  
*Rissoa filocincta*, Hedley and Petterd.  
*Rochefortia acuminata*, Smith.  
   " *lactea*, Hedley.  
*Scada morchii*, Angas.  
*Terebra lauretanus*, Ten. Woods.  
*Tiberia nitidula*, A. Adams.  
*Trophon carduelis*, Watson.  
   " *laminatus*, Petterd.  
   " *simplex*, Hedley.  
*Turbonilla constricta*, Smith.  
*Turritella godeffroyana*, Donald.  
   " *incisa*, Reeve.  
   " *philippensis*, Watson.  
   " *sinnata*, Reeve.

- Venericardia cavatica*, Hedley.  
*Verticordia rhomboidea*, Hedley.  
*Voluta undulata*, Lamarek.  
*Fulpecula miranda*, Smith.  
 „ *tasmanica*, Ten. Woods.  
*Xenophora tatei*, Harris.

The new and noteworthy species include the following:—

*COCCULINA TASMANICA*, Pilsbry, *sp.*

*Acmæa parva*, Angus, var. *tasmanica*, Pilsbry, *The Nautilus*, viii., 1895, p. 128; *Nacella tasmanica*, Tate and May, Proc. Linn. Soc. N. S. Wales, xxvi., 1901, p. 411, pl. xxvii., f. 89-90; *Cocculina meridionalis*, Hedley, Mem. Austr. Mus., iv., 1902, p. 331, f. 64.

The presence of an inrolled often caducous apex directed the assignment of this species to *Cocculina*, and as that genus had not been reported from Australasia, the shell was by one of us described as new. Mr. W. L. May pointed out the similarity between *N. tasmanica* and *C. meridionalis*. After interchange of specimens we agree that they are identical. Mr. H. Suter, who holds a cotype and joined in the discussion, arrives at the same conclusion. The species has recently occurred in deep water off the New Zealand coast.

*MONILEA OLEATA*, *sp. nov.*

(Plate xxxvii., fig. 1).

Shell rather large, thin, regularly turbinate, base flattened, periphery subangled, spire elevated. Whorls seven, gradually increasing, regularly rounded except a narrow flat step below the suture. Colour beneath white, above pale cinnamon with darker radial streaks on the last whorl. Entire surface glossy, as if well oiled. Sculpture: closely scored by sharp spiral cuts, which are deepest about the periphery, fainter midway up the whorl and vanish from the base and from the first four whorls. On the penultimate whorl between the insertion of the lip and the suture, there are sixteen of these impressed spirals. The flat interspaces are obliquely crossed by faint irregular growth lines. Aperture very oblique ovate, upper insertion carried far forward, connected with the lower by a thin dull film of callus. Lip quite sharp, within a white edge is followed by a brown border and that again by a nacreous layer. This sequence again appears along the interior

suture. Umbilicus a broad open funnel, penetrating to the initial whorl, margined by a beaded funicle which ends in an expansion on the columella base. The interior of the umbilicus is spirally scored like the periphery, and is undercut at the junction of each whorl. Height 12 mm.; major diameter 16 mm.; minor diameter 13 mm.

A single perfect specimen from two hundred and fifty fathoms, twenty-three miles east of Sydney.

*EMARGINULA SUPERBA*, *sp. nov.*

(Plate xxxvii., figs. 7 and 8).

Shell large, elevated, oval, rather thin, apex much incurved and overhanging at five-sixths of the length. The sides are arched so that the shell only touches a plane surface by its extremities. Colour, exterior gray, interior white. Fissure deeply slit. Sculpture: about sixty sharp elevated radiate riblets which frill the interior margin and are parted by narrow deep interstices in which arise fine secondary riblets. A concentric series of numerous dense imbricating scales traverse both ribs and furrows. Slit fasciole elevated, two thin erect walls include fine close curved transverse scales. The interior of the fasciole is marked by a heavy streak of callus. Length 24 mm.; breadth 18 mm.; height 9 mm.

A single specimen from two hundred and fifty fathoms.

This is the largest Australian species, and only two or three species in the world exceed it in size.

*CYCLOSTREMA JOHNSTONI*, *Beddome.*

*Cyclostrema johnstoni*, Beddome, Proc. Roy. Soc. Tasm., 1882 (1883), p. 168; *Id.*, Tate, Trans. Roy. Soc. S. Austr., xxiii., 1899, p. 215, pl. vii., f. 7 *a*, *b*.

Two specimens of this Tasmanian species from three hundred fathoms, are the means of adding it to the fauna of this State.

*TIBERIA NITIDULA*, *A. Adams, sp.*

(Plate xxxviii., fig. 13).

*Syrnola nitidula*, A. Adams, Ann. Mag. Nat. Hist., 1860, (3), vi., p. 335.

*Pyramidella nitidula*, Sowerby, Conch. Icon., xv., 1865, Pyramidella, pl. v., f. 35.



*Odostomia (Obeliscus) nitidula*, Watson, Chall. Rep., Zool., xv., 1886, p. 487.

“This species,” remarks Dr. W. H. Dall,<sup>4</sup> “is very widely distributed, both in area and depth.” Its range extends from Japan to the Mediterranean and West Indies, but it has not been recorded before from the Southern Hemisphere. In our collection it is represented by a single specimen 7 mm. long, taken in two hundred and fifty fathoms.

*RISSOA FILOCINCTA*, *sp. nov.*

(Plate xxxvii., fig. 2).

Shell small, opaque and rather solid, broadly ovate, narrowly perforate. Whorls five, of which one and a half compose the protoconch, ventricose, the earlier whorls angled above, the last rounded, rapidly increasing, not descending at the aperture, sharply constricted at the sutures. Sculpture: protoconch smooth, in adult shell the radials first predominate, gradually grow denser and finer and are at last exceeded by the spirals. The body whorl carries twelve sharp, erect, wide spaced spirals, of which the upper are latticed by forty-two radial riblets proceeding from the suture and fading at the periphery. Twenty stronger radial ribs, whose interstices are traversed by five spirals, cross the penultimate whorl. The remaining whorl and a half has twenty-one coarse, wide set radials, with a spiral thread above and below. Aperture perpendicular ovate, fortified by a thick out-standing varix. Length 3 mm.; breadth 1·7 mm.

Several specimens from both hauls.

*BITTIUM FUSCOCAPITULUM*, *sp. nov.*

(Plate xxxviii., figs. 10 and 11).

Shell rather large, thin, broad at the base, with straight sides, tapering to a sharp point, angled and contracted at the base. Colour pale purple, granules white, protoconch chocolate brown. The individual drawn has fifteen whorls in a length of eleven mm., but a larger decapitated example is thirteen and a half mm. for

---

<sup>4</sup> Dall—Bull. Mus. Comp. Zool., xviii., 1889, p. 334.

eleven remaining whorls. Sculpture : the adult shell commences with simple ribs springing from the surface above and below and projecting at the periphery. The gradual appearance of spiral sculpture depresses the ribs in the middle and elevates them above and below in angular tubercles. Finally the ribs break up into bead rows, the last whorl having a smooth central belt through which runs a spiral thread, on either side lie first a large and then a small bead row, containing about nineteen grains to a whorl ; no varix is present. The suture is impressed and sinuous. Protoconch sharply differentiated by substance, colour and sculpture, of four whorls with a double keel and delicate radial riblets, terminating in a deep bay above a long and narrow lobe. The concave base meets the periphery at a sharp angle and is ornamented by a few shallow, wide spaced concentric grooves. Aperture oblique, subquadrate ; lip sharp, simple, the short canal is merely a deep sinus. Length 11 mm. ; breadth 3 mm.

A few dead shells.

After *Bittium granarium*, the novelty is one of the largest Australian members of the genus. The presence of a sinusigera protoconch is of interest, but we have not sufficient data to now discuss its teleological significance.

*CERITHIOPSIS CACUMINATUS, sp. nov.*

(Plate xxxvii., fig. 4).

Our broken specimens, though exhibiting features sufficient to separate them from known species, do not supply the material for a complete description. Shell very long, slender and gradually tapering to an inflated two-whorled protoconch, each whorl overhanging its successor pagoda-wise. Colour grey. Whorls at least nineteen. Sculpture : each whorl carries about thirteen longitudinal folds which taper upwards and do not continue from whorl to whorl. Three spiral belts and intervening shallow furrows of corresponding width develop beads on the radials. The lowest chain of beads is the most prominent, and those above diminish in succession. Beneath the largest bead row is a narrow revolving double thread. The beads are more polished than the interstices. Towards the summit the spiral sculpture fades away, a sutural furrow persisting longest. The first two adult whorls have only radial ribbing. Length of imperfect specimen 10 mm. ; breadth 2 mm.

The slender tapering spire and triple row of unequal beads marks the species as clearly different from Australian co-generic forms.

Two specimens from two hundred and fifty fathoms.

CYMATIUM KAMPYLA, *Watson, sp.*

*Nassaria kampyla*, Watson, Journ. Linn. Soc., Zool., xvi., 1883, p. 594; *N. campyla*, Watson, Chall. Rep., Zool., xv., 1886, p. 405, pl. xiv., f. 12; *Lampusia nodocostata*, Tate and May, Trans. Roy. Soc. S. Austr., xxiv., 1900, p. 90; *Id.*, Proc. Linn. Soc. N. S. Wales, xxvi., 1901, p. 355, pl. xxiii., f. 2; *Lotorium nodocostatum*, Kesteven, Proc. Linn. Soc. N. S. Wales, xxvii., 1902, pp. 463, 479, f. 1 and 4.

A full series taken in each haul by the "Woy Woy," and reference to a "Challenge" co-type, enables us to connect the immature shell described by Tate and May with the adult form discovered by the "Challenger." All codes of nomenclature agree that an author is not permitted to alter a name once published, the first form of the specific name is therefore here adopted. The change from "kampyla" to "campyla" proposed by Dr. Watson would be particularly inconvenient for an index.

CORALLIOPHILA LISCHKEANA, *Dunker, sp.*

*Rapana lischkeana*, Dunker, Index Moll. Mar. Jap., 1882, p. 43, pl. i., f. 1, 2, pl. xiii., f. 26, 27; *Purpura sertata*, Hedley, Austr. Mus. Mem., iv., 1903, p. 382, f. 95, 96; *Id.*, Pritchard and Gatliff, Proc. Roy. Soc. Viet., (n.s.), xviii., 1906, p. 44.

Several specimens, one alive, of this Japanese species were captured at two hundred and fifty fathoms. This series connects the adult with the young shell described as *Purpura sertata*.

MUREX LICINUS, *sp. nov.*

(Plate xxxvii., fig. 6).

Shell rather small, short, broad, angled at the shoulder, obliquely biconical. Canal short, open. Apex acute, bent away from the

shell's axis. Colour pale brown, inner lip light purple. Whorls six and a half, rapidly increasing. Sculpture: numerous varices, eight to the last whorl, beset the shell. They are low, but erect, feebly denticulate, descend obliquely from the shoulder to the base, above the shoulder converge very obliquely to the suture across an excavate unribbed space. On the upper whorls they fade rapidly, becoming extinct on the penultimate. The inter-variceal spaces are traversed by stout spiral ribs divided by broad deep grooves, about a dozen appearing behind the aperture, no scales occur on ribs or in grooves. Outer lip expanded, smooth within, denticulate without, edged with concentric frills. Inner lip straight below, arched medially, its margin expanded, free. Length 17 mm.; breadth 13 mm.

A single living specimen from two hundred and fifty fathoms, which may not be adult.

*PLEUROTOMA CASEARIA, sp. nov.*

(Plate xxxvii., fig. 5).

Shell thin, slender, fusiform, spire keeled and turreted, base contracted. Whorls seven, including a whorl and a half of protoconch, parted by linear rather oblique impressed sutures. Colour varying from pearl grey to pale orange, usually cheese colour. Sculpture: the protoconch is glassy with rounded whorls, the adult smooth and somewhat glossy though duller than the protoconch. The periphery is sharply produced into a projecting keel, the fasciole set with pointed radiating tubercles, of which the penultimate whorl bears eighteen, these tubercles continue upwards, diminishing proportionately to the protoconch, but downwards they degenerate on the last whorl to imbricating scales. The unarmed keel slightly rises at its termination, bringing the shelf above it nearer to the horizontal. The fasciole ends in a deep and narrow slit. Canal open, produced, bent a little to the right. Under the lens, delicate growth lines appear which diverge acutely above and below the keel, crossing the base they are flexed. Aperture narrowly pyriform, a callus spread on the inner lip. Length 13 mm.; breadth 5 mm.

Several specimens were obtained.

*BATHYTOMA AGNATA, sp. nov.*

(Plate xxxvii., fig. 3).

Shell fusiform, biconical, solid, each spire whorl prominently

angled at its centre by a tuberculate keel. In the series before us the proportion of length to breadth varies considerably. Whorls eight, including a protoconch of a whorl and a half. Colour pale cream with an evanescent purple tinge in the aperture. Sculpture: the suture is slightly puckered by small radiating folds which run out before reaching half way to the keel. Along the keel are prominent wide spaced tubercles, numbering on the penultimate about seventeen, each truncated in front and sloping at the back to the base of its predecessor. Behind the aperture these sometimes degenerate into crowded imbricate scales. Below the keel the radial sculpture is resumed at indistinct forwardly curved riblets. Fine raised spiral threads extend from the tip of the canal to the protoconch. In the hollow supra-carinal shelf they are small and close together; below the keel, amounting on the last whorl to about forty, they are wider spaced, often alternating in size and tend to be knotted by the radials. Protoconch smooth and very glossy, dome shaped, a whorl and a half, ending with a sinus. Aperture narrow, perpendicular. Outer lip very deeply insinuate at the keel, then sweeping forward in a full curve. Columella broad, heavily calloused, excavate above, swollen and twisted below. Length 17 mm.; breadth 11 mm.

Several specimens from two hundred and fifty fathoms.

The lines of specific distinction appear to be drawn narrowly in this genus and to depend chiefly upon sculpture. The novelty appears intimately related to *Pleurotoma (Genotia) engonia*, Watson,<sup>5</sup> differing by the sharper keel, more elevated tubercles and generally coarser sculpture.

It was evident from literature that in size, shape and substance our species made a near approach to certain Tertiary forms named by Prof. R. Tate. We therefore sought the opinion of Mr. J. Denant on their inter-relationship, who very kindly replied, 14th March, 1906, as follows:—

“The *Bathytoma* submitted is allied to *B. pritchardi*, Tate,<sup>6</sup> from the Gippsland Miocene, and to *B. fontinalis*, Tate,<sup>7</sup> a common shell in the Oligocene beds at Spring Creek. From the first it is

<sup>5</sup> Watson—Journ. Linn. Soc., xv., 1881, p. 405; *Id.*—Chall. Rep., Zool., xv., 1886, p. 300, pl. xx., f. 7.

<sup>6</sup> Tate—Journ. Roy. Soc. N. S. Wales, xxvii., 1893 (1894), p. 175, pl. x., f. 4.

<sup>7</sup> Tate—*Loc. cit.*, p. 175, pl. x., f. 4.

distinguished by its sharper keels, plain sutures, and far finer ornament: and from the second by its less ornate keels, as well as by the convexity of the posterior sutural areas. Of the two remaining species in Victorian Tertiary strata, *B. decomposita*, Tate, has a much shorter spire, while *B. angustifrons*, Tate, is characterized by rounded keels and overlapping sutures. The recent species is thus easily separable from any of its fossil congeners."

TEREBRA LAURETANÆ, *Ten. Woods.*

(Plate xxxvii., fig. 9).

*Terebra lauretana*, Ten. Woods, Proc. Linn. Soc. N. S. Wales, ii., 1878, p. 262.

This unfigured species has hitherto been known only from a single specimen, the type now in the Australian Museum, which has ten whorls in a length of twenty millimetres. A fine specimen with sixteen whorls in a length of forty-one millimetres was taken in three hundred fathoms, and provided the material for the illustration now presented.

CANCELLARIA SCOBINA, *sp. nov.*

(Plate xxxviii., fig. 12).

Shell small, solid, biconical, tabulate, imperforate, rough sculptured. Colour grey (? bleached). Whorls five, including the protoconch, each with a broad concave shelf on the summit, perpendicular at the sides and contracted at the base. Protoconch papillate, smooth, a whorl and a half wound obliquely to the axis of the main shell. Sculpture: sharp crested wave ribs traverse the whorls obliquely, between and parallel to these are fine growth lines; on the last whorl the ribs amount to fifteen. The radials are crossed by spiral raised cords, which develop a tubercle at the passage of each radial, between each cord one or more raised threads. Aperture oblique, subtriangular. Columella with three plaits, the upper very oblique. Inner lip overlaid with a microscopically granular callus; outer grooved internally. Length 8 mm.; breadth 5 mm.

The new species can best be compared with a Port Curtis form provisionally identified as *C. australis*, Sowerby, than which the

novelty is less harshly sculptured, has a different protoconch, and is smaller in proportion to the number of whorls.

One dead specimen from three hundred fathoms, another from two hundred and fifty fathoms.

*CARINARIA AUSTRALIS, Quoy & Gaimard.*

*Carinaria australis*, Quoy and Gaimard, Voy. Astrolabe, Zool., ii., 1833, p. 394, pl. xxix., f. 9, 13; *Id.*, Smith, Challenger Rep., Zool., xxiii., 1888, pt. lxxii., p. 35; *Id.*, Vayssiere, Result. Camp. Scient. Prince Monaco, fas., xxvi., 1904, p. 22, pl. i., f. 11, 16; *Id.*, Verco, Trans. Roy. Soc. S. Austr., xxix., 1905, p. 171.

Our single specimen adds a genus and a species to the fauna of this State. After a lapse of more than seventy years, during which no examples were reported, it was retaken within a few weeks here and off the South Australian coast.

*AMUSIUM THETIDIS, Hedley.*

(Plate xxxviii., figs. 18 and 19).

*Amusium thetidis*, Hedley, Austr. Mus. Mem., iv., 1902, p. 304, f. 49.

No complete specimen of this species has been taken. Both the "Woy Woy" hauls produced a series of separate right valves, and on a right valve the species was founded. In their company appeared a series of separate *Amusium* left valves of corresponding size and shape, but of discrepant sculpture, one of which is here figured. In related forms the exterior of the right and left valves are differently ornamented, so pending the proof of attached valves, we accept these left valves as the missing halves of *A. thetidis*.

*LIMEA MURRAYI, Smith, sp.*

*Lima murrayi*, Smith, Proc. Zool. Soc., 1891, p. 444, pl. xxxv., f. 26.

*Limea acclinis*, Hedley, Rec. Austr., Mus., vi., 1905, p. 46, f. 10.

The figure of *L. murrayi* indicates radial ribs divergent along the median line, a feature not mentioned in the description. Partly in reliance on this, and partly prejudiced against the Australian habitat by the European species reputed to have occurred with it, *Linca acclinis* was distinguished as new. Having now recognised several of the "Challenger" 164 B mollusca and confirmed their Australian habitat, we would withdraw *L. acclinis* as a probable synonym of *L. murrayi*, and follow the description of the latter where it conflicts with the illustration.

LIMOPSIS ERECTUS, *sp. nov.*

(Plate xxxviii., figs. 14 and 15).

Shell small, solid, nearly equilateral, less oblique than usual, comparatively high and short. Colour white. Sculpture: about twenty concentric reverse-imbricating folds, the inner weaker and more wide spaced, crossed by faint radiating riblets. Small pits and interlocking tubercles are set round the inner bevelled margin but ascend only half way from the ventral edge. The teeth are disposed in two series, parted by a blank space, anteriorly about seven, nearly perpendicular, posteriorly about six, passing from oblique to horizontal. Area extremely deep, with a narrow median chondrophore. Height 4 mm.; length 3.7 mm.

The unusual depth of the area, and diverse inclination of the anterior and posterior teeth, differentiate this from other Australian species.

Two separate and worn valves from two hundred and fifty fathoms.

POROMYA UNDOSA, *sp. nov.*

(Plate xxxviii., figs. 16 and 17).

Shell small, oblong, moderately inflated, anterior end rounded ventral margin produced, posterior end rather square, dorsal margin rather straight. A low oblique wave ridge, preceded by a shallow hollow, runs from the umbo to the posterior ventral angle, where it projects. Umbo prominent, inflated, the space in front of it deeply excavate. Abrasions exhibit a smooth nacreous white shell beneath the thin pale yellow epidermis. The latter carries dense minute warts, increasing in size towards the margin,



and disposed in radiate and concentric lines. Interior brilliantly pearly, the muscle scars indistinguishable in our specimen. The inner ventral margin faintly minutely crenulated. Length 5·5; height 4·8 mm.

This appears to most resemble *P. cymata*, Dall,<sup>2</sup> from the west tropical Atlantic, than which it seems to be shorter, with a more feeble and oblique fold.

Two odd valves from two hundred and fifty fathoms, and fragments of larger specimens from three hundred fathoms.

---

<sup>2</sup> Dall—Proc. U.S. Nat. Mus., xii., 1889, p. 289, pl. viii., f. 4.

STUDIES IN AUSTRALIAN SHARKS, No. 3.

By EDGAR R. WAITE, F.L.S., Zoologist.

(Plates xxxix.-xli.).

CARCHARIAS BRACHYURUS, *Günther*.

(Plate xxxix.).

*Carcharias brachyurus*, Günther, Cat. Fish. Brit. Mus., viii., 1870, p. 369.

*Carcharias macrurus*, Ramsay and Ogilby, Proc. Linn. Soc. N.S. Wales, (2), ii., 1887, p. 163.

Dr. Günther's description was based upon a stuffed example, and under the circumstances, such plastic characters as the shape of the mouth and the snout can scarcely be regarded as affording reliable specific characters. Messrs. Ramsay and Ogilby, however, draw attention to these features as providing recognisable points whereby to distinguish a species described as new.

The omission of *C. macrurus* from my "Synopsis of the Fishes of N. S. Wales"<sup>1</sup> would indicate that I regarded this name as a synonym, an opinion strengthened by the examination of a specimen recently received in the flesh. This was forwarded from Lake Macquarie by Mr. James R. Rumsey, and is a female, 840 mm. in length. It is illustrated on the accompanying plate, which provides an accurate representation. Messrs. Ramsay and Ogilby describe the eyes as being rather nearer to the end of the snout than to the anterior gill opening; the former measurement was evidently taken round the curve of the snout, and yields a much longer line than can be shown in a profile drawing. The phrase "the space between the dorsal fins being rather more than one-third of the distance between the end of the second and the base of the caudal" is incorrect, and should read "the space between the dorsal fins is three times that between the second dorsal and the base of the caudal." The position of the anal is not mentioned in the description of *C. macrurus*: I find its

---

<sup>1</sup> Waite—Mem. N. S. Wales Nat. Club., No. 2, 1904, p. 7.

origin to be beneath the middle of the second dorsal while Dr. Günther describes it as being opposite to that fin.

This shark is locally known as the "Whaler," and the following account is by the late Mr. Edward S. Hill,<sup>2</sup> written over thirty years ago, when the species seems to have been commoner than now.

"This shark attains only in its adult state to the length of five or six feet; the mouth is of a crescent shape, armed underneath and around with three or four rows of sharp teeth, and the point of the nose is almost of a transparent substance; it is gregarious, and may be caught on a moonlight night, in the early part of the year, by the score, provided you have good tackle.

A boat was in search of the mullet one fine night, just north of the Sydney Heads, with a long and strong net, when the crew of fishermen saw what to them appeared a fine school, and shot round it; but, to their astonishment it was whalers, and they succeeded in hauling over one hundred and fifty of these sharks, averaging about five feet long.

In strong tide rips like that of Port Stephens, at the Spit in Middle Harbour, or on the shallows near the Sow and Pigs and off Heeny's Head in Botany, they are troublesome, and will bite off as many hooks as you please; they afford good sport when you are inclined that way and have good lines and hooks.

At Middle Harbour we were very successful when we went on purpose to fish for these sharks; then we had hooks protected with wire, and of a good size. The female when caught was frequently opened, to examine the ovaries and count the young sharks attached to the outside of each egg by the umbilical cord. These were three or four inches long, and the moment they were liberated would swim about and become a prey to the others.

The whaler at this season, and in such position, will take a bait of any kind pretty well, even in day-time, and pull tolerably strong, and depend on the sharp teeth to cut the line whenever they please. It is curious and interesting to see their manœuvres, endeavouring to get free when they are secured with good tackle. First they will run; then they will get their shoulder towards the line, so that they might cut it across with the corner of their mouth; this failing they will then have recourse to rolling, to try their main strength. However, as you continue to haul them in, they will unroll, and try every dodge to get loose, till a blow with

---

<sup>2</sup> Hill—*Sydney Mail*, 1874.

a club on the point of the nose quieters them. It is astonishing how easily they are stunned by a blow on that part; on any other place the same would have no effect."

#### EGG-CASES OF THE CAT SHARKS.

The two types of egg-cases illustrated on Pls. xl. and xli. are not uncommon on the coasts in the neighbourhood of Port Jackson, but so far I have not succeeded in determining to what species of Shark they respectively belong. The majority of the cases which I have examined have been cast-up on the beaches, empty. The few I have seen alive have had the embryos insufficiently developed to make determination a certainty. They doubtless belong to the Scyliorhinidæ, of which we have two members, assigned to the genera *Catulus* and *Parascyllium* respectively.



Fig. 38.

*Catulus analis*, Ogilby.

*CATULUS ANALIS*, *Ogilby, sp.*

(Plate xl., and Fig. 38).

*Scyllium anale*, Ogilby, Proc. Linn. Soc. N. S. Wales, x., 1885, pp. 445, 464.

*Scyliorhinus analis*, Ogilby, *loc. cit.*, (2), iv., 1889, p. 180.

*Catulus analis*, Waite, Mem. Austr. Mus., iv., 1899, p. 31, pl. ii., fig. 1.

This, the smaller of the Cat Sharks, attains a length of 570 mm., and to it I tentatively assign the egg-case illustrated on Pl. xl. The body of the case is comparatively long and narrow, maximum examples measuring 73 mm. in length and 25 mm. in width. The exact size and shape of a large specimen is depicted at fig. 38, and a contained embryo measuring 32 mm. in length, was developed only sufficiently to enable it to be identified as a member of the family. The plate shows an egg-case *in situ*, attached by its tendrils to a sea-weed (*Phyllospora comosa*). In colour, the egg-case of the Spotted Cat Shark is usually dark brown, though some specimens are much lighter in tint.

PARASCYLLIUM COLLARE, *Ramsay & Ogilby.*

(Plate xli.).

*Parascyllium collare*, Ramsay and Ogilby, Proc. Linn. Soc. N. S. Wales, (2), iii., 1888, p. 1310; Waite, Mem. Austr. Mus., iv., pl. ii., fig. 2.

The Collared Cat Shark reaches larger dimensions than the fore named species, attaining the length of 825 mm. The egg-case, which I believe to be of this species, is of considerable capacity, measuring 73 mm. in length and 38 mm. in breadth, and is light horn-colour in tint. The illustration shows its shape very well, and represents an example trawled on the "Thetis" Expedition in 1898, and obtained at a depth of 63-75 fathoms off Port Kembla. Another living egg was trawled off Botany Bay in 79-80 fathoms. The former specimen is attached to a Gorgonia (*Plumarella penna*, Lamarck), and contained an embryo measuring 43 mm. in length.

I take this opportunity of correcting an error in the explanation of the plate, published in the Memoirs of this Museum and quoted above. "Fig. 2. Male, three-fourths natural size," should read "less than one-fourth natural size."

ON A VARIETY OF *GOURA CORONATA*.

By ALFRED J. NORTH, C.M.Z.S., Ornithologist.

While the Curator was engaged in re-arranging the foreign bird collection, he brought under my notice a mounted specimen of *Goura coronata* which was entirely different from another typical example of this species in a different part of the case. The specimen under consideration is in markings and size similar to the well-known form of Crowned Pigeon, but almost the entire plumage, except the white wing-speculum and apical tail-band, had a distinct blackish wash, only a few small places about the head, breast, wings and tail revealing here and there the bluish slaty-grey plumage, the chestnut tips of the upper wing-coverts and band across the back, also being much darker. The locality of the specimen is unknown, and after a careful comparison I concluded it was a melanistic variety of *Goura coronata*. Subsequent research by the Assistant Taxidermist revealed another skin in the foreign collection. This specimen was received in 1897 as a donation from the Director of the Botanic Gardens, Sydney, the habitat recorded in the register as Java, being undoubtedly erroneous. With the exceptions pointed out in the mounted example, the remainder of the plumage may be described as deep sooty bluish-black including the head and crest plumes. The only indications of the normal bluish slaty-grey plumage of *Goura coronata*, may be seen in some places on the quills and tail feathers. It measures—Total length 24·5 inches, wing 12·75, tail 9·2, exposed portion of bill 1·3, tarsus 3·5, and is distinctly smaller than typical examples of *Goura coronata*. Whether the dark plumage is due to climatic influence, confinement, or typical of a distinct species, I am unable to say, but I purpose to distinguish the latter specimen under the name of *Goura coronata*, var. *nigra*.

## OCCASIONAL NOTES.

---

### IV.—CRUSTACEA NEW TO AUSTRALIA.

Anyone studying the Australian marine fauna must be struck with the large number of species, originally described from Japan, which have been traced south through the East Indian Archipelago and eventually recognised from Northern and Eastern Australia.

Examples of two such species, hitherto unrecorded from the latter region, have been acquired by the Trustees. The first is a beautiful specimen of *Lambrus validus*, de Haan, the carapace of which is 40 mm. in length, and was presented by Mr. Thomas Temperley, who collected it at Dalmer Island, in the estuary of the Clarence River, N. S. Wales. From Japan, the original habitat, the range of this species was extended by Bleeker<sup>1</sup> to Sumatra.

Again, a fine beach-dried example of *Scyllarus sieboldi*, de Haan, measuring 410 mm., was obtained from Lord Howe Island. It has been observed, according to Dr. A. Ortmann,<sup>2</sup> in Japan, the Arn Islands and Amboina, so the present record extends its distribution southward by about one thousand and five hundred miles.

ALLAN R. McCULLOCH.

---

<sup>1</sup> Bleeker—Act. Soc. Indo-Néerl. Batavia, ii., 1857, p. 17.

<sup>2</sup> Ortmann—Zool. Jahrb., vii., 1895, p. 4 5.









12,351

RECORDS  
OF THE  
AUSTRALIAN MUSEUM.

EDITED BY THE CURATOR.

---

Vol. VI., No. 4.

---

PRINTED BY ORDER OF THE TRUSTEES.

R. ETHERIDGE, JUNR., J.P.,

Curator.

SYDNEY, JANUARY 23, 1907.

## CONTENTS.

	PAGE.
Aboriginal Workshops on the Coast of New South Wales, and their Contents. By R. Etheridge, Junr., and Thomas Whitelegge ...	233
On the Oligochaeta from the Blue Lake, Mount Kosciusko. By W. B. Benham, D.Sc. M.A. ... ..	251
Mineralogical Notes: No. IV.—Orthoclase in New South Wales. By C. Anderson, M.A., B.Sc. ... ..	265
The Results of Deep Sea Investigation in the Tasman Sea. I. The Expedition of H.M.C.S. "Miner."	
1. Introductory Note on the First Deep-Sea Cruise. By W. A. Haswell and C. Hedley ... ..	271
2. The Colonial Radiolaria of the Tasman Sea. By Prof. W. A. Haswell, M.A., D.Sc. ... ..	273
3. Mollusca from Eighty Fathoms off Narrabeen. By C. Hedley, ... ..	283
4. Foraminiferal Sand Dredged Twenty-two Miles east of Sydney at a Depth of Eighty Fathoms. By E. J. Goddard, B.A., B.Sc. ... ..	305
Note upon <i>Mus tomponi</i> , Ramsay. By Allan R. McCulloch... ..	312
Two New Species of <i>Collembola</i> . By W. J. Rainbow ... ..	313
Occasional Notes—	
V.—The Generic Name <i>Crepidogaster</i> . By E. R. Waite ... ..	315
VI.—Note on an Unusual Set of Stoneplover's Eggs. By A. J. North... ..	315

ABORIGINAL WORKSHOPS ON THE COAST OF NEW  
SOUTH WALES, AND THEIR CONTENTS.

By R. ETHERIDGE, JUNR., Curator, and THOMAS WHITELEGGE,  
Senior Zoologist

*Records of the Australian Museum*, vol. vi., pt. 3.

ERRATA.

P. 204, for fig. 1 read fig. 2 (*D. cardinalis*).

P. 205,           "                   "                   "

Explanation of Plate xxxvi.—

Fig. 2 read *Diplocrepis cardinalis*.

Fig. 4 read *Crepidogaster (Aspasmogaster) spatula*.

Transpose figs. 6 and 7.

of small weapons and implements of various kinds on the South Australian sea-board, but there is no indication as to whether these stone implements were found scattered over the surface generally or derived from "workshops." The instruments are

---

<sup>1</sup> Etheridge—*Rec. Austr. Mus.*, iv., 4, 1900, pp. 148 and 165.

<sup>2</sup> Howchin—*Proc. Austr. Assoc. Adv. Sci.*, v., 1893, p. 522.

1871  
1872  
1873

ABORIGINAL WORKSHOPS ON THE COAST OF NEW  
SOUTH WALES, AND THEIR CONTENTS.

By R. ETHERIDGE, Junr., Curator, and THOMAS WHITELEGGE,  
Senior Zoologist.

(Plates xlii.-xlv., and figs. 39-43).

I.—INTRODUCTION.

A preliminary account of this subject appeared in the Curator's Report for 1900.<sup>1</sup> The report reads as follows:—"A very remarkable discovery was made by Mr. T. Whitelegge in the early part of the year, along the local sea-board. A series of heavy gales displaced the sand hummocks at Bondi and Maroubra Bays, Dee Why Lagoon, etc., exposing what appeared to be an old land surface. On the latter Mr. Whitelegge found revealed, what we had never before imagined to exist, a series of aboriginal 'workshops' where for generations the blacks of the Port Jackson District must have manufactured chips, splinters and points for insertion along the distal margins of their spears and for other purposes. The old land surface at Bondi, as I saw it, in company with the discoverer, was covered with thousands of these chips, some of them exquisitely made, with core pieces, chippers and rubbers. The lithological character of the material used was very varied, from pure white crystalline quartz, opaque amorphous quartz, every variety of chert and quartzite, to rocks of a metamorphic character. It is quite clear that the siliceous material was derived in a great measure from the surrounding Hawkesbury Sandstone, but the others were probably obtained from distant sources. I regard this as one of the most important ethnological discoveries made in New South Wales for many years."

Mr. Walter Howchin<sup>2</sup> appears to have discovered a large number of small weapons and implements of various kinds on the South Australian sea-board, but there is no indication as to whether these stone implements were found scattered over the surface generally or derived from "workshops." The instruments are

<sup>1</sup> Etheridge—*Rec. Austr. Mus.*, iv., 4, 1900, pp. 148 and 165.

<sup>2</sup> Howchin—*Proc. Austr. Assoc. Adv. Sci.*, v., 1893, p. 522.

enumerated as follows :—(1) Stone points ; (2) Flakes (knives), in seven varieties of single-edged, ridged, flat and polygonal, lanceolate, broad, serrated and trimmed ; (3) Spearheads of a type which seems to be restricted to a narrow coastal belt ; (4) Chisels ; (5) Gouges ; (6) Awls ; (7) Scrapers, divided into eleven distinct varieties ; (8) Hammers ; (9) Anvils ; (10) Fabricators ; (11) Cores.

Mr. Brough Smyth<sup>2</sup> gave the following account as to the use of stone implements :—“The Western Australians use small splinters of quartz for making the long deep cuts which may be seen on almost every native—both men and women—across the breast and arms, with a similar fragment stuck to the end of a stick they dress and cut their kangaroo skins in preparing them for use as cloaks. They also stick thin splinters of quartz, broken by their teeth, to the side of a short stick to serve as a saw.”

## II.—DESCRIPTION OF LOCALITIES.

During the early part of the year 1899, in wandering over the northern end of the sandhills at Maroubra, the attention of one of us (T.W.) was attracted by sundry flint chips. Having found many flints of various kinds on the Lancashire and Yorkshire moorlands, these flakes were at once recognised as having been made by man. On reaching the summit of the sandhill, a strange feature presented itself, instead of the usual bare waste of sand, the whole surface was studded with butts of *Banksia* trees two or three feet high, and one or two feet in diameter. The intervening spaces were covered with a scrubby growth, consisting of the stems and roots of various plants, many of which were standing *Pandanus*-like, having the roots covered with lime from a quarter to half-an-inch thick. Whilst the interiors of the lime tubes were lined with a thin cylinder of bark, in other parts the bark cylinders were standing alone without the calcareous envelope. The whole area appeared like a miniature skeleton forest, of black and white stems and roots.

The ground between was strewn with thousands of stones that had been used by the Aborigines for some purpose or other, and had all been taken to the top of the sandhills, many of the stones being quite foreign to the district. Here would be found a patch of black flint chips about a yard in diameter, there another of red or yellow jasper, just as if the native artist in stone-working

---

<sup>2</sup> Brough Smyth—Aborigines of Victoria, ii., 1878, app., p. 520.



had only left the ground a few minutes before. In fact this was an aboriginal "workshop" from which the workers may have disappeared hundreds of years ago.

After a thorough survey of the ground all the smaller instruments available were carefully collected, the larger heavy instruments being gathered and duly interred to be attended to on some future occasion. The weapons collected were very valuable, including tomahawks, grindstones, a nose ornament, knives, scrapers, graters, drills, and spear points such as were used for fighting or "death" spears, and lastly a very peculiar lancet-like surgical knife or scarificator. The latter is one of the most interesting of the finds inasmuch as instruments of the same shape have been found in America, India, England, and Ireland, and in the latter country they were met with on the tops of the sandhills just as we saw them at Maroubra and Bondi.

The "workshops" at Bondi were far more extensive than those at Maroubra, the whole length of the back of the beach was more or less covered with tons of stones, all of which had been taken there and put to some use. In the centre of the beach there was a kind of delta upon which the coarser materials were deposited, the sand having been washed away on this area; thousands of implements, which had evidently been used, were found, and chips or flakes were few and far between. For many months the original ground at Maroubra, and also the more extended area at Bondi, yielded an abundance of implements and at each visit we invariably returned with as much as we could carry. Unfortunately the new road across Bondi has now covered most of the sites that afforded the best ground for collecting. Still there are a few patches left at Bondi, which after certain gales would be well worth visiting; the same remarks apply equally well to Maroubra and other places.

The workshops exposed at Rocklily, Dee Why, and other places north of Manly, are very small and patchy, the northern end of Curl Curl Beach is generally good ground to collect on after a strong north-east wind, but otherwise there is scarcely anything but sand. During our researches one of us (T.W.) visited Newcastle, but with little result; the most likely place on this extensive beach would be the end of Stockton Beach towards Port Stephens.

A few stone implements were found at Botany Bay and at Kurnell, but there does not appear to be any extensive accumulations at these places. The northern end of Cronulla Beach is

extremely rich in stone weapons, chips and flakes. It is covered with many mounds of oyster and other shells, some of which are nearly a hundred feet or so in height. The whole surface in addition to the shells is sprinkled with chips, flakes and weapons, and many of the best found were obtained on or near the base of these oyster mounds. Some distance to the south of the latter there exists a series of extensive flats and hummocks more or less covered with pumice stone. On this ground a large number of implements were found, all of which had evidently been used, but there was an absence of chips or flakes, such as are usually present on the "workshop" grounds.

A few worked implements accompanied by chips and flakes have been met with on several wind-swept sandy patches on the Waterloo Swamps between Kensington and Bourke Street, Redfern.

During a short stay at Mr. Mark Foy's Valley Farm, Kanimbla Valley, Medlow Bath, Blue Mountains, one of us (T.W.) found the soil on the escarpment slopes, as well as on the flats and the banks of the creeks, more or less charged with chips, flakes, and many worked implements, among which were numerous examples made of white quartz, the latter exhibiting very distinct chipping, in a manner more perfect than in any instruments of quartz previously found.

During our researches traces of minor "workshops" which yielded various weapons, chips, flakes, and other objects of interest were found at Gerringong, Redhead, Ulladulla and Milton on the South Coast. There is also evidence of a large "workshop" on the southern end of Wollongong Beach, a little distance from the racecourse stand. The most extensive "workshop" met with, however, is situated at Bellambi Beach (Pl. xlv.). This area is many acres in extent, and is more or less densely strewn with stones of all descriptions, at least such as are usually found on shell heaps, camping grounds or workshops. Of the larger stones observed, many consisted of irregular pieces of sandstone (fire stones?), fragments of siliceous fossil tree stems, oval or rounded flattish boulders, probably used as grindstones for pounding seeds, others of the same shape but smaller, or such as were suitable for the manufacture of tomahawks. The latter were very numerous, and also other thicker stones frequently with central pits as if they had been used as anvils for cracking large seeds or fruit-stones on.

The smaller stones fit for use were present in vast numbers, and consisted for the most part of waterworn pebbles, more or less egg-

shaped. They are very variable in size and also in composition ; a large number of them had already been tested as to suitability for cores or from which instruments had been manufactured. The rest of the ground was covered with innumerable chips, flakes, cores, together with a fair sprinkling of carefully-worked weapons, as well as others upon which much labour had evidently been expended, and yet through a flaw in the stone, or want of care or skill on the part of the operator, proved to be “wasters.”

There is ample evidence that many of the sand dunes were at one time much higher than they are now, and also that in some parts they had been covered with vegetation interspersed with native camping grounds, upon which vast quantities of shells were deposited : in course of time the vegetation was covered by sand drifts, other shell heaps formed at the summit, and the whole again buried. The period of time required for these various changes must have been very great, and it has required a still greater lapse of time to produce the present condition. The shells, probably owing to the rainfall, have in many instances been dissolved and the constituent lime deposited around the roots and stems of the plants which lived on the surface. Many instances proving the correctness of the views as above related may be seen on the coast at Maroubra and Bondi, but more especially at Cronulla and Bellambi. In other spots the beds of shells are still visible, but in various stages of decay, either having been accumulated more recently or protected by thick layers of black soil and covered with vegetation. The edges of some of the sand cliffs at Cronulla, Maroubra and Bellambi afford many sections illustrative of the above remarks. These cliffs are gradually being denuded by the action of the wind, and constant falls are taking place, leaving the shells and stones either at the foot of a cliff or around the base of some large mound on which vegetation, soil and other shells and stones are still *in situ*. The sand and soil are then rapidly blown away, leaving the shells and stones scattered about the surface : a gale from one quarter will cover the area, and windy squalls from another will lay it bare.

### III.—DESCRIPTION OF THE IMPLEMENTS AND WEAPONS.

The various stone implements obtained from the “workshops, camping grounds, kitchen-middens, and alluvial deposits will now be described in the order of importance as exhibiting flaking, chipping, or skill in manipulation. Opinions as to the uses of the implements, with a few exceptions, must be taken as speculative.

In some instances the use to which any given manufactured stone implement was put is known from the fact that observers both in Australia, America and elsewhere have seen the natives using the instruments for various purposes of daily life. Other stone implements which no doubt were largely used by the Aborigines are difficult to define, and we can only surmise as to what use they were put. Recent weapons and implements, such as are now made in Northern and Western Australia, afford a clue to the uses of these carefully-prepared stone tools or weapons, and also illustrate how the smallest fragments of flint or quartz were fully utilized in the manufacture of fighting or "death" spear barbs, saws, surgical lancets, gouges, etc.

NO I.—PLATE XLII., GROUP 2.

The most important instrument from an Ethnological point of view is what we would prefer to call chipped-back surgical knives (fig. 39). Various authorities have figured and described them,



Fig. 39.

but so far as we can gather they have never been found in such quantities as obtained on the coast of New South Wales. The most remarkable feature in connection with these instruments is their more or less uniform shape, irrespective of size. The thick worked back is generally curved, and in section is cuneiform or triangular: the thin cutting edge is usually sub-crenate, sometimes straight but rarely convex. Judging both from the unfinished and perfect instruments they were manufactured from pebbles about the size of a duck's egg; the stone would be divided transversely in the middle and the instruments struck off from each half. As to the working or chipping, it is impossible to say whether this was done before or after the formation of the implement, but from the fact that numerous similarly-shaped instruments have been found with, perhaps, a broken point, which do not exhibit any chipping, we are inclined to the opinion that the thick convex part of the instrument was worked after the flake of the requisite shape had been obtained. So far as the cutting edge or point is concerned, there is no evidence revealed in the instruments of chipping or grinding, as the original sharp edges and points have not been interfered with in any way. As regards

size the instruments vary greatly, the largest obtained is about 50 m.m. in length, 10 m.m. in breadth, and 7 or 8 m.m. in thickness; the smallest measures 10 m.m. in length, 5 m.m. in breadth, and 2 to 4 m.m. at the delicately carved back.

The lithological character of the stone used in making these implements is extremely variable, viz., quartzite, fossil wood, white chert, black flint, red and yellow jasper, and other siliceous materials, most of which were from places remote from the metropolitan district; shell was occasionally employed (fig. 40). To what use these knives were put, we can only surmise. It seems probable that the Australian Aborigines have ceased to manufacture this form of lancet at the present day—at least from stone. Neither Prof. W. B. Spencer or Dr. W. E. Roth had any knowledge of such implements from any part of Australia



Fig. 40.

The literature relating to these knives is scanty, and so far only one authority has been found who gives a definite statement as to their use, all the rest of the opinions, including those herein expressed, being purely speculative.

Under the title of "Minute Stone Implements from India,"<sup>4</sup> Dr. Thomas Wilson figures and describes knives which are identical in every particular with those found so abundantly on the sand-dunes along our coast. It is also remarkable that the implements are similar in lithological characters; they were "found in the caves and rock-shelters amongst the Vindhya Hills, in places difficult of access and unknown to the ordinary traveller." The author states that "the similarity of form and mode of manufacture . . . is evidence showing the same intention on the part of the makers, although we are quite in the dark as what that intention was. . . . It is not easy to determine the purpose of these small implements, especially the crescent, trapezoid and scalene triangular, which have neither known prototype or antitype; some of the smaller and straighter objects might have served as needles or perforators. A possible use akin to that

<sup>4</sup> Wilson—Ann. Report Regents Smithsonian Inst. (U. S. Nat. Mus. Report) for 1892 (1893), p. 455, pl. cii.

of tattooing might have been that of the medicine man for bleeding or scarifying.<sup>5</sup>

The same author in a paper on "Arrow-points, Spearheads and Knives of Prehistoric Times,"<sup>6</sup> figures several flaked stones which have a strong resemblance to those he describes from India; we refer to Pl. vii., figs. 6 and 9 from Lake Biemme, Switzerland; Pl. xxv., fig. 29 from the island of Crete, and Pl. xxxix., figs. 2 and 3.

The best account to come under our notice of these peculiar instruments is that given by Mr. W. K. Moorehead in his "Prehistoric Implements."<sup>7</sup> Under the heading of "Scarificators.—Delicate Splinters of Flint,"<sup>7</sup> he gives a description of the finding of the instruments in burial places on Santa Rosa Island and San Nicholas Islands. About a quart of these implements was obtained. "They were finely made of yellowish-brown jaspery or flinty rock. They were all together when found, having evidently been buried with their former owner. Not finding any other specimens in our extensive explorations, extending over a period of three weeks search for relics, I was convinced that they were not objects of general use, but were part of the paraphernalia of a medicine man among the natives, and that their manufacture required the exercise of unusual skill, and would only be made by certain individuals of the tribe possessing the necessary qualification. Some ten years after the discovery I had the opportunity to interview some of the few representatives of the former aborigines, and from them learned their uses. They said they were used by the medicine men in the cure of disease, by scarifying the skin over the affected part, and applying one end of a bone or stone tube over . . . the scarified parts and exhausting the air from the tube by sucking applied by the lips of the operator, thus causing blood to be drawn from the wounds made by these splinters. . . . Hugo Reid says of the Indians of Los Angeles county, that local inflammation was treated by scarifying with pieces of sharp flint and procuring as much blood as possible from the part. (See *Overland Monthly* for August, 1896)."

<sup>5</sup> Wilson Ann. Report Regents Smithsonian Inst. (U. S. Nat. Mus. Report), for 1897 (1899), pt. 1, p. 811.

<sup>6</sup> Moorehead—Prehistoric Implements, Cincinnati, Ohio, 1900.

<sup>7</sup> Moorehead—*Loc. cit.*, p. 246, fig. 379 (p. 247).

Considering the similarity of these instruments, both as to their uniformity in general shape, flaking and lithological characters, it may be inferred that they were used as surgical lancets, and in the hands of a skilful medicine man might be used for purposes other than those enumerated above, such as "crimping" the skin of the arms, chest and back, to form the numerous cicatrices so frequently seen on the bodies of the Australian Aborigines.

A large flaked-back knife is figured by Sir John Evans,<sup>8</sup> from Australia, which differs little from the smaller instruments, the only points of difference being the size and the convex cutting edge, which is rarely the case in those herein described. The knife may be more useful in producing the larger cicatrices, but the smallest kind might also be employed for the lesser tribal marks, etc.

Very similar objects have been found in Britain, although of rather larger size. Evans<sup>9</sup> figures four, two of which at least, from Newhaven and Seaford, respectively, are very like indeed. Rather similar chips are also figured by Brough Smyth<sup>10</sup> as used for this purpose. We are informed by Mr. E. Bonney<sup>11</sup> that in the Bungyarlee and Parkungi tribes of the Darling River, stone chips called *carnee moolee* were actually used to produce the cicatrices, or raised scars, known to these tribesmen as *wincka*; other similar references could be given.

#### NO. II.—PLATE XLII., GROUP 1.

The second group contains many knives of various shapes and sizes, some of which are neatly flaked or chipped, so as to produce a fine sharp edge, but the majority were flaked from the core in such a perfect condition as to cutting edge, that secondary chipping was not required, and were evidently satisfactory to the maker.

#### NO. III.—PLATE XLIV., GROUP 5.

Large series of implements, probably scrapers of a peculiar pattern were obtained, which are invariably carefully chipped on one or both surfaces; they are more or less lenticular in shape and

<sup>8</sup> Evans—*Ancient Stone Implements, Weapons and Ornaments of Great Britain*, 1872, p. 264, f. 198.

<sup>9</sup> Evans—*Loc. cit.*, p. 251, figs. 190-193.

<sup>10</sup> Brough Smyth—*Loc. cit.*, i., p. 381, figs. 208-9.

<sup>11</sup> Bonney—*Journ. Anthropol. Inst.*, xiii., 1884, p. 126.

some portion of the periphery generally presents a sharp cutting edge. As to the use of this particular form of instrument, little is known. Wilson in his "Arrow-points, Spear-heads and Knives of Prehistoric Times,"<sup>72</sup> gives a short description of these small flaked implements, and on Pl. xii. he figures about thirty-six specimens which are practically identical with the Australian examples depicted (Pl. xliv., Group 5).

Dr. Wilson gives an interesting account of the discovery of a scraper "workshop" on the west coast of Brittany, France. Working in company with M. Gaillard, a visit was paid to the extreme point of the promontory of Quiberon. Here "a high rocky point level with the surrounding surface, but forty or fifty feet above the water. It was severed from the mainland by a crevice a few feet in width passable only at low tide. The entire mass was of granite rock. It was covered by a layer of soil which was nearly bare on the ocean side, but on the inside edge it was three-and-a-half feet thick. Beginning at the outside edge by screening, examining, and throwing the dirt behind us, bits of broken and wrought flint and fragments of pottery were soon found. We saved everything. Our work continued across the point until we had thousands of objects, principally scrapers in all stages of manufacture. It was a prehistoric scraper 'workshop. The peculiarity of these were their diminutive size: many perfectly finished were no larger than a man's thumb nail. At the edge farthest from . . . the ocean we unearthed the skeleton of a workman, a man of middle age, he who probably had made these prehistoric implements, who had here lived and had here died, and had been buried in his workshop and habitation." In size the Australian worked scrapers agree with those above described.

Brough Smyth<sup>13</sup> figures a chip for skinning, etc., dug out of a *mirryony* heap, with some relation to those of the present group, but our coastal chips are much more highly flaked, and usually with a central ridge.

#### NO. IV.—PLATE XLIII., GROUP 1.

Another instrument (fig. 41) which often displays chipping, flaking and notching, was found in great numbers. The shape is

<sup>12</sup> Wilson—Ann. Report Regents Smithsonian Inst. (U.S. Nat. Mus. Report) for 1897 (1899), pt. i., p. 867.

<sup>13</sup> Brough Smyth—*Loc. cit.*, i., p. 382, fig. 217.





Fig. 41.

pretty uniform, but in size they are very variable. They are generally oblong with the bases truncate and the apices more or less rounded by chipping, the lateral margins usually have clear cut sharp edges just as if they were flaked from the core, but in some instances secondary chipping has been resorted to, to make the requisite sharp edge on one or both sides. In the majority of specimens the sides are notched so as to produce a series of saw-like teeth, fine on one side and coarse on the other. There is little doubt that these implements were used as gravers, by the aid of which the elaborate line work was made on boomerangs and other weapons. One of us<sup>11</sup> in 1890 gave a full and definite account as to the use of this class of implement which has often been figured from many parts of the world. The evidence as to the purposes to which these instruments were put was from a reliable eye-witness.

In the description it was stated that "the two chips exhibited were given to me by Mr. George Sweet, of Brunswick, Melbourne, who saw them used by 'Jerry,' of the Telebra Tribe at Marathon, Central Queensland, to produce the indented lines ornamenting wooden weapons. They are composed of a black brecciated chert, with glossy lustre, and a subconchoidal fracture, but appear to have been fortuitous fragments chipped from larger masses, and more or less triangular in form. Mr. Sweet informs me that the chips are held tightly between the fingers of the right hand, the weapon to be worked reposing on the left, and supported by the left arm. The chip is then used as a chisel, the carving, in the practiced hand of the black, proceeding with great rapidity." The specimens figured on Pl. xliii., Group 1, will fully prove these gravers are not "fortuitous fragments," as at first supposed, but implements that have been deliberately manufactured for a definite purpose.

Judging from the instruments generally, apart from the triangular form, they appear to be usually adapted for use by the index finger and thumb: the truncated base is somewhat oblique and well calculated to afford a firm hold when applied to the fleshy part of the thumb; the rounded apex also forms a surface

<sup>11</sup> Etheridge—Notes on Austr. Aboriginal Stone Weapons and Impl. (Proc. Linn. Soc. N. S. Wales, v., 1890, p. 367, f. 13).

around which the index finger can be slightly bent, and thus provide a firm grip of the tool when in use.

No. V.—PL. XLII., GROUP 3.

Included in this group are a number of straight, slender points, with clean cut edges, and devoid of any secondary working; they are generally more or less triangular in section in the distal two-thirds, while the proximal third has been flaked off, so that in section they are four-sided.

No. VI.—PL. XLII., GROUP 4.

There are a number of instruments generally shaped like spear-heads or arrow-points, frequently triangular in outline, mostly longer than broad, and sometimes elongate. It is difficult to conjecture what they were used for, but it appears highly probable that most of them were intended to be mounted on the end of a short handle of wood, the larger kind forming a short spear and the smaller being used as knives, drills, skinners, or perhaps even for shredding bark fibre. They are mostly clean cut, and secondary working is evident only in the form of small notches on one or both margins.

No. VII.—PL. XLIV., GROUP 2.

By far the most abundant objects obtained were flakes resembling those formerly, and still, used for making one form of barbed spear. Although mere flakes, without any trace of secondary chipping or flaking, these implements, when well made, have usually a very definite character, irrespective of their size or exact contour, and are very neat in outline.

The most perfect forms are triangular in outline, the basal part is thick and often elongate centrally, at least on one side; in many examples there is a longitudinal ridge, and from the latter the surface slopes away to the lateral margins. One or both edges are extremely thin, and, in many specimens, often jagged in outline; the edge on one side is thick or blunt, or the stone may be flaked a little to produce a non-cutting edge. Apart from the well-formed barbs there are many thin flakes which were used for the same purpose. The implements were manufactured in great numbers as barbs for the fighting or "death" spear, which had a shaft eight or ten feet long, and the terminal or distal portion grooved on one or both sides, the grooves starting at a short distance from the point of the spear for about

eighteen inches backwards. The stones above described are inserted in the grooves with the base downwards and the thin cutting edge directed forwards, while the blunt edge, if present, is directed backwards: the stones were selected according to size, the smaller being placed near the tip of the spear, and the whole cemented into the grooves, leaving about two-thirds of the barbs projecting. It appears highly probable that the blunt-edged barbs are designed to prevent the extraction of the spear without leaving some of the chips in the wound.

As illustrating the use of the "death" spear, Collins<sup>15</sup> supplies the following account of a man who was employed to shoot game for Governor Phillip. He states that "on the tenth of December a convict employed by Governor Phillip to shoot for him was dangerously wounded by a native named Pe-mul-wy whilst in quest of game at some considerable distance in the woods. When brought in he declared, and at a time when he thought himself dying, that he did not give any offence to the man who wounded him; that he had even quitted his arms to induce him to look upon him as a friend, when the savage threw his spear, at a distance of about ten yards, with a skill that was fatally unerring. When the spear was extracted (which was not till suppuration took place) it was found to have entered his body under the left arm to a depth of seven-and-a-half inches, and was armed for five or six inches from the point with ragged pieces of shells fastened in with gum. His recovery was pronounced by the surgeon to be very doubtful. . . . On the twenty-second the man employed to shoot for the Governor expired of the wound he had received from the native. On opening the spear appeared to have wounded the left lobe of the lungs, which were found adhering to the side. In the cavity were discovered some of the pieces of stone and shell with which the weapon had been armed." Other cases as to the fatal effects of the death spear are on record, but unfortunately at the moment of writing the exact references cannot be given. It is rather singular that the aboriginal inhabitants of Sweden should have used a barbed arrow-head (fig. 42) of the same type as the spear formerly used by the natives of the Port Jackson District, and which is still manufactured by the blacks in West and North Australia. The only difference between the two weapons is that the Swedish arrow-head (fig. 42) was made of bone as far as the apical portion was concerned,

---

<sup>15</sup> Collins—Account of the English Colony of N. S. Wales, 1804, pp. 118 and 123.

whilst the Australian examples were of wood. The flakes or barbs used, however, appear to have been the same, and any jagged fragment of suitable size was used to fix into the grooves of this fatal form of spear.

The following quotation from Wilson's<sup>16</sup> "Arrow-points, Spear-heads and Knives of Prehistoric Times," is of interest:—"Fig. 191 is one of the peculiar forms restricted in number and locality. Its restrictions in both these regards are so close that the author has not deemed it necessary to assign it a class or give it a name. These forms are confined to Scandinavia and are extremely rare even in that country. The specimen figured is from Sweden, was procured by the author and forms part of the collection in the U.S. National Museum. It is an arrow-point of bone (fig. 42), sharpened to a fine point, is extremely hard and stiff, and could pierce equal to any flint weapon. Either side is opened with a deep and narrow groove, into which have been inserted tiny bits of flint flakes, with sharp cutting edges, fastened with bitumen or gum. Some of these bits of flint have been lost out of the original specimen, but enough remains to show its character and effectiveness as a weapon." It may be that this particular arrow had been used and the missing chips left in the body of some unfortunate victim.



Fig. 42.

Figures and casual references to the stone-barbed or "death"-spear are fairly numerous, but little information is available as to their manufacture or method of use by the natives. Considering the natives of West and North Australia still make and use these spears, often substituting glass splinters, it would be advisable for travellers, prospectors and others to make notes on this weapon before it is too late.

Collins figures one of these barbed spears, he also gives engravings of groups of natives, and some seven full paged plates are

<sup>16</sup> Wilson—Am. Rep. Regents Smithsonian. Inst. (U. S. Nat. Mus. Report) for 1897 (1899), pt. i., p. 943, fig. 191.

illustrated and in every case the "death"-spear is depicted in the hands of the aborigines. The majority, judging from the figures, are barbed on one side only, but many are armed on both edges.<sup>17</sup> The "Saturday Magazine" contains some account and a figure of one of these barbed spears. The writer signs his "Sketches of New South Wales"—W.R.G. [Surveyor Govett]. His description of the spear under notice is as follows:—"Their spears are generally from ten to twelve feet in length, frequently longer: some consist of one, others of two, and the longest of three distinct pieces, which are chiefly made of 'iron-bark' wood. In the longest the centre bits are made of the grass tree, which grows like a tall straight reed, and seems very well suited for the purpose of a spear. Some spears are hooked and jagged, and since the natives have become acquainted with glass, they have taken advantage of that material, by cementing the broken sharp splints of it, which are made to jut out from the top of the spear like the points of lancets, as a substitute for their common way of jaggling."

An excellent figure (fig. 43) of the "death"-spear is given by Brough Smyth.<sup>19</sup> He states that "the *Moungile*, a double-barbed spear, is one with which cruel wounds are inflicted. If it strikes a black fairly, it will enter quite up to the lower barb, and it can be extracted only by cutting open the wound and drawing it through. . . . A hard and tough wood is used for making spears of this kind. With a piece of quartz the native cuts a groove on each side of the upper end, and he inserts therein small chips of hard black basalt, or chips of some other suitable stone, and these chips are fastened in their place by *Pid-ger-ong*, a gum resembling pitch." Brough Smyth also figures<sup>20</sup> individual chips of black basalt used for this purpose.

The following includes a few further references to this spear. The Rev. G. Taplin<sup>21</sup> states that "they make their weapons of the hard wood which grows in the country. Heavy spears generally come from the Upper Murray natives, and are highly valued. They are made of the hard and elastic miall wood, and are



Fig. 43.

<sup>17</sup> Collins—Account of the English Colony of N. S. Wales, 1804, p. 455 pls. 1-7., particularly pl. 4 (pp. 367-74)

<sup>18</sup> Govett—*Saturday Magazine*, 4th June, 1836 (No. 252), p. 217, and 15th Oct., 1836 (No. 275), p. 156, fig.

<sup>19</sup> Brough Smyth—*Aborigines of Victoria*, i., 1878, p. 304, f. 68.

<sup>20</sup> Brough Smyth—*Loc. cit.*, p. 380, figs. 202-7.

<sup>21</sup> Taplin—*Native tribes of S. Australia*, 1879, p. 40.

formidable weapons. Some of the spears made by the Narrinyeri are barbed with spicules of flint. They are called *meralkaijari* or deadly spears."

Mr. W. E. Stanbridge gives a brief account of the barbed spear as follows<sup>22</sup>:—"The light spear is about nine feet long and is either a reed having at the end a pointed piece of hard wood, about two feet long, secured to the reed by cement and a binding of sinews, or a thin sapling scraped to the required size with a shell, straightened and hardened by being passed through hot ashes, with a piece of the flower stem of the grass tree for the butt. In summer the spears are barbed for about eight inches, at the points, with small pieces of flint fixed in cement."

Sir T. L. Mitchell<sup>23</sup> mentions the discovery in a hut used as a casual habitation near Mount Arapiles, of a number of "jagged spears, some of them set with flints."

Similar chips are also put to quite a different purpose, for Capt. P. P. King described and figured<sup>24</sup> a peculiar knife or saw. "The knife or '*taap*' is perhaps the rudest instrument of the sort ever made; the handle is about twelve inches long, scraped to a point, and has at the distal end, three or four splinters of sharp-edged quartz stuck on in a row with gum, thus forming a sort of jagged instrument. . . . It is thus used: after they have put within their teeth a sufficient mouthful of seal's flesh, the remainder is held in their left hand, and, with the '*taap*' in the other, they saw through and separate the flesh. Every native carries one or more of these knives in his belt besides the hammer, which is also an indispensable instrument with them." In a footnote he further remarks that the natives of King George Sound "hold the knife underhanded, and cut upwards." A modification of this knife, or saw, occurs on the north-east coast of the continent, by the replacement of the stone chips with small shark's teeth.<sup>25</sup>

#### NO. VIII.—PLATE XLIII., GROUP 2.

Numerous adze-like instruments were obtained, these are generally clean cut, but some exhibit flaking and chipping to

<sup>22</sup> Stanbridge—Trans. Ethnol. Soc., (n.s.), i., 1861, p. 292.

<sup>23</sup> Mitchell—Three Expeditions into the Interior of East. Australia, ii., 1837, p. 193; Eyre—Jnls. of Expeditions of Discovery into Cent. Australia, i., 1845, p. 269.

<sup>24</sup> King—Survey of the Intertropical and Western Coasts of Australia, ii., 1827, p. 139-40 fig.

<sup>25</sup> Partington—Album, 3rd series, pl. 129, f. 1; Etheridge—Rec. Austr. Mus., iv., 5, 1902, p. 207, pl. xxxvi.

fashion the stone to the required shape and provide a broad cutting edge. Implements of this kind but on a larger scale, were usually mounted on the end of a stout stick about eighteen inches in length and sometimes bent, the stone being cemented in with gum; this was used as a gouge. The cutting edge in some cases is hardly visible and rarely projects more than an inch or less. Some adzes have a stone at each end of the shaft.

NO. IX. — PLATE XLIV., GROUP 4.

Gouges of various kinds were obtained in large quantities. These are quite peculiar in shape and closely resemble cores. They are frequently flaked or chipped all over, and the cutting edge is usually semi-circular and provided with a central notch, or a slightly projecting tooth. They are mostly thick and more or less subconical with the working edge at the apex of the cone.

NO. X. PLATE XLIV., GROUP 1.

Smooth scrapers were found in abundance especially on the various shell heaps. They are simply clean cut flakes from pebbles, with one flat side and the other convex, and consisting of the original surface of the pebble. The thin edge is mostly smooth but in some cases it is finely notched.

NO. XI. — PLATE XLII., GROUP 1, FIGS. 10 AND 11.

Two gritty sandstone rasps were obtained at Bondi. These are practically identical with similar tools from Cherokee, Iowa, U.S.A.<sup>26</sup>

NO. XII.—PLATE XLII., GROUP 1, FIG. 6 FROM LEFT.

A single nose style or ornament was found at Maroubra. The ornament is nearly three inches long and about one quarter of an inch in diameter, somewhat tapering towards the ends, and exhibiting two or three faint longitudinal ridges and many slight transverse depressions, which probably indicate the original chipping. The specimen however is much worn, probably through use, and the surface details are obscure. When discovered it was thought to be simply a piece of ordinary slate pencil, but on applying a knife it was found to consist of some material much harder than slate pencil.

---

<sup>26</sup> Wilson—Ann. Report Regents Smithsonian Inst. (U. S. Nat. Mus. Report) for 1897 (1899), pt. 1, p. 285, pl. xxvii.

## No. XIII. — PLATE XLIV., GROUP 3.

A large series of irregularly shaped objects was found. In many cases they are simply flakes, but some exhibit special flaking and chipping. These instruments were possibly intended to be used as knives.

## No XIV.

Numerous tomahawks, grindstones, knappers, anvils, and cores were secured, but these were for the most part of the usual kind and do not require any description.

The specimens figured on each plate have been reduced to about one third natural size. To facilitate reference they are classified in groups, and inasmuch as they are all arranged in rows, any particular specimen may be easily found by counting from left to right in any given group.



ON THE OLIGOCHÆTA FROM THE BLUE LAKE,  
MOUNT KOSCIUSKO.

By W. B. BENHAM, D.Sc., M.A., F.Z.S., CORR. M.R.S. Tasm.,  
Professor of Biology, University of Otago.

(Plates xlvi., xlvii.).

I have to thank the Trustees of the Australian Museum for giving me the opportunity of studying this small collection of Fresh-water Annelids, from the Blue Lake, Mt. Kosciusko, as they are, so far as I am aware, the first aquatic Oligochaetes from the Australian continent that have been identified.

The tube received by me in March, 1906, contained a considerable number of small worms referable to three species:—

*Family* TUBIFICIDÆ.

1. *Tubifex davidis*, sp. nov.
2. *Branchiura pleurotheca*, sp. nov.

*Family* PHREODRILIDÆ.

3. *Phreodriloides notabilis*, gen. et sp. nov.

These were collected by Mr. Charles Hedley, under the direction of Prof. T. W. E. David, in the Blue Lake, which is situated at a height of 6000 feet above the sea, near the top of Mt. Kosciusko. The depth from which they were obtained is thirty-five feet; the bottom is of soft mud, and the temperature was 44° Fahr.

The worms had, apparently, been treated with osuric acid, which, unhappily, is ill-suited for these animals; for not only does it render the body wall rather opaque, so that the internal organs can only be studied with difficulty in entire specimens, even when stained and mounted in canada balsam, but it also appears to render the chaetæ brittle, for, in the smaller specimens, they are broken off short at the level of the body wall. Hence the labour of identification is increased by the use of this reagent.

The worms, too, were soft and so readily torn in handling that it was not possible to make satisfactory dissections for the isolation of the genital ducts. Sections have been prepared, which with the study of entire individuals, both in glycerine, and after being stained, have enabled me to give the following account.

Of the three species, *Tubifex davidis* is readily distinguishable by its larger size, especially by its greater stoutness: the other two are more slender and scarcely distinguishable from one another except by aid of the microscope, though *Phreodriloides notabilis* is altogether a more delicate worm than *Branchinra pleurotheca*.

I have not attempted to make an exhaustive study of either species, but have limited myself to a description of such features as are important in characterising the species.

The types and microscopic preparations which were used in this study, are in the Australian Museum.

#### TUBIFEX DAVIDIS, *sp. nov.*

(Pl. xlvi., figs. 1-6).

The numerous individuals of this worm seem to indicate that it is the predominant species, so far as this collection allows me to judge. Unfortunately the majority are broken, and others so coiled as to make it impossible to give reliable measurements.

*Dimensions.*—I estimate that the worm measures from 25 to 40 mm. in length, with a diameter of 1 mm.

The skin is smooth, there are no papillæ, though the posterior segments are highly glandular.

The *Prostomium* is bluntly conical, and is equal to nearly twice the length of the first segment.

*Chætæ.*—The usual four bundles are present on each segment: the dorsal bundle consists of two kinds, "capilliform" and "forked crochets," but in the anterior dozen or so segments some of the latter have an extremely delicate membrane, or a single intermediate tooth, between the limbs of the fork ("ctenates") (Pl. xlvi., fig. 2).

The two kinds of chætæ alternate in a bundle, and in the greater part of the worm each bundle consists of three or four capilliforms and three or four crochets; but in the ante-clitellian segments, the number of capilliforms is increased to six or even seven—in these segments the additional capilliforms are dorsally placed (Pl. xlvi., fig. 1).

The capilliforms of the anterior segments are much longer than those at the hinder end, and there is a gradual diminution backwards.

One of these chaetae from segment vii. measures 5 mm., while one from near the hinder end measures only 1·87 mm. total length.

The crochets of the dorsal bundles have the two teeth of equal size and form, diverging somewhat from each other, but the "lower" tooth is not curved away for the "upper."

The number of chaetae in the dorsal bundles of the anterior segments is shown in the following table:—

Segment ...	ii.	iii.	iv.	v.	vi.	vii.	viii.	ix.	x.
Capilliforms	1	4	5	6	7	6	5	4	4
Crochets ...	2	3	4	4	4	3	4	3	4

The ventral chaetae are crochets throughout the body and usually are three or four per bundle. Those of the anterior segments are larger in all dimensions than those of the rest of the body.

The two teeth are nearly of equal length, but the distal (or upper) tooth is the more slender, the proximal (or lower) tooth being curved away from it in the usual typical manner (Pl. xlvii., fig. 3). In the anterior segments the two teeth are much more different in form, the proximal being stouter and the distal still more slender, so that it appears to be rather larger.

As is generally the case in the family Tubificidae, there are no chaetae, either dorsal or ventral, on segment xi. of the mature worm, though they are present in the immature individuals; in one individual, in which the genital organs were not yet fully developed, there is still one capilliform chaeta remaining in the dorsal bundle of this segment, indicating, of course, that the bristles drop out as the worm attains its full sexual development.

In segment x. of the immature worm, the ventral chaetae have the normal shape and arrangement; but these also drop out as maturity is approached, and each bundle becomes represented by a single "copulatory chaeta" of special form and surrounded by a spherical gland (Pl. xlvii., fig. 6).

The copulatory chaeta is a delicate, slightly curved rod, with a simple blunt point, not recurved. It measures 0·105 mm. and is much slenderer than a ventral chaeta, and shorter (Pl. xlvii., fig. 4). The copulatory chaeta, indeed, is so delicate, that

although I had seen it and sketched it in glycerine mounts,<sup>1</sup> I am totally unable to detect it in an individual stained and mounted in canada balsam, although the worm is mature. In sections the chaeta is seen to be solid and without a groove, such as exists in some species.

The *Clitellum* covers the segments x., xi., xii. The male pores and spermathecal pores occupy the usual position in segments xi. and x. respectively: the spermathecal pore is situated just posterior to the "copulatory chaeta."

#### INTERNAL ANATOMY:—

*Reproductive System.*—The testes and ovaries occupy the usual segments, and the sperm sacs occur in segments x. to xiii. The male-apparatus is constructed as follows:—The flat sperm funnel, lying in the tenth segment, against the anterior face of its posterior septum, leads into a delicate sperm duct, which after entering the eleventh segment, is somewhat coiled, or at least undulating, and passes upwards to enter the "atrium" near the dorsal surface of this segment. The atrium has the usual retort-shape of Tubificids generally, with its wider end upwards, into which there open the sperm duct and the moderate sized prostate (Pl. xlvii., fig. 5). The atrial duct then passes almost straight downwards to the ventral surface, piercing a small penis, which projects into a small penial sac or chamber, opening to the exterior by the male pore. There is no chitinous sheath to this penis, and the entire apparatus is confined to the segment xi.

The spermatheca, on either side of segment x., consists of an ovoid or cylindrical "ampulla" with very muscular wall, and a narrow duct about half the length of the ampulla (Pl. xlvii., fig. 6). The circular muscles of the ampulla are very strongly developed to form distinct rings. As above mentioned, the spermathecal pore is just behind the copulatory chaeta of each side.

I find no spermatophores, but that is not to say that these are not formed by this species. As a matter of fact, I could not detect any spermatozoa in any of the mature individuals studied, and unfortunately, the specimen sectionised turned out to be incompletely developed. The sexual organs are present, but not fully formed, and still more unfortunately I cannot find any other mature individual suitable for sectionising.

---

<sup>1</sup> The quantity of sand-grains in the intestine, and the soft condition of the body, rendered the investigation of the chaetae rather difficult. As compression caused the intestine to burst, and the sand-grains by their refringency interfered with the study of these structures.

*Vascular System.*—This presents a large heart in segment viii., and in the preceding segments, iv. to vii. paired, very undulating commissurals, which are also repeated in the subsequent segments throughout the body. At the hinder end, these become much longer, and therefore take a more undulating course along the inner surface of the body wall—but they give off no branches; there is no network.

I made no particular study of the *nephridia*, owing to the broken condition of the sections, due to the sand contained in the intestine. I note, however, that the nephridia commence behind the clitellum; here the pores are well defined, and evident in the body wall in an individual that had been bisected and flattened out, after removal of the gut. These pores are in line, as usual, with the ventral chætae, but no similar pores occur anteriorly to the clitellum.

*Remarks.*—This species belongs to that group of the genus *Tubifex*, which is characterised by the presence of special copulatory chætae near the aperture of the spermatheca, as in the familiar European species *T. (Psammoryetes) barbatus*, Grube. The genus *Tubifex*, as emended by Michaelsen (1900), includes a number of species which have been described under several generic names such as *Hemitubifex*, *Spirosperma*, *Heterochæta*, *Embolecephalus*, as well as *Psammoreyetes*.

Of the “*Psammoreyetes*” group only eight species have been recorded, viz.:—*T. velutinus*, Grube, *T. barbatus*, Gr., *T. heuscheri*, Bretscher, *T. camerani*, Visart, *T. illustris*, Ditlevsen, *T. fossor*, Dtl., *T. sarvenensis*, Pierantoni, and *T. hamatus*, Moore.

From each of these the present species differs in certain characters, such as the form and number of the chætae in the dorsal bundle, details as to the proportions of the teeth of the ventral chætae, form of the copulatory chætae, absence of penial sheath, etc., etc.

The species which it most closely resembles is *T. heuscheri* (with which *T. camerani* is possibly identical), but from this the form of the copulatory chæta seems to mark it off. In that species the free end is sharply curved and pointed, it is twice the length of the ordinary ventral chæta, and thicker than it: it is also said to be grooved on its exposed surface. It is possible that in my specimens of *T. davidis*, the copulatory chæta is not fully formed—see above as to the difficulty of studying it—and that when fully formed it would differ from the condition described above, but I do not suppose that this is the case, and I believe that we are justified in regarding it as distinct from the European forms.

For the convenience of comparison with Michaelsen's diagnoses of the first two of the above listed species, I give briefly the characters of the new species:—

*Turifer davidis*, sp. nov.

Integument smooth, dorsal chaeta capilliform and crochets, usually three or four of each kind per bundle. Some of the crochets anteriorly present an intermediate tooth, or a delicate membrane. Ventral chaetae, crochets three or four per bundle; the teeth equal, but the lower one stouter. A single copulatory chaeta on each side of segment x., slender, slightly curved, blunt pointed, and smaller than the ventrals. There is no chitinous penis; spermatheca short, cylindrical, with a duct of half its length.

BRANCHIURA PLEUROTHECA,<sup>2</sup> sp. nov.

(Pl. xlvii, figs. 7-12)

This is a much slenderer worm than the preceding, and stouter, but owing to the coiled state of the mature worms, the figures given here are only estimated, though approximately correct. The body wall is highly granular.

*Dimensions*.—About 12 to 15 mm. × 0.5 mm.

*Chaetae*.—The dorsal chaetae consist of crochets, and, in the anterior segments, capilliforms are added to the bundle. Owing to the brittle nature of the chaetae, the majority of them, in all the individuals, have the outer ends broken off, hence there is some difficulty in distinguishing the existence of capilliforms—but by a prolonged and careful study of entire preparations and sections, and preparations treated with glycerine and potassium-hydrate, and the use of high powers of the microscope, it is possible to recognise that in these anterior bundles, one or two of the dorsally placed bristles are rather more delicate than the rest, and their bases are rather longer and straight.

I was led to examine the matter very carefully for other anatomical characters—*e.g.* the modified chaetae near the male pore—have been hitherto found only in association with these chaetae.

<sup>2</sup> Πλευρον—side, θηκα—spermatheca: refers to lateral portion of the aperture of this organ.

Anteriorly there are three or four chætæ in each dorsal bundle, of which one or two are capilliforms. After the clitellum, only crochets are present, and usually two per bundle.

The ventral chætæ are crochets to the number of two or three in each bundle. They are slender and short, measuring 0·08 mm.; the upper (distal) tooth is nearly twice the length of the proximal, and is much slenderer (Pl. xlvi., fig. 7).

The arrangement of the chætæ is as follows:—

Segment ...	ii.	iii.	iv.	v.	vi.	vii.	viii.	ix.	x.	xi.	xii.
Crochets ...	2	2	2	2	2	2	2	2	2	2	2
Capilliforms	2	1	2	3	1	1	1	1	0	0	0

On the segment xi. the ventral chætæ are characteristically arranged in a bunch—the bases divergent, the tips all close together, projecting through a pore on a small papilla (Pl. xlvi., fig. 11)—this bunch of four to six chætæ, instead of being arranged transversely to the axis of the body, is sagittal,<sup>3</sup> and hence conspicuous in an entire specimen. The copulatory chætæ, are thus arranged in a reverse way from the normal ventrals, but in form, the individual copulatory chætæ are crochets, nearly twice the length of the ventrals, measuring 0·15 mm. The bases of these are surrounded by a group of muscles, but there is no special gland.

The *Clitellum* covers the segment  $\frac{1}{2}$  x., xi., xii. The male pore is on xi., just outside of and anterior to the copulatory chætæ. In section, a furrow is seen to run backwards from the pore to the level of the chætæ, possibly indicating that in copulation such a furrow is formed for the transference of the spermatozoa from the male pore to the spermatheca of another worm, and corresponds to the "spermatic groove" in Acanthodriline Earthworms.

The spermathecal pore is situated near the anterior margin of segment x., and occupies an unusual position, in that it lies near the lateral line of the body, about midway between the dorsal and ventral chætal rows (Pl. xlvi., fig. 10).

#### INTERNAL ANATOMY:—

*Reproductive System.*—The testes, ovaries, etc., occupy the usual segments. The sperm sac is median, and extends through segments xi. to xvi., while the four preceding segments, vii. to x.,

<sup>3</sup> I find the copulatory chætæ of *Tanpodrilus simplex*, Benham, to have this disposition, which is apparently shown in Stole's figure of *B. (Hyodrilus) coccinea*.

are filled with loose masses of developing spermatozoa. The sperm funnel is flat, leads into a short and delicate duct which passes directly downwards after piercing the septum to enter the eleventh segment; here it passes below the ovary, and I have been unable to trace it accurately amongst the ova—it winds somewhat and appears again near the apex of the atrium. Its course, indeed, is similar to that in *Taupodrilus simplex*, but it does not coil round the atrium as in that species.

The *Atrium* is a cylindrical organ, rounded at its upper end. It presents three more or less distinctly marked regions—the sac, the neck, and the atrial duct—each having a structure similar to that described by Beddard (1) in *B. sowerbyi*. That is, the sac itself is lined by tall glandular cells similar to those described and figured by me for *Taupodrilus simplex*; the short neck, which is not abruptly marked off, is lined by cubical cells (I was unable to detect cilia in my sections, though no doubt they exist as in other species), but the duct, which is sharply differentiated, is lined by columnar cells, which support a distinct cuticle, continuous with that of the outer epidermis (Pl. xlvii., fig. 8). The wall of the atrium is muscular, and outside this coat is a layer of “prostate cells” of a form essentially similar to those described and figured by Beddard (1)<sup>6</sup> and Stolc (14). In fact, except for minor details, the apparatus is characteristically Branchiuran. There is no penis other than the bunch of copulatory chaetae on their papilla.

The spermatheca, situated on each side of segment x., is relatively small, pyriform in shape, with a short distinct duct, bent at right angles to the ampulla (Pl. xlvii., fig. 9), to open laterally as above described. Though the ampulla is filled with spermatozoa, they are not moulded into a spermatophore.

*The Vascular System.*—Two pairs of enlarged “hearts” are visible in the entire specimens, lying in segments viii. and ix., while in transverse sections, a third is seen in segment x.

The usual narrow, undulating commissurals are present in the remaining segments. I was unable to detect a “supra intestinal vessel,” except possibly in segments x., xi., xii.—for in these segments, in transverse sections, two vessels lie above the gut, a larger, the “dorsal,” and a smaller one below it, which may be the “supra intestinal.” Further back, and further forwards, only a single vessel is visible above the gut; and throughout only a single one, the “ventral” vessel below. In the greater part of the body the commissural vessels instead of going directly from the dorsal to the ventral vessel, break up into a more or less elaborate plexus on the body wall (Pl. xlvii., fig. 12), and in the

<sup>6</sup> For references numbered in brackets see Bibliography at end of paper.



posterior third or so this network has very small meshes; the network is continuous from segment to segment. Such a network is rare in Tubificids—it has been described only in *Branchiura*, as emended by Michaelsen (9), as well as in *Rhizodrilus limosus*, Hatai (8), and to some extent in *R. pilosus*, Goodrich (7).

The form and constitution of the network is more like that figured by Hatai than of the other species referred to, viz.:—Each “latero-dorsal” and “latero-ventral” vessel (*pr.*), of which there is a pair in every segment, after reaching the body wall in these post-clitellian segments, breaks up into a number of anastomising branches, with a tendency to a longitudinal and transverse arrangement. It is quite unlike the simpler arrangement of *B. sowerbyi*, and is less elaborate than that in *B. coccinea* (14).

The first nephridium occurs behind the atriopore in segments xiii. and xiv.

*Remarks.*—That this worm is closely allied to Stolc’s “*Ilyodrilus coccineus*” there can be no doubt, and there appears to me a certain amount of truth in Ditlevsen’s criticism (6) of Michaelsen’s union of this worm with *Branchiura sowerbyi* in the genus *Branchiura*—but I am not in a position to discuss this question on the present occasion, and I have therefore followed Michaelsen in placing the species in the genus *Branchiura*. I would remark, however, that if the two species are distinct, a new generic name must be found for “*Ilyodrilus coccineus*,” since *Ilyodrilus* was used by Eisen earlier in a different sense.

In a recent article Michaelsen has severely criticised my genus *Tanpodrilus*, and denies that it is even specifically distinct from *B. coccinea*. To this criticism I hope to reply after reading his memoir on the Elbe Oligochaetes, which, unfortunately, I have not yet seen. Possibly, *B. pleurotheca* may be a variety of *B. coccinea*, but till I have studied this memoir I shall allow the above account to stand.

The present species may be diagnosed thus:—

*Branchiura pleurotheca*, sp. nov.

Chaetae, dorsal bundles of 2-3 crochets, with capilliforms added in anterior segments; ventrals crochets, with upper tooth longer than the lower. On segment xi., behind the male pore, a bunch of copulatory chaetae in the sagittal plane, the points converging, the chaetae similar in form, greater in size than the other ventrals. Clitellum  $\frac{1}{2}$  x., xi., xii.: spermathecal pore lateral, near anterior margin of x. Male efferent apparatus as in *B. coccinea*, but the atrium elongated ovoid, and the sperm duct opening at its apex. An elaborate integumental blood plexus in the greater part of the body.

PHREODRILOIDES, *gen. nov.*

Resembling *Phreodrilus*, Beddard, but without a spermatheca. The sperm duct opens into a muscular, but non-glandular sac, containing spermatozoa, which opens to the exterior in segment xii.

PHREODRILOIDES NOTABILIS, *sp. nov.*

(Plate xlvii.).

Only a single individual of this very interesting worm was received, but fortunately it was sexually mature. It was, after examination in glycerine, stained and mounted in canada balsam; later it was unmounted, and the anterior end cut into serial sections.

*Dimensions.* It is altogether shorter and more slender than the preceding; it was coiled in a flat spiral at each end, so that the length here given is only approximately correct, viz., 8 mm. The body wall is very glandular; the glands are in two distinct annular groups in each segment, that is, each segment is biannulate, of which the larger occupies the greater part of a segment, and a much narrower one lies near the posterior intersegmental furrow.

*Chaetae.*—The ventrals commence in segment ii., and the dorsals in iii. (as in *Phreodrilus*). The ventral bundle normally contains a single chaeta, which is a simple-pointed sigmoid, with very feebly expressed nodulus (Pl. xlvii., fig. 13). But in a few segments I noted two such chaetae. These ventrals measure 0.05 mm.

The dorsal chaetae are entirely capilliforms, and there appear to be two in each bundle, one longer and thicker, one shorter and finer. This is certainly the case in segments iii. and iv., but unfortunately the rest were broken, the anterior end being protected by its curvature retained them when mounted in glycerine. After manipulation, however, I found that even these had been broken. I failed to measure them, but the longer chaeta was rather greater than half the diameter of the body.

A careful study of transverse sections shows that each of the subsequent segments contain bases identical with that of these two segments, *i.e.*, the inner end is abruptly truncated, there is no nodulus, and the embedded portion is straight—all characters of capilliforms. Chaetae are absent in segment xii., and there are no copulatory chaetae.

The *Clitellum* commences at about the middle of segment xii. and surrounds segment xiii., but only a very short portion of the ventral surface is glandular.

The *male pore* is situated near the anterior margin of segment xii., rather medial of the line of the ventral chaetae. There is no spermathecal pore.

## INTERNAL ANATOMY:—

*Reproductive System.*—The structure of the male efferent apparatus is very peculiar. A pair of testes lies in segment xi., on the anterior septum; the sperm funnel is simple, and the sperm duct after piercing the septum xi./xii., passes backwards in a slightly undulating course on the mesial side of a large muscular sac, into the neck of which it opens (Pl. xlvii., fig. 15).

The muscular sac in segment xii. was very conspicuous in the entire specimen, as it is filled with ripe spermatozoa. It is nearly cylindrical, but curved, so that it is convex dorsally; its rounded free extremity is directed forwards and rests close behind the septum xi./xii., while posteriorly, after curving downwards as it approaches the middle of the segment, becomes rather narrower, to form a short "neck." This now opens into a small, sub-spherical chamber through its mesial wall. This chamber, which may be termed the "penial chamber," in its turn communicates with the exterior by a comparatively small pore on the ventral surface of segment xii. (Pl. xlvii., fig. 14).

The structure of these parts is as follows:—The "muscular sac" is lined by a flat epithelium, in which nuclei can only be distinguished here and there, surrounded by a thick coat of circular muscle-fibres (Pl. xlvii., fig. 16). There is no glandular covering, and no gland opening into this sac. The sperm duct has the usual structure, and opens into the narrow neck of the preceding near the opening of the latter into the "penial chamber" (Pl. xlvii., fig. 15). The short "common duct" thus formed does not differ in structure from the rest of the sac. At the point of entrance of the sperm duct, the cilia project into the sac (Pl. xlvii., fig. 16). The subspherical "penial chamber" appears to be an invagination of the epidermis, it is lined by an epithelium, which over the greater part of the outer hemisphere is similar to the epidermis, but the whole of the mesial surface of the wall, as well as the apex and part of the outer wall, is lined by a layer of tall glandular cells (Pl. xlvii., fig. 17). The wall is, further, provided with a thin coat of circular and longitudinal muscles, as well as "retractor muscles" connected with the body wall. The structure of this chamber suggests that it is capable of protrusion, and on one side of the body, the common duct (or neck of the muscular sac) is itself pushed forward into the cavity of the "penial chamber" (Pl. xlvii., fig. 17) in such a way as to suggest a "penis" such as exists in some species of *Phreodrilus* (*P. albus*, *P. lacustris*), but of much smaller dimensions.

In segments xi. and xii. are masses of developing spermatozoa; the former segment is filled by them, the latter only partly so,

and in segment xiii. is a median sperm sac, with a definite wall. The ovary is in segment xii. in the usual position, and loose ova of various sizes also occur in this segment: in xiii. and xiv. are also very large ova, one in each segment, lying in an ovisac. The oviduct I was unable to trace satisfactorily, but at the boundary of segments xii./xiii. I detected a mass of small nuclei in a position suggesting the duct, but the compression to which the worm had been subjected had entirely obliterated the lumen, if it be the duct, and though I was able to trace these cells into continuity with the epidermis, no pore was visible.

The *alimentary canal* presents no special features. The pharynx is present in segment ii.; the œsophagus, thick-walled and of small diameter, extends into the tenth segment, beyond which it opens abruptly into the thin-walled intestine, which has a diameter about twice that of the œsophagus: here, starting in segment xi., the gut is filled with sand grains, diatom shells, etc. There are salivary glands or septal glands on the anterior wall of segments v. and vi.

Of the *vascular system* the following facts were noted. The dorsal and ventral vessels are the only longitudinal trunks; these are connected by delicate commissurals in segments iii. to vii., the last being slightly larger than the rest, but not definitely "heart"-like. There are no integumental vessels; on the outer wall of the intestine, however, there is a very regular network of blood-vessels formed of closely and regularly set circular vessels connected by short longitudinal ones. This recalls Michaelsen's account of the arrangement in *Phreodrilus kerguelenensis* (10). The blood is quite pale in colour.

The nephridia are loose-coiled tubes of a Tubificid character; they seem to be asymmetrically disposed, for the first organ lies on the left side of segment vi. Those of the following segments are also confined to the left side; that in segment x. is on the right side; and further back I see only one in a segment.

*Remarks.*—Although the worm agrees with *Phreodrilus* in general external anatomy and in several of the internal characters, so as to be easily included in the family Phreodrilidae, as defined by Michaelsen (1902), yet it differs from all the species of the genus *Phreodrilus* in the structure of the male efferent apparatus, and in the apparent absence of a spermatheca. I say "apparent" absence, for it may possibly be that the muscular sac, filled with spermatozoa, has received those spermatozoa during copulation with another worm. But in no Oligochaete hitherto studied do we know of such a spermatheca connected in this way with the male duct. On the other hand, we not unfrequently find the ripe spermatozoa filling more or less of the atrial cavity, through

which of course they must pass on the way to the exterior. But in most of these cases there is no doubt as to the nature of the chamber; it is provided with a glandular lining, or receives the necks of the gland cells of the prostate, and though we are in ignorance as to the exact function of this secretion, yet it appears probable that it takes some share in the process of copulation. In the present worm, however, the sac which contains the spermatozoa is absolutely non-glandular—there is neither prostate, nor prostate cells outside it, nor glandular cells lining it. The wall is strongly muscular, far more muscular than is the atrium in other aquatic Oligochætes, and in this respect resembles the muscularity of the spermatheca in many Tubificids. At any rate, we have to note the entire absence of a spermatheca corresponding to that of *Phreodrilus*.

In all the species of this genus the spermatheca is a long sac extending through two or more segments and opening near the anterior margin of segment xiii. This is quite an exceptional position for this organ, in the class, for it is almost universally in front of the male pore, though in certain of the Lumbriculidæ it is behind the pore.

The idea occurs to one that in *Phreodriloides* the pore of the spermatheca has passed forwards into segment xii., and has become coincident with the male pore. But there is nothing analogous to such a fusion throughout the Oligochæta, and a more reasonable explanation is that the atrium has become a reservoir for the spermatozoa, and that copulation does not occur, that the muscular sac (or "autospermatheca") discharges its own spermatozoa on its own ova, during the formation of the cocoon.

But there is another feature in which this new genus differs from *Phreodrilus*—in that genus the sperm duct opens into a more or less tubular organ lined with glandular cells and termed the "atrium," which in turn opens through a "penial sac" lined by flatter cells, and surrounded by muscles. This sac is quite small or evanescent in *P. kerguelensis* (10), but is of considerable size in *P. lacustris* and others (see Benham, 4), and further, in most species the pore is at the end of a conical protrusible organ lying in this sac.

From a mere inspection of a figure, the male apparatus of *Phreodriloides* appears to be readily comparable with that of *P. kerguelensis*, Michaelsen, and *P. lacustris*, Benham, were it not that what is a highly glandular sac (atrium) in these two species, is a non-glandular, highly muscular sac in *Phreodriloides*; and it appears that the "penial chamber" of the latter—partly glandular as it is—may represent both the atrium and the penial sheath of such a form as *P. lacustris*. On the other hand, there

is some slight evidence that this penial chamber is eversible, when it would correspond only to the penial sheath of *P. lacustris*.

If this chamber is really eversible, we must probably conclude that copulation does take place, and if so, the only sac capable of receiving spermatozoa is the muscular sac, which would thus function as a spermatheca. So that whatever may be the true homologies of these parts, the distinctness and peculiarity of the new genus are sufficiently striking.

#### BIBLIOGRAPHY.

1. Beddard, 1892. A New Branchiate Oligochaete, *Quart. Jour. Micro. Sci.*, xxxiii., p. 525.
2. Beddard, 1894. Naiden, Tubificiden, und Terricolen, *Ergeb. Hamburg Magalh. Sammler.*, p. 9.
3. Benham, 1903. Some n. sp. of Aquatic Oligochaeta from New Zealand, *Proc. Zool. Soc.*, 1903, ii., p. 209.
4. Benham, 1904. On some n. sp. of the genus Phreodrilus, *Quart. Journ. Micro. Sci.*, xlviii., 271.
5. Bretscher, 1900. Mitth. ub. d. Oligochäten-fauna d. Schweiz, *Rev. Suisse. Zool.*, viii., p. 11.
6. Ditlevsen, 1901. Studien an Oligochäten, *Zeit. Wiss. Zool.*, lxxvii., p. 416.
7. Goodrich, 1901. On the structure of *Vermiculus pilosus*, *Quart. Journ. Micro. Sci.*, xxxvii., p. 253.
8. Hatai, 1899. On *Vermiculus limosus*, *Ann. Zool. Japon.*, iii., 103.
9. Michaelsen, 1900. Oligochaeta : Das Tierreich, p. 48, 49, 524.
10. Michaelsen, 1902. Die Oligochäten d. deutscher Tiefsee Exped., p. 130.
11. Moore, 1905. Some Marine Oligochaeta of New England, *Proc. Acad. Nat. Sci. Philadel.*, p. 359.
12. Pierantoni, 1902. Due n. g. di Oligochèti marini, *Bull. Soc. Natur. Napoli.*, xvi., p. 5.
13. Pierantoni, 1905. Oligocheti del Fiume Sarno, *Archivio Zool.*, ii., pp. 228 and 235.
14. Stolic, 1888. *Abh. Böhm. gesell.*, ser. 7. vol. ii., p. 38.
15. Visart, 1901. Tubifex camerani, *Boll. Mus. Zool. Torino.*, xvi., no. 387.

MINERALOGICAL NOTES: No. IV.—ORTHOCLASE IN  
NEW SOUTH WALES

By C. ANDERSON, M.A., B.Sc., Mineralogist.

(Plates xlvi.iii.-lii.).

Macroscopic crystals of felspar are of common occurrence in the granitic area of Northern New South Wales and have been noted by various observers, but so far no crystallographic description has appeared. It is proposed in this paper to describe and illustrate some of the more interesting orthoclase crystals comprised in the Australian Museum collection, plagioclase felspars being reserved for a subsequent article.

The specimens figured were with one exception acquired by the Trustees from Mr. D. A. Porter, of Tamworth, to whom also I am under obligation for particulars of their finding and mode of occurrence. Mr. E. C. Andrews, of the Geological Survey of New South Wales, who possesses an extensive knowledge of the granites of New England, has been good enough to examine the collection, and has given me valuable information regarding the field relations of the rocks in which the felspars are found.

For identification purposes Becke's method was employed; by the use of a liquid with a refractive index greater than those of orthoclase and about equal to the mean index of albite, orthoclase was easily distinguished from plagioclase. This method was supplemented by observation of the extinction angles on cleavage flakes. The crystal forms were determined by inspection corroborated by measurement with a contact goniometer.

COCKBURN CREEK.

(Plate xlvi.iii., fig. 1).

A single specimen from "Beadle's Conditional Purchase," Cockburn Creek, near Tamworth, is in the Museum collection. It consists of an aggregate of glassy crystals of a typical adularia habit, accompanied by small brownish crystals of axinite. The felspar presents the simple combination  $c$  (001),  $m$  (110),  $x$  ( $\bar{1}01$ ),  $c$  and  $x$  having a tendency to oscillate with one another and give a somewhat rounded termination.

For chemical analysis some fragments were broken off, and, after examination with a hand lens and removal of a slight iron stain by hot hydrochloric acid, ground to fine powder. For general analysis .3241 gram was taken, for alkalies .4962 gram. The alkalies were determined by Lawrence Smith's well-known method, the amount of alkali in the calcium carbonate employed being determined and allowed for. The filtrate from alumina gave no precipitate with ammonium oxalate on prolonged standing, hence lime, if present at all, must be in very small amount; other components possibly present in traces, as oxide of iron, magnesia, and water, were not specially searched for in view of the small quantity of material available. Further, the percentage of silica is slightly low and of alumina rather high, perhaps owing to the contamination of alumina by traces of silica not removed in the first operation.

The appended analysis I. shows that the mineral is a nearly pure potash felspar; II. is Tschermak's analysis of adularia from Pfitsch,<sup>1</sup> while III. is the theoretical percentages for  $KAlSi_3O_8$ .

	I.	II.	III.
Si O <sub>2</sub> ... ..	63.90 %	64.5 %	64.7 %
Al <sub>2</sub> O <sub>3</sub> ... ..	20.61	18.4	18.4
Ca O ... ..		.3	
Na <sub>2</sub> O ... ..	.37	1.3	
K <sub>2</sub> O ... ..	15.39	14.8	16.9
	100.27	99.3	100.0

## OBAN.

(Plate xlvi., figs. 2, 3, 4; Pl. xlix., figs. 1, 2; Pls. l.-lii.).

In our collection there is a fine suite of felspar crystals, some of large size, from this locality, a notable feature being the excellent development of Baveno twins. This occurrence has been noted by Porter when describing quartz from Oban,<sup>2</sup> and he

<sup>1</sup> Tschermak—Ber. Ak. Wien, l., (1), 1865, p. 577 (quoted Dana—Syst. Min., 6th edit., 1892, p. 319).

<sup>2</sup> Porter—Journ. Roy. Soc. N. S. Wales, xviii., 1884 (1885), p. 75.



has recently given me additional information regarding the locality. The best specimens in the collection were obtained some thirty-five years ago by the late Mr. Thomas Clarke of Oban while blasting up a side channel in the granite in order to divert the stream from the bed of Oban Creek and facilitate the search for gold and tin-ore therein. Detached crystals of felspar, accompanied by tourmaline, topaz, cassiterite and gold are sometimes found in the alluvial wash in the neighbourhood of Oban.

The granite of Oban belongs to the "later and more acid type" of Andrews<sup>3</sup>; associated with it is a series of euries, often pegmatitic, and it is mainly, if not entirely, from the pegmatite phases that the large crystals of orthoclase here described have come. A common characteristic in hand specimens is a graphic intergrowth of quartz and felspar; this is seen on a large scale in the specimen shown in Pl. I., fig. 1, where the several quartz crystals project from the felspar with their vertical axes parallel. One interesting specimen consists of a group of large crystals of smoky quartz, the core of one being an elongated crystal of felspar twinned on the Baveno law but without terminations. A somewhat similar association is seen in Pl. li., where a well-developed Baveno twin is partly embedded in a smoky quartz crystal. Besides quartz (usually smoky), which is a constant companion of the orthoclase, we find associated with it, tourmaline, in the usual striated columnar crystals, and a plagioclase felspar, which, from refractive index and extinction angles, is found to be near albite. Plate lii., is a photograph of a slab consisting of large, buff, orthoclase crystals, much decomposed, seated on which are fresher, whitish crystals of albite in intercrossing pericline twins. A fine example of a Baveno doublet is shown in Pl. xlviii., fig. 2; it has the usual habit elongated parallel to the axis [*c*, *b*]. The two portions are not quite symmetrical to the combination plane, the face *c'* (001) slightly overlapping the face *b* (010), with which it is practically coplanar, but the boundaries of the two segments are easily traceable by the aid of the series of more or less parallel markings present on every face and having a direction on each approximately parallel to the intersection of the particular face with the plane of the pinacoid (100). These lines of corrosion are somewhat less pronounced on the prism *m* (110), which still retains a dimly vitreous lustre. This crystal measures about 4 × 2 cm.

A more complicated twin is represented in Pl. xlviii., fig. 3. It may be interpreted either as a triplet according to the Baveno

---

<sup>3</sup> Andrews—Rec. Geol. Survey N. S. Wales, viii., 2, 1905, p. 116.

law, or the segment on the left of the figure with faces labelled  $\bar{b}$ ,  $\bar{c}$ ,  $\bar{o}$ ,  $\bar{x}$ , may be regarded as twinned to the segment in the normal position on the Manebach law; it is not possible without very exact measurement to decide between these alternatives. This specimen, like the last, is much corroded in approximately parallel lines and it shows here and there small scales of a yellowish micaceous mineral. It measures about  $9 \times 3.5$  cm.

Another isolated Baveno doublet (Pl. xlix., fig. 1) exhibits an irregular junction of the two segments, that on the left partially enveloping the other. This crystal, which is drawn with the edge  $[\bar{b}, \bar{c}]$  perpendicular to the plane of the paper, measures  $3.5 \times 1.25$  cm.

An interesting crystal of which the exact locality is not known is similarly drawn in Pl. xlix., fig. 2. It was acquired in a collection of Australian and New Caledonian minerals from Mr. A. H. F. Stephens, who gave the locality as New South Wales. It bears a close resemblance to the Oban twins, and, like them, is accompanied by yellowish mica scales; hence we may fairly assume that it was derived from the granite of Oban or the neighbourhood. Like the specimen described above (Pl. xlviii., fig. 3), it may be regarded either as a Baveno triplet or as a combined Baveno and Manebach group. The junctions are remarkably regular and the crystal as a whole is well balanced; it is, though not the largest, perhaps the finest example of a Baveno twin in the collection of New South Wales orthoclase. It measures  $4.5 \times 1$  cm.

While the Baveno twins are the finest, crystals also twinned according to the other well established laws, the Carlsbad and Manebach, are forthcoming from Oban. Of the former the crystal represented in Pl. xlviii., fig. 4, may be taken as typical. It shows the forms  $c(001)$ ,  $b(010)$ ,  $a(100)$ ,  $m(110)$ ,  $z(130)$ ,  $x(\bar{1}01)$ ,  $y(\bar{2}01)$ ,  $o(\bar{1}11)$ ; of these the pinacoid  $a$  is of infrequent occurrence on orthoclase. The  $m$  faces are comparatively bright (it seems as if these resist corrosion with greater success than do the other faces). The terminal faces are marked by irregular branching lines with a general direction parallel to the edge  $[c, a]$ ; these markings are of very usual occurrence on orthoclase crystals, and, as they are accentuated on worn crystals, are probably due to corrosion. The  $b$  pinacoid is finely striated parallel to the intersecting edges of the prismatic zone. The faces  $c$  and  $x$  are represented in the figure as coplanar; strictly speaking  $c$  ( $\rho = 26^\circ 3'$ ) is somewhat steeper than  $x$  ( $\rho = 24^\circ 13'$ );

in Pl. xlix., fig. 4, the difference is slightly exaggerated to show that the faces are not quite in one plane. Well-defined cracks parallel to the basal pinacoid traverse the faces in the prism zone; by observing the direction of these cleavage cracks one can easily distinguish  $c$  from  $a$ , even when these are to all appearance coplanar and physically similar, and the dome  $y$  is not present. This crystal, which measures approximately  $2 \times 1.5 \times 1$  cm., forms one of a small group of felspar and smoky quartz crystals with a crumbly pegmatitic matrix. Seated in parallel position on, and partially embedded in, the figured crystal are small crystals of albite.

Manebach twins are not met with so frequently as Baveno and Carlsbad types. One good but rather decomposed example, accompanied by orthoclase in Baveno and Carlsbad twins, albite and smoky quartz was observed; in habit and development it is essentially similar to the crystal figured in Pl. xlviii., fig. 5, which comes however from Bolivia. In the Oban crystal albite is in parallel position with the two segments of the Manebach twin; hence the albite also must be twinned on the Manebach law.

On the whole the orthoclase crystals of Oban suggest a comparison with those described from Four-la-Brouque, France.<sup>4</sup>

#### URALLA.

(Plate xlix., fig. 5).

In the Museum collection are a few specimens of orthoclase from the Rocky River, Uralla, which are in general very similar to the Oban mineral. This similarity is no doubt due to their having been derived from a geologically equivalent pegmatite. All the Rocky River felspars, Mr. Porter informs me, were obtained in the alluvial gold wash, where they are accompanied by ilmenite, zircon, quartz and jasper. It is worthy of note that no tourmaline or cassiterite is found in the Rocky River wash, in which it differs from the alluvial drifts in the neighbourhood of Oban.

A Carlsbad twin from the Rocky River is interesting as an example of what is sometimes described as a left-handed twin, as distinguished from the other figured crystals (Pl. xlviii., figs. 4, 6 and Pl. xlix., fig. 4) which are right-handed. This is a comparatively small crystal, measuring about  $1 \times .8 \times .5$

<sup>4</sup> Gonnard—Bull. Soc. Fr. Min. vi., 1883, p. 265; *Ibid.*, viii., 1885, p. 307; *Ibid.*, xi. 1888, p. 177.

cm. It is associated in the hand specimen with crystals of smoky and ordinary quartz, albite in Carlsbad twins, and small scales of black mica, the last where the idiomorphic feldspar and quartz become merged into a fine-grained granite. The basal plane is fairly bright, while *x* is corroded and quite devoid of lustre, the distinction between the two being obvious at a glance.

Another specimen from this locality is in all respects similar to the (much larger) group from Oban figured in Pl. lii. The similarity is so pronounced that one would almost be inclined to regard them as fragments from one and the same block.

#### BOLIVIA.

(Plate xlvi., fig. 5 ; Pl. xlix., figs. 3, 4).

Just as the prevalence of Baveno twins marks the Oban orthoclase, so the special feature of the Bolivia occurrence, so far as represented in the collection, is the excellence of the Carlsbad twins. The crystals are in general fresher than those from Oban and Uralla, this being perhaps due to their being obtained from druses in the "acid" granite, not from pegmatite veins and lenses.

In Pl. xlix., fig. 3 is shown a group consisting of three Carlsbad twins and a Manebach twin, accompanied by three crystals of slightly smoky quartz ; the same Manebach twin is partially idealised in Pl. xlvi., fig. 5. Another fine crystal twinned on the Carlsbad law (Pl. xlix., fig. 4) is one of a group of four, and measures about  $3 \times 2 \times 1$  cm. The prism faces are smooth and bright, the terminal faces and the *b* pinacoid slightly striated parallel to their intersection with the plane of the *a* pinacoid.

#### INVERELL.

(Plate xlvi., fig. 6).

From a decomposed feldspar-porphry about fourteen to twenty miles north-east from Inverell good examples of Carlsbad twins are obtained, one of which is drawn and partly idealised. The crystals are quite different in appearance from those described above from other localities in the State, as, instead of being white or buff in colour, they are brick-red. The figured crystal measures about  $2 \times 2 \times 1$  cm.

That I am able to present a plate of shaded drawings is largely owing to the instructions and hints of my colleague, Mr. A. R. McCulloch, to whom my best thanks are due.

## THE RESULTS OF DEEP-SEA INVESTIGATION IN THE TASMAN SEA.

### I.—THE EXPEDITION OF H.M.C.S. "MINER."

#### I. INTRODUCTORY NOTE ON THE FIRST DEEP-SEA CRUISE.

By W. A. HASWELL, M.A., F.R.S., Professor of Biology in the University of Sydney, and C. HEDLEY, F.L.S., Conchologist, Australian Museum.

Having been enabled by means of a grant from the Royal Society of London to procure 3000 fathoms of steel-wire rope (supplied at cost price by Messrs. Bullivant), and having been granted, through the courtesy of Brigadier-General Gordon, C.B., the use of H.M.C.S. "Miner" with a strong crew under the command of Lieut.-Colonel J. H. A. Lee, we made on 5th to 7th June a first essay in deep-sea investigation in the Tasman Sea. The only soundings on the chart outside the hundred fathom limit are those recorded by the "Challenger" in 1874; and, depending upon these, we made our first cast of the dredge when we had reached a position distant about fifty-five miles due east of Port Jackson Heads, expecting to reach bottom at a depth of about 2000 fathoms. This was unsuccessful, and, owing to the coming on of heavy weather, we were obliged to run in nearer to the coast. Early on the morning of the 7th June the bucket-dredge was let go in 80 fathoms, twenty-two miles east of Narrabeen, and returned with a satisfactory load. Leaving this station the vessel was steered about six miles east by south, and the trawl was lowered in a depth of 200-300 fathoms. It brought up some specimens of a Sea-urchin *Porocidaris elegans*, A. Ag., obtained by the "Challenger" at Station 164a, 410 fathoms, and Station 214, 500 fathoms, half-a-dozen specimens of a large Spatangid, as yet undetermined, and an undetermined Pennatulid. As the weather still continued extremely rough we were obliged to desist and return to port.

During the dredging operations use was made of the surface net, and at the farthest east limit a rich surface fauna was met with, comprising Radiolaria, Foraminifera, a Vorticellid, Dino-

flagellata, Chaetognatha, a Polyclad, Polychaeta, Crustacea, Heteropoda, Pteropoda and Urochorda. Nearer the coast the Radiolaria, particularly the colonial forms, were less abundant.

The mass of deposit brought up by the bucket-dredge consisted almost entirely of calcareous organic structures. The great bulk of this was composed of calcareous Polyzoa, mostly in small fragments, with numerous Foraminifera, many shells, and a considerable number of small solitary corals. The representatives of the last-named group which have been examined by Mr. J. S. Dennant, M.A., F.R.G.S., comprise *Platyotrochus compressus*, Ten. Woods, *Deltocyathus rotiformis*, Ten. Woods, *Dumocyathus parasiticus*, Ten. Woods, *Leptopannus discus*, Moseley?, *Notophyllia recta*, Dennant, *Holcotrochus crenulatus*, Dennant, *Flabellum australe*, Moseley, *Trematotrochus verconis*, Dennant?, and two new species, one of *Trematotrochus* and the other of *Flabellum*. A few small sponges, not yet determined, were attached to the tangles. The Polyzoa are being examined by Mr. C. M. Maplestone.

# THE RESULTS OF DEEP-SEA INVESTIGATION IN THE TASMAN SEA.

## I.—THE EXPEDITION OF H.M.C.S. "MINER."

### 2. THE COLONIAL RADIOLARIA OF THE TASMAN SEA,

By PROF. W. A. HASWELL, M.A., D.Sc., F.R.S.

(Plate liii.).

The colonial Radiolaria collected during the two-days cruise of H.M.C.S. "Miner" in June, 1906, were mostly obtained at a distance of over fifty miles off the coast. Here, probably on account of the strong southward-flowing current, with a surface temperature of  $65^{\circ}$  C, surface life was very abundant and varied. Owing to the unfavourable weather it was impossible to do more than drag the tow-net for a time within a few feet of the surface, and the specimens obtained had to be somewhat summarily disposed of. The fixing solution employed—a copper sulphate and corrosive sublimate combination—though very efficient as regards most of the surface organisms, was not entirely successful in the case of the colonial Radiolaria, having had, apparently, a softening effect on the jelly which led to the disintegration of most of the colonies. Fragmentary though the specimens are, the individual zooids prove to be remarkably well preserved. To complete the observations here recorded, however, the study of further material preserved in other ways, and of living specimens will be necessary, and what follows can only be regarded as a preliminary account of the colonial Radiolaria of this region.

The points of more general interest, to which attention is directed, are: (1) The observation in a species of *Collozoum*, as well as in *Belonozoum atlanticum* and *Rhaphidozoum pandora* of bodies which appear to be zooids that have undergone conversion into masses of microspores; (2) The observation in *Collozoum arcuatum*, n. sp., of a special phase in the life-history of the *Xanthelle*.

It is somewhat remarkable that so few Radiolaria have been recorded from the Tasman Sea. Of the colonial forms I find record of only three species having been found in that region, viz., *Sphaerozoum octoceras*, Haeckel, *S. australe*, Haeckel, and *Collosphaera fragilis*, Haeckel. The reason for this is, doubtless, that so little plankton-net collecting has been done in the open sea. The Radiolaria, and more particularly the colonial forms, do

not seem to abound near the coast, and, as far as Port Jackson and Broken Bay are concerned (and I have little doubt the same holds good of the other inlets), a simple Radiolarian of any kind is a *rara avis* in the surface net, and the colonial forms, so far as my experience goes, never occur.

None of the three species mentioned above occur in the present collection. On the other hand it comprises about seven species previously known from other parts of the ocean.

#### *Genus* COLLOZOOM.

The absence of skeletal parts in the genus *Collozoum*<sup>1</sup> renders the identification of the species in that genus a matter of considerable difficulty—particularly when one has to deal with preserved material, in which the form of the colony may not be recognisable. This difficulty is increased by certain discrepancies between the determinations of Haeckel on the one hand and of Brandt on the other. Thus with regard to the characters of the original species, *C. inermis*, supposed by the former to be cosmopolitan, and to be subject to considerable variation, there is a wide divergence in the statements of the two authors. According to Haeckel's description in the "Monographie,"<sup>2</sup> in this species the zooids are usually spherical, but may be compressed spheroids, or lens-shaped, or, rarely, elliptical, and there is a thick, often double, capsular membrane; in the "Report"<sup>3</sup> the specific name is restricted to forms with spherical zooids and a thin, simple-edged membrane. According to Brandt<sup>4</sup>, on the other hand, in the species in question the zooids are discoid or irregular, and a membrane is entirely absent.

Of the specimens of *Collozoum* obtained during the "Miner" excursion a considerable proportion belong to what may be termed the *C. inermis* group of Haeckel's sub-genus *Collolinium*—forms in which the prevailing shape of the zooid is spherical, and in which there is a single, relatively large, oil-globule. All the leading modifications and phases are represented—except that there are none in which a capsular membrane can positively be said to be absent.

Until further material has been obtained I think it better to defer any attempt to deal systematically with this group. But

<sup>1</sup> With the exceptions to be referred to later.

<sup>2</sup> Haeckel, E.—Die Radiolarien. Eine Monographie, 1862., p. 522.

<sup>3</sup> Haeckel, E.—The Radiolaria. Chall. Rep., Zool., xviii., 1887, p. 25.

<sup>4</sup> Brandt, K.—Die Koloniebildende Radiolarien: Sphaerozoen, (Fauna u. Flora Golfes v. Neapel, xiii., 1888., p. 6.)



there are three members of it which present certain features of special interest. These I will distinguish as *C. armatum*, n. sp., *C. alpha* and *C. beta* respectively.

*COLLOZOOM ARMATUM*, sp. nov.

(Plate liii., fig. 1).

The entire absence of skeletal parts is given by Haeckel (Rep. p. 24) as one of the diagnostic characters of the genus *Collozoum*. Brandt<sup>5</sup>, however, states that in *C. hertwigi* there may be present completely isolated needle-like spicules. Spicules identical with those of various *Sphaerozoum*-species are present in several of my specimens of *Collozoum*, but, from their mode of occurrence, these are undoubtedly to be looked upon as of the nature of foreign bodies. In the form now to be described, however, there is a true skeleton of an elementary character, although in other respects there is no departure from the character of the genus *Collozoum*.

The form of the colony is unknown, the species being represented only by two fragments, which, however, show quite distinct phases. The zooids in both are spherical, 0.1 mm. in diameter, with a distinct capsular membrane. One of them is in a fairly early stage of anisosporous reproduction, each capsule enclosing a large number of nuclei arranged in the characteristic way in rounded groups. The other is in the isosporous phase. In the latter the oil-globule is present; in the former it is not distinguishable. In neither are pseudopodia or pseudopodial matrix recognisable. The skeletal elements are extremely slender, simple fibre-like spicules in the inter-capsular jelly; they are about 0.2 mm. in length or a little longer, with a diameter of not more than 0.001 mm. The small size of the fragments precluded any attempts to determine the composition of the spicules.

*COLLOZOOM (ALPHA)*.

(Plate liii., fig. 2).

There is only one specimen of this form, a complete colony of spherical shape, only about 2 mm. in diameter. The zooids are apparently in the vegetative phase. They are spherical in form; only in one case is there a constriction indicating an early stage in vegetative multiplication. In each capsule there are 20-30

<sup>5</sup> Brandt, K.—Die Kolonebildende Radiolarien: Sphaerozoen, (Fauna u. Flora Golfes v. Neapel, xiii., 1888, p. 228). \*

nuclei, separated from one another by intervals filled with granular protoplasm; these are not arranged in a single layer. The nuclei appear as completely homogeneous masses of chromatin of somewhat irregular shape; in several cases phases of direct division are observable. Around the whole of the nuclei of each capsule is a thick layer of granular protoplasm. The outer boundary of each zooid is quite sharply defined, but, if a capsular membrane is present, it is not distinguishable, and must be extremely delicate. Pseudopodial matrix and pseudopodia are not to be made out. There is a single spherical oil-globule in each zooid. About 12-15 *Xanthellæ* are closely applied to each zooid, and there are also many in the intermediate spaces. The zooids are about .07 mm. in diameter; the nuclei about .01.

So far there is nothing to distinguish this form from an early vegetative phase of one of the *C. inermis* group. But, scattered over the surface of the colony, are some fifty bodies which differ entirely from the ordinary zooids. These are rounded masses of granular matter most of which are of about the size of the zooids, while a few are slightly larger, and some are considerably smaller. These are all superficial in position, superficial to all the zooids and to all the *Xanthellæ*, most of them projecting on the surface, and some being covered externally only by a very thin layer of the gelatinous matrix.

In this, as well as in the other colonial forms to be subsequently referred to in which they occur, these bodies are rendered conspicuous in my preparations owing to their not being affected by the staining agent used (paracarmine), and, in the cleared specimens, appearing very bright and yellowish in colour. When one of them was removed, and, after being returned to alcohol, acted on with hæmatoxylin, a distinct staining effect was produced, certain granules in the mass becoming more strongly effected than the rest. Owing, probably, to the condition of the material, the component parts of these granular masses could not be definitely isolated. But I have little doubt from their mode of occurrence that we have here to do with masses of microspores of small size. In Brandt's classical monograph microspores and megaspores are stated to be developed in the same zooid in *Collozoum* and in *Sphaerouzoum*, and the allied genera, but, if the above view should be fully confirmed, this, if it is a rule, is subject to some exceptions. This, however, is a question which can only be definitely settled with the aid of living material.

COLLOZOUM (BETA).

(Plate liii., fig. 5).

Another form of this *C. inermis* group is worth referring to

owing to a peculiarity of which at present I have no explanation. In this form, of which there are several specimens, all, unfortunately, fragmentary, the zooids have the usual spherical form, with a diameter of about  $\cdot 08$  mm. They are in the anisoporous phase with numerous small nuclei ( $\cdot 008$  mm. in diameter) arranged in rounded groups in the typical manner; and there is a large central oil-globule. There is a thin pseudopodial matrix giving off delicate pseudopodia which form a network. A few Algae adhere to each zooid and many lie in the interspaces.

There is a thin capsular-membrane; but this is almost hidden by a layer of minute bright bodies of about  $\cdot 0016$  mm. in diameter, which adhere to its outer surface. Whatever may prove to be the nature of these bodies, there can be little doubt from the constancy of their presence in this form and in this alone, that they represent a definite structure or structures, and are not of the nature of an artifact.

COLLOZOOM OVALE, *sp. nov.*

(Plate liii., fig. 3).

The prevailing form of the zooids is elliptical; a few are constricted as if about to divide. Both of the specimens are in the vegetative phase, with few (4-10) nuclei in each capsule. The membrane is delicate, the protoplasm very granular. In place of an oil-globule there is an irregular space towards the centre giving off branching lobes from which finer channels pass out in a radiating manner through the protoplasm to the periphery. There are no pseudopodia or pseudopodial matrix. A very variable, though never very large, number of Algae are closely applied to each membrane; others occur abundantly in the interspaces.

The length of the longest capsule is  $0\cdot 125$  mm.; its breadth  $0\cdot 05$ . The average length is  $0\cdot 1$ , and the average breadth  $0\cdot 05$ . The diameter of the nuclei is a little less than  $0\cdot 01$ .

The nearest allies of this form seem to be *C. ovatum*, Haeckel,<sup>6</sup> and *C. ellipsoides*, Haeckel.<sup>7</sup> The former has a single central oil-globule, and the diameter of its zooids is two to three times as great as in *C. ovale*. The latter has a number of oil-globules, and the length of the zooids is even greater than in *C. ovatum*.

---

<sup>6</sup> Haeckel, E.—The Radiolaria, Chall. Rep., Zool., xviii., 1887, p. 25.

<sup>7</sup> Haeckel, E.—*Loc. cit.*, p. 20.

What may be a different phase of the same species differs from the above in having the capsular membrane much less distinct in the presence of numerous pigment granules in the intracapsular plasm. There is a similar lobed space representing the oil-globule, but it does not give off the narrow radiating channels, and it may be simple and rounded. The Algæ are not in any way specially related to the zooids.

COLLOZOUM ARCUATUM, *sp. nov.*

(Plate liii., figs. 4a-4c).

In this species, in which the form of the entire colony is unknown, the zooids are elongate and sausage-shaped. Each contains about twenty nuclei which are axially situated in a mass of vacuolated protoplasm with pigment. Within the capsule are a number of pigmented bodies of irregular shape and varying size. There are one or two oil-globules.

There are no *Xanthellæ* of the ordinary character, their place being taken by a number of problematical bodies (figs. 4a, 4b, and 4c), many of which are in close apposition with the capsules of the zooids, while others lie in the intermediate spaces. The foundation of each of these is a spherical cell with a central nucleus, a few large rounded granules in the cytoplasm and vacuoles. Arranged around the surface of the cell, which appears to have a distinct cell-wall, are a varying number (usually six to twenty) of bright-looking bodies of somewhat variable shape, usually concavo-convex, often with one or two grooves or notches.

The resemblance which undoubtedly exists between the bodies above described and the "extra-capsular bodies" described in detail by Brandt is a purely superficial one. The latter are derived from the zooids, and appear to represent a phase in a special process of anisosporous division. The bodies now under consideration, on the other hand, represent a phase in the life-history not of the Radiolarian, but of the *Xanthellæ*. These bodies in fact correspond (as far as can be determined in the fixed specimen) in every respect with ordinary *Xanthellæ* with the addition of the small bright objects symmetrically arranged around each.

In a few cases (Pl. liii., fig. 4b) the bright bodies are represented by an almost unbroken layer of the bright substance.

BELONOZOOM ATLANTICUM, *Haeckel*.

*Belonozoom atlanticum*, Haeckel, The Radiolaria, Chall. Rep., Zool. xviii., 1887, p. 40.

To this species I refer several specimens which resemble one another and agree with Haeckel's description and figure in the character of the spicules. The entire colonies are more or less elongated and cylindrical. At least two distinct forms or phases are represented. In one the zooids are comparatively large (from 0.1 to 0.2 mm.), and each contains from one to three nuclei: there are many *Xanthella* in the layer (pseudopodial matrix) immediately surrounding the capsule. In the other form the largest of the zooids is about 0.1 mm. There are about half-a-dozen small nuclei in each, and there are very few Algae.

All the specimens contained the sharply-defined granular masses described as occurring in *Collozium alpha*. These vary a good deal in size, but are, for the most part, considerably smaller than the zooids. In a complete colony there are about a dozen of them, all placed superficially.

The "Challenger" locality for *B. atlanticum* is the tropical Atlantic.

BELONOZOOM HILLI, *sp. nov.*

This species forms spherical colonies. The spicules are all simple and unbranched, but are of two kinds. Those of one kind are extremely slender, elongated and curved, usually as long as, or somewhat longer than, the diameter of the capsules (0.15 mm.), and quite devoid of spines. The other set, which are much fewer, are shorter, usually straight, and beset with spines throughout their length—the spines being longest towards the ends. Between these two kinds are a number of intermediate forms—long, slender, usually curved, and spinose only, or chiefly, at the ends.

The capsules are large, about 0.15—0.24 mm. The outer portion of the intra-capsular protoplasm is granular and pigmented. In the interior are several—3-6—oil-globules of considerable size, and a number of nuclei, most of which are grouped towards the centre. Embedded in the pseudopodial matrix, which has a reticulate structure, are a number of Algae.

Brandt states that young specimens of *Spharozoom* may have needle-like spicules only. But, as he states that all the young stages of the species of that genus which he had closely studied were more or less elongated—cylindrical or sausage-shaped, I think it is most probable that the species above described is to be looked upon as a *Belonozoom*.

RHAPHIDOZOOM PANDORA, *Haeckel*.

*Rhaphidozoum pandora*, Haeckel, The Radiolaria, Chall. Rep., Zool., xviii., 1889, p. 49, pl. iv., fig. 6.

Several specimens were obtained of a *Rhaphidozoum* which agrees closely with Haeckel's definition and figures of *R. pandora*, the only difference being that the acicular spicules are somewhat stouter. The intra-capsular plasm is coarsely granular, and usually contains a small number (1-6) of large nuclei, though in a few cases there are a larger number. In zooids with a single nucleus there is a rounded oil-globule: in those with several nuclei this has become irregular, sometimes branched. The few *Xanthellae* that are present are all closely applied to the capsular membrane. Masses of granules (microspores?) of the same character as those observed in *Collozoum alpha*, all smaller than the zooids, occur superficially here and there, some actually projecting on the surface.

One specimen differs from the others in having the spicules more strongly spinose, the connecting shafts of the geminate spicules sometimes being beset with spines, and the spines of a few of the spicules having short branches.

The "Challenger" locality is South Atlantic near Ascension Island.

RHAPHIDOZOOM BRANDTII, *sp. nov.*

The spicules consist of (1) exceedingly fine, smooth, needle-like spicules (2) 4-5 rayed spicules. The former are mostly aggregated in such a way as to form a layer investing each capsule. Of the latter there are two distinct varieties, smaller, which are smooth, and larger, which are spinose towards the ends of the branches. The capsules are large (about 0.15 mm). The needle-like spicules are from .15 to .3 mm. The largest of the rayed spicules are of comparatively gigantic dimensions, each ray being nearly 0.2 mm. in length.

From *R. aciferum*, Haeckel, this species differs in having the needle-like spicules smooth and straight. From *R. arachnoides*, to which it is also allied, it differs in having the radiate spicules spinose and the needle-like spicules straight, not curved.

SPHÆROZOOM QUADRIGEMINUM, *Haeckel*.

*Sphaerouzoum quadrigeminum*, Haeckel, The Radiolaria, Chall. Rep., Zool., xviii., 1887, p. 44.

The specimen referred to this species agrees in all particulars with Haeckel's description except in the dimensions of the largest spicules, which is given as 0.15 mm., nearly twice as large as any in my specimen. The zooids have a diameter averaging 0.07 mm. The intra-capsular plasm is coarsely granular: it contains four to eight nuclei. Five or six *Xanthellae* are closely applied to each capsular membrane, and there are none in the intermediate spaces.

The "Challenger" locality for *S. quadrigeminum* is the North Atlantic and the Azores.

A single fragment was obtained of a *Sphærozoum* which closely resembles the above in the form and dimensions of the spicules; but which has the zooids thrice as large.

#### SPHÆROZOOM ALVEOLATUM, *Haeckel*.

*Sphærozoum alveolatum*, Haeckel, The Radiolaria, Chall. Rep., Zool., xviii., 1887, p. 43, pl. iv., figs. 2, 3.

It is with some doubt that I refer to this species several specimens of a *Sphærozoum*. The alveoli, to the presence of which the species owes its name, are certainly absent; but there is a close correspondence in the form of the spicules, though their size is less in my specimens than the measurements given by Haeckel. The zooids in two of the specimens have a diameter of about 0.06 mm.; they contain granular plasm with a central oil-globule and about half-a-dozen nuclei. In certain respects these two specimens, though in the same phase, differ from one another. In the one the spicules are very numerous, and are definitely arranged around the zooids; in the other they are comparatively few, and are irregularly distributed. The former specimen has no *Xanthellae* in the interspaces between the zooids; while in the latter they are numerous.

A third specimen, which has very numerous densely aggregated spicules, has the zooids twice as large (0.1 to 0.12 mm.) and filled with a multitude of small nuclei.

*S. alveolatum* was obtained by the "Challenger" off Juan Fernandez.

#### SPHÆROZOOM GEMINATUM, *Haeckel*.

*Sphærozoum geminatum*, Haeckel, The Radiolaria, Chall. Rep., Zool., xviii., 1887, p. 45, pl. iv., fig. 4.

One specimen. Originally obtained by Haeckel in the Indian Ocean.

COLLOSPHÆRA HEDLEYI, *sp. nov.*

(Plate liii., fig. 6).

The tests are nearly completely spherical, with a number of short tubes irregularly scattered among small apertures which are less than half the diameter of the intermediate spaces. The tubes are never dilated externally, but always gradually decrease in diameter distally. There are about ten of them in each hemisphere, and about fifteen or sixteen of the small apertures in each half meridian. The intra-capsular protoplasm occupies only a small part of the space enclosed by the shell (about half the diameter). There are numerous Alge within the shell. The diameter of the shell is 0.09 mm. The length of the tubes is 0.12; and their width at the base about the same. The small apertures are 0.05 mm. or less.

This species is distinguished from *S. socialis*, Haeckel, by the greater number of the tubes and the smallness of the other apertures. *S. fragilis*, Haeckel, which was obtained at the "Challenger" Station 165, differs widely in having tubes all over the surface.

COLLOSPHÆRA GLOBULARIS, *Haeckel.*

*Collosphaera globularis*, Haeckel, The Radiolaria, Chall. Rep., Zool., xviii., 1887, p. 94.

One specimen of this widely-distributed species.

COLLOSPHÆRA HUXLEYI, *J. Müller.*

*Collosphaera huxleyi* (J. Müller), Haeckel, Die Radiolarien, Eine Monographie, 1862, p. 534, pl. xxxiv., figs. 1-11; The Radiolaria, Chall. Rep., Zool., xviii., 1887, p. 96.

Several specimens.

COLLOSPHÆRA UNIFORMIS, *sp. nov.*

(Plate liii., fig. 7).

The tests in this species are nearly regular, thin-walled spheres, perforated by rounded apertures, about ten in the half meridian, the intervals, for the most part broader than the apertures. There is usually only one larger well-defined circular aperture with a raised margin; sometimes there are two of these larger apertures. They obviously correspond to the tubes of *Siphonosphæra*, but are much less prominent. The tests are 0.06 mm. in diameter; the small apertures about 0.05 mm., intervals about 0.01 mm.; the larger apertures 0.01.

In the presence of the single larger aperture this species resembles *C. pyriformis*, Haeckel, but differs widely from it in the shape and size of the test and the dimensions of the apertures.



THE RESULTS OF DEEP-SEA INVESTIGATION IN THE  
TASMAN SEA.

3.—MOLLUSCA FROM EIGHTY FATHOMS OFF NARRABEEN.

By C. HEDLEY, Conchologist.

(Plates liv.-lvi.)

The fourth collection from the continental shelf of this coast I have been privileged to examine was discussed in the last issue of this serial. The fifth forms the subject of the present article. It was obtained under the circumstances above related, on 7th June, 1906, in a single haul of the bucket dredge in eighty fathoms, twenty-two miles east of Narrabeen, New South Wales.

Probably the alluvial of the Hawkesbury River is here spread by the prevailing current, for at this point the continental shelf extends in an unusually broad terrace. A depth of two hundred and fifty fathoms is attained at the same distance east of Botany Heads, while six hundred fathoms are reached south of Ulladulla at no greater distance off the land.

According to the "Challenger" observations, long continued west winds push the great warm current beyond this station, but usually its stream sweeps over the position. A rich fauna inhabits this spot. In all I have separated two hundred and forty species of shells, a total far greater than was realised by the best haul of the voyage of the "Challenger." This result is partly due to the productive nature of the ground, and partly to the efficiency of the bucket dredge as a collecting tool.

Assuming that we have here the entire molluscan fauna of three square feet of the sea floor, it is interesting to speculate what proportion of a fauna extending over thousands of square miles of continental shelf, subsists on three square feet. If we counted the plants of three square feet on a river bank, what proportion would they represent of the total flora of the valley? I am inclined to suppose that the cases are not parallel, that a square foot of the sea floor contains a larger proportion of the fauna of a square mile than happens on land. This is supported by the continuity of fossil zones elaborated by modern palaeontologists, and is deducible from the uniformity of conditions in

deep water. I am struck by the repetition in the "Miner's" haul of most species taken off Wollongong, fifty miles south: and off Cape Byron, three hundred and sixty miles north. But if the series before me represents a tenth or even a quarter of all the mollusca of the continental shelf, then we are grasping a fauna as rich or richer than any known.

Of this collection many apparently new are too imperfect for description. Others are suitable for publication but time has not allowed the preparation of drawings and descriptions. As species observed in previous dredgings are here first introduced, so I shall hope for a future opportunity to publish those now put aside.

Five years ago a collection made anywhere from our continental shelf would have presented quite thirty per cent. of new species. This might fairly be ranked as a new fauna. As collections are described, the proportion of novelties in any particular haul will decrease. When reduced to three or four per cent. we might claim to have a fair knowledge of that fauna. A high proportion, about sixteen per cent., appears in the present collection, consequently much work is to be performed before we gain a tolerable acquaintance with the mollusca from 20-100 fathoms off Sydney.

In the first of these reports<sup>1</sup> I drew attention to the appearance in a recent state, of several species previously known as Tertiary fossils. I now add to these *Trivia avellanoides*, McCoy. Dr. J. C. Verco, who is publishing details, informs me that the difference between my *Astele bilix* (now removed to *Basilissa*) and Tate's *Seguenzia radialis* are hardly more than varietal. When a good knowledge of both recent and fossil Australian shells is combined in one brain, the list of survivors will probably be enlarged. The types of the new species are to be preserved in the Australian Museum.

Dr. J. C. Verco is now describing shells from the continental shelf of South Australia and finds there a number of the species here recorded. I have benefited by comparison and interchange of specimens and it is hoped that duplication of work has been avoided.

My thanks are due to Mr. G. M. Goldfinch, a volunteer assistant, who undertook the sorting and separation of the collection. Without his help I should have been unable to present this report at so early a date.

---

<sup>1</sup> Hedley—Mem. Austr. Mus., iv., 5, 1902, p. 287.

The following are the shells identified.

- Acteon austrina*, Watson,  
 „ *rosea*, Hedley.  
*Aduncarca squamea*, Hedley.  
*Admete stricta*, Hedley.  
*Amphithalamus pyramidatus*. Hedley.  
*Amusium thetidis*, Hedley.  
*Arca reticulata*, Gmelin.  
*Architectonica atkinsoni*, Smith.  
 „ *reevei*, Hanley.  
*Aspella unilata*, Hedley.  
*Athanta fusca*, Eydoux and Souleyet.  
 „ *inclinata*, E. & S.  
 „ *rosea*, E. & S.  
*Atys prunsa*, Hedley.  
  
*Basilissa radiata*, Tate.  
*Batharca perversidens*, Hedley.  
*Bathytoma agnata*, Hedley and Petterd.  
*Bulla incommoda*, Smith.  
  
*Cadulus spectus*, Tate and May.  
*Cancellaria scobina*, Hedley and Petterd.  
*Capulus devotus*, Hedley.  
*Carditella angasi*, Smith.  
*Cardium pulchellum*, Gray.  
*Carolina inflata*, Leseur.  
 „ *longirostris* v. *angulata*, Souleyet.  
 „ „ v. *strangulata*, Hedley.  
 „ *quadridentata*, Leseur.  
 „ *tridentata*, Forskal.  
 „ *trispinosa*, Leseur.  
*Chione despecta*, Hedley.  
*Chlamys hedleyi*, Dautzenberg.  
*Cirsonella weldii*, Ten. Woods.  
*Cithna angulata*, Hedley.  
*Clio acicula*, Rang.  
 „ *pyramidata*, Linne.  
 „ *subula*, Quoy and Gaim.  
 „ *virgula*, Rang.  
*Cocculina coercita*, Hedley.  
*Columbarium pagodoides*, Watson.  
*Columbella angasi*, Brazier.  
 „ *plexa*, Hedley.  
*Coralliophila tischkeana*, Dunker.

- Coriarius semiradiatus*, Tate.  
 „ *vitreus*, Hedley.  
*Crassatellites discus*, Hedley.  
 „ *securiforme*, Hedley.  
*Crossea carinata*, Hedley.  
 „ *concinna*, Angas,  
 „ *naticoides*, Hedley.  
*Cryptopora brazieri*, Crane.  
*Cyua delta*, Tate and May.  
 „ *concentrica*, Hedley.  
 „ *particula*, Hedley.  
*Cuspidaria brazieri*, Angas.  
 „ *latesuleata*, Ten. Woods.  
*Cuvierina columuella*, Rang.  
*Cyclostrema inscriptum*, Tate.  
 „ *johnstoni*, Beddome.  
*Cylichna arachis*, Quoy and Gaimard.  
 „ *protumida*, Hedley.  
*Cymatium kampylum*, Watson.  
*Cyrella dalli*, Hedley.  
*Dacrydium fabale*, Hedley.  
*Daphnella crebriplicata*, Reeve.  
 „ *vestalis*, Hedley.  
 „ *sculptior*, Ten. Woods.  
 „ *tasmanica*, Ten. Woods.  
*Dentalium erectum*, Sowerby.  
 „ *lubricatum*, Sowerby.  
*Dimya corrugata*, Hedley.  
*Drillia dilecta*, Hedley.  
 „ *haswelli*, Hedley.  
 „ *multistriata*, Smith.  
 „ *nenia*, Hedley.  
 „ *pentagonalis*, Verco.  
 „ *tricarinata*, Ten. Woods.  
*Emarginula superba*, Hedley and Petterd.  
*Epigrus ischnus*, Tate.  
*Euchelus scabrinsculus*, Angas.  
*Eulina fricata*, Hedley.  
*Euthria tabida*, Hedley.  
*Fascinus typicus*, Hedley.  
*Gafrarium angasi*, Smith.  
*Hemithyris columnus*, Hedley.  
*Hydatina tasmanica*, Beddome.

- Leda miliacea*, Hedley.  
*Lima bassi*, Ten. Woods.  
   " *bullata*, Born.  
*Limacina inflata*, D'Orbigny.  
*Linea murrayi*, Smith.  
*Limopsis brazieri*, Angas.  
   " *tenisoni*, Ten. Woods.  
*Lippistes torcularis*, Ten. Woods.  
*Liotia compacta*, Petterd.  
   " *minima*, Ten. Woods.  
   " *tasmanica*, Ten. Woods var. *scalaris*, Hedley.  
*Lyonsiella quadrata*, Hedley,
- Mangelia emina*, Hedley.  
   " *granulosissima*, Ten. Woods.  
   " *lutaria*, Hedley.  
   " *spica*, Hedley.  
*Margiuelia allporti*, Ten. Woods.  
   " *brazieri*, Smith.  
   " *lavigata*, Brazier.  
   " *multiplicata*, Tate and May.  
   " *ochracea*, Angas.  
   " *simsoni*, Tate and May.  
   " *stanislaus*, Ten. Woods.  
   " *stilla*, Hedley.  
   " *strangei*, Angas.  
   " *whani*, Pritchard and Gatliff.
- Mathilda decorata*, Hedley.  
*Mitra scalariformis*, Ten. Woods.  
   " *strangei*, Angas.  
   " *tasmanica*, Ten. Woods.  
*Mitromorpha alba*, Petterd.  
*Modiola australis*, Gray.  
   " *linea*, Hedley.  
*Modiolaria splendida*, Dunker.  
*Monilea urata*, Hedley.  
   " *philippensis*, Watson.  
*Murex acanthopterus*, Lamarek.  
*Myadorn albida*, Ten. Woods.
- Nassa jacksoniana*, Quoy and Gaimard.  
*Nucula obliqua*, Lamarek.
- Odostomia simplex*, Angas.  
*Omalaxis meridionalis*, Hedley.  
*Orygyrus kerandrenii*, Lesson.

- Philobrya inornata*, Hedley.  
 „ *pectinata*, Hedley.  
 „ *tatei*, Hedley.  
*Philine teres*, Hedley.  
 „ *trapezina*, Hedley.  
*Pleurotomella fustosa*, Hedley.  
 „ *repratrica*, Hedley.  
*Polinices beddomei*, Johnston.  
 „ *subcostata*, Ten. Woods.  
 „ *umbilicata*, Quoy and Gaim. var.  
*Poroleda ensicula*, Angas.  
*Poromya lavis*, Smith.  
*Pronucula decorosa*, Hedley.  
 „ *minuta*, Ten. Woods.  
*Puncturella demissa*, Hedley.  
*Rissoa bicolor*, Petterd.  
 „ *filocincta*, Hedley and Petterd.  
 „ *integella*, Hedley.  
 „ *novariensis*, Frauenfeld.  
 „ *olivacea*, Dunker.  
*Rissoina elegantula*, Angas.  
*Rochfortia acuminata*, Smith.  
 „ *angasi*, Smith.  
 „ *luctea*, Hedley.  
*Sarepta obolella*, Tate.  
*Scala distincta*, Smith.  
 „ *jukesiana*, Forbes.  
 „ *levifoliata*, Murdoch and Suter.  
 „ *translucida*, Gatliff.  
*Schismope atkinsoni*, Ten. Woods.  
*Scissurella australis*, Hedley.  
*Sirius badius*, Ten. Woods.  
*Stiva ferruginea*, Hedley.  
*Tellina tenuilirata*, Sowerby.  
*Terebratulina radula*, Hedley.  
*Thraciopsis arenosa*, Hedley.  
*Trigonia margaritacea*, Lamarck.  
*Trivia avellanoides*, McCoy.  
*Trophon goldsteini*, Ten. Woods.  
 „ *laminatus*, Petterd.  
 „ *simplex*, Hedley.  
 „ *stimuleus*, Hedley.  
*Turritella opulenta*, Hedley.  
 „ *smithiana*, Donald.

- Turritella sophia*, Brazier.  
 „ *subsquamosa*, Dunker.  
*Typhis syringianus*, Hedley.  
 „ *philippensis*, Watson.  
*Venericardia caratica*, Hedley.  
 „ *dilecta*, Smith.  
*Vermicularia nodosa*, Hedley.  
 „ *waitoi*, Hedley.  
*Verticordia valosa*, Hedley.  
 „ *australiensis*, Smith.  
*Voluta nodulata*, Lamarck, var.  
*Xenophora tatei*, Harris.

COCCULINA COERCITA, *sp. nov.*

(Plate liv., figs. 1, 2).

Shell small, thin, almost symmetrical, slightly elevated, very narrow. Colour white. Apex prominent, smooth, inrolled, two-whorled, situated a little behind the centre of the shell. Anterior and posterior slope about equal. Sculpture, slight concentric growth lines. Edge of aperture sharp, smooth; sides straight; ends rounded. Length, 4·6; breadth, 1·3; height, 1·15mm.

The present collection contained a single specimen, another was dredged by Mr. W. F. Petterd and myself in 300 fathoms twenty-seven-and-a-half miles east of Sydney.

PUNCTURELLA DEMISSA, *Hedley*.

(Plate liv., figs. 3, 4, 5).

*Puncturella demissa*, Hedley, Rec. Austr. Mus., v., 2, 1904, p. 93, f. 19.

This species was originally described from Foveaux Strait, New Zealand. Its range is now extended to Australia. The example dredged by the "Miner" is larger than the type, being 1·5 in height, 2·5 in length, and 0·9 mm. in breadth. The surface is clothed with a rather caducous ochraceous epidermis disposed in oblong grains. When stripped of the epidermis the white surface of the shell shows no trace of these grains, and would readily pass for a different species. Towards the margin some specimens have broad shallow radial undulations. A specimen from off Port Stephens is in this Museum; the "Thetis" took it in 63-75 fathoms off Port Kembla, and I have dredged it in 20 fathoms in Wreck Bay, N. S. Wales.

SCALA LEVIFOLIATA, *Murdoch & Suter.*

*Scala levifoliata*, Murdoch and Suter, Trans. N. Zeal. Inst., xxxviii., 1906, p. 296, pl. xxv., f. 35, 36.

A single shell from the "Miner's" haul, compared with a cotype of the New Zealand species, has the peripheral carina less pronounced, and carries above it an additional carina, which gives the Australian shell a more rounded whorl. It is however, identical in other respects. This entry is an addition to the Australian fauna.

SCALA TRANSLUCIDA, *Gatliff.*

*Scala translucida*, Gatliff, Proc. Roy. Soc. Vict., (n.s.), xix., 1906, p. 2, pl. i., f. 3, 4.

An imperfect shell from off Narrabeen agrees with Victorian examples kindly sent me for the purpose of comparison by Mr. J. H. Gatliff.

EULIMA FRICATA, *sp. nov.*

(Plate lv., fig. 14).

Shell sub-cylindrical, scarcely tapering, blunt at either end. Whorls six, first dome-shaped. Colour: apical whorls white opaque, lower semitransparent, permitting the axis to be clearly seen through the wall. Suture, above scarcely distinguishable, below linear. Aperture regularly pyriform, a slight callus on the columella. Length, 4.25; breadth, 1.15 mm.

Two specimens occurred. This is closely allied to *E. pavillus*, Hedley<sup>2</sup>, from which it differs by being nearly twice as large and by having a longer narrower aperture.

CROSSEA NATICOIDES, *sp. nov.*

(Plate liv., figs. 6, 7).

Shell small, turbinate, solid. Whorls, four rounded. Colour cream. Sculpture none, surface smooth and polished. Umbilicus deep and narrow, its margin a faint basal funicle. Aperture entire circular, double-edged, on its right lower margin the low arched butt-end of the basal funicle, then a broad thick callus tongue, probably marking the termination of a second inner funicle, and reaching half-way across the umbilicus; lastly a similar but smaller callus pad laid upon the preceding whorl. Height, 2.35; major diam., 3.0; minor diam., 2.15 mm.

<sup>2</sup> Hedley—Rec. Austr. Mus., v., 2, 1904, p. 96, f. 24.



A few specimens.

Most of the genus are cancellate; the present with *C. carinata*, Hedley<sup>3</sup> and *C. glabella*, Murdoch<sup>4</sup>, are smooth. The latter is remarkable for a double basal funicle. In *C. naticoides* a second funicle appears to exist also, but the inner is swallowed by the umbilicus and its presence is only indicated by the callus on the aperture. The outer funicle is unusually faint, the basal aspect of a young shell (Pl. liv., fig. 7) exhibits the best developed funicle before me.

*CITHNA ANGULATA*, *sp. nov.*

(Plate Iv., fig. 16).

Shell small conical, thin polished perforate. Colour: some individuals milk white, others hyaline with a yellow apex. Whorls five, compactly coiled, with rather flat sides, parted by deeply impressed sutures. Protoconch not particularly distinguished. Sculpture: a sharp elevated cord accentuates the peripheral keel, above it and on the spire occur a few faint irregular radial ribs. Aperture pyriform, anteriorly sub-channelled, outer lip produced medially, thin at the edge, but fortified remotely by a slight external rib varix. Columella long and nearly straight, its reflection reaching partly over the umbilicus. Base rounded. Umbilicus variable, best shown in adults, a narrow furrow circumscribed by a ridge which runs to the anterior extremity of the shell. Length, 2·9; breadth, 1·85 mm.

The genus *Cithna*, being Adamsian, was confusedly framed as Dr. Watson<sup>5</sup> has indicated. I have not had the advantage of examining authentic specimens, but have based my reference of our species to *Cithna* on a beautiful figure by Dautzenberg.<sup>6</sup>

The above described is one of the commonest shells on the continental shelf. Besides the present station it is represented in the Museum from off Port Stephens (Prof. Haswell, 1880); 41·50 fath. off Cape Three Points (Thetis); 54·59 fath. off Wata Mooli (Thetis); 63·75 fath. off Port Kembla (Thetis), and 100 fath. off Wollongong (Halligan and Hedley). No *Cithna* have previously been noticed in Australia.

<sup>3</sup> Hedley—Mem. Austr. Mus., iv., 6, 1903, p. 345, f. 71.

<sup>4</sup> Murdoch—Trans. N.Z. Inst., xxxvii., 1905., p. 225, pl. viii., f. 16, 17.

<sup>5</sup> Watson—Chall. Rep., Zool., xv., 1886, p. 519.

<sup>6</sup> Dautzenberg—Result. Camp. Monaco, Fas. i., 1889, pl. ii, f. 8.

*TURRITELLA OPULENTA, sp. nov.*

(Plate liv., fig. 9).

Shell small, glossy, tall and slender. Whorls ten, two of which form the protoconch. Colour, irregular pale brown marbling on a milk white ground. Sculpture: the upper whorls are strongly bicarinate by two projecting spirals which evenly divide the height of the whorl into quarters. On the lower whorls these keels are less conspicuous. About the eighth whorl a spiral thread is intercalated above, between and below the keels; these increase with the whorls, but fail to attain the size of the major spirals. Fine close-set radial riblets traverse every adult whorl, above they form a coarse lattice with the carinae; on the older whorls they merely raise small beads on the keels and intermediate threads; on reaching the base they cease abruptly. Base bounded by a strong smooth spiral, within which are concentrically arranged four faintly raised spirals. Along the suture a crack or fissure is interposed between the basal rib of the upper whorl and the beaded thread which forms the summit of the succeeding whorl. Protoconch smooth, globose. Aperture ovate, angled above, effuse below, lip sharp, columella straight, slightly thickened. Length, 6; breadth, 2 mm.

This species appears to be common and generally distributed upon our continental shelf. Besides the present station it has occurred in 41-50 fathoms off Cape Three Points (type); in 250 and 300 fathoms off Sydney; in 50-52 fathoms off Botany Heads; in 55-56 fathoms off Wollongong, and in 63-75 fathoms off Port Kembla.

The sculpture is subject to considerable variation; in some examples the spiral sculpture is less, and the radial more prominent than in the individual figured.

Its nearest ally would seem to be *Turritella parva*, Angas,<sup>7</sup> to which in size and shape it nearly approximates, but from which its radial sculpture and sub-channeled anterior aperture effectually divides it.

*VERMICULARIA NODOSA, sp. nov.*

(Plate liv., fig. 8).

Shell small, very solid. Colour gray (? faded). Whorls three, rapidly increasing, coiled adherent to a foreign body, except a third of the last whorl, which is free and semi-erect. Sculpture: thick out-standing radial ribs, about twenty on the last whorl,

<sup>7</sup> Angas—Proc. Zool. Soc., 1877, p. 174., pl. xxvi., f. 17.

which broaden to the periphery, narrow to the suture, and are parted by deeply excavate interstices of corresponding breadth. Aperture circular, its lip constituted by the final rib. Major diam., 2.25; minor diam., 1.65 mm.

Among described species the Californian *V. avellum*, Morch, alone resembles this. Judging from the figure the American species has finer closer ribs.

TRIVIA AVELLANOIDES, *McCoy, sp.*

(Plate lv., figs. 17, 18).

*Cypræa avellanoides*, McCoy, Ann. Mag. Nat. Hist. (3), xx., 1867, p. 436. *Id.*, Prod. Pal. Vict., dec. iii., 1876, p. 36, pls. xxviii., xxix., f. 3. a-c.

*Trivia avellanoides*, Harris, Cat. Tert. Moll. Brit. Mus., i., 1897, p. 213.

Two specimens, one perfect, the other broken, are the first of this species reported as recent. The perfect specimen, of which I offer a figure, is 4.5 mm. in length, has thirty-seven thread-like riblets which are interrupted by a smooth, not excavate, dorsal space. Its colour is white, the smooth dorsal area more opaque than the rest.

All authors who have dealt with the species comment on its extreme variability. The recent example, though not typical, certainly intergrades with a small delicately sculptured form of the fossil. Mr. R. Etheridge, who kindly checked my comparison of the "Miner" shell with a series of Victorian fossils concurred in this determination.

The species is embraced in a group distinguished by a thin shell, wide aperture, and a narrow outer lip, for which Jousseaume has proposed<sup>9</sup> the name *Triviella*. Its members are distributed in South Africa, Southern Australia and New Zealand.

TROPHON STIMULEUS, *sp. nov.*

(Plate lv., fig. 19).

Shell minute, thin, prickly, ovately-fusiform, angled at the shoulder. Whorls five, two of which compose the glossy conical protoconch. Colour white. Sculpture: thin close laminate varices, about twelve to a whorl, ascend the spire obliquely, produced on the shoulder in a claw projecting to the suture, crumpled

<sup>8</sup> Tryon—Man. Conch., viii., 1886, pl. 49, f. 34.

<sup>9</sup> Jousseaume—Bull. Soc. Zool. Fr., ix., 1884, p. 99.

into folds by a ridge on the shoulder and two lesser ones below the periphery, the shoulder folds rise in hollow thorns. On the base the varices cease. Aperture round, the outer lip projecting in a broad squamose varix, the inner expanding over the axis. Canal short, broad and open. Length, 3.5; breadth, 2.1 mm.

As our investigations are pushed into colder water it may be expected that so characteristic an Antarctic group as *Trophon* will appear in force. Among Australian species, the present diminutive form is most like *T. laminatus*, Petterd,<sup>10</sup> than which it is shorter, comparatively broader, with more prominent and wider spaced varices. In all stages a plain distinction is furnished by the protoconch, which in *laminatus* is abruptly truncate, in *stimuleus* conical.

ASPELLA UNDATA, *sp. nov.*

(Plate Iv., fig. 15).

Shell small, solid, ovate. Whorls six, of which two form the protoconch. Colour: cream, with a pale purple-brown, narrow peripheral zone, which re-appears within the aperture. Sculpture: each whorl has eight or nine discontinuous rib-varices, which begin with a minute, forwardly-directed hook under the suture, swell more steeply before than behind, their interstices, broad wave-troughs, describe a sigmoid flexure across the whorls, fade across the base and terminate as scales upon the snout; the general surface is smooth. Protoconch turbinate, glassy. Aperture sub-rhomboidal, pinched above, exteriorly with a well developed varix, lined with a narrow, projecting lip. Columella bent; inner lip well-developed, rising over a short axial groove. Anterior canal very short and broad. Length, 6.5 mm.; breadth, 3 mm.

A few specimens, mostly broken.

The genus *Aspella* was introduced by Morch<sup>11</sup> for *Ranella anceps*, Lamk., a species which in Eastern Australia ranges from Torres Strait to Sydney. Dr. W. H. Dall<sup>12</sup> revised the genus, and transferred it to the Muricidae, near *Trophon*. The absence of the bilateral varices gives the novelty an aspect strange to the genus, but the difference is one of degree rather than of kind. In this respect *Aspella senex*, Dall<sup>13</sup> appears to connect these species.

<sup>10</sup> Petterd—Journ. of Conch., iv., 1884, p. 136.

<sup>11</sup> Morch—Malak. Blatt., xxiv., 1877, p. 24.

<sup>12</sup> Dall—Bull. Mus. Comp. Zool., xviii., 1889., pp. 206-10.

<sup>13</sup> Dall—Trans. Wagner Free Inst. Sci., iii., 1903, pl. ix., f. 14.

MARGINELLA ALLPORTI, *Ten. Woods.*

*Marginella allporti*, Ten. Woods, Proc. Roy. Soc. Tasm., 1875 (1876), p. 28.

Further study of the form I distinguished as *Marginella kemblensis*<sup>14</sup> has convinced me that it is not separable from the Tasmanian species, whose name must therefore supersede it.

ADMETE STRICTA, *sp. nov.*

(Plate liv., fig. 10).

Shell minute, thin, ovately fusiform, deeply constricted at the sutures. Whorls five, rather tumid medially, flattened above contracted at the base; first whorl dome shaped. Sculpture: above radials predominate, below spirals prevail. The radials are prominent undulating ribs, numbering nine on the antepenultimate whorl; they gradually diminish in size as growth proceeds, and vanish on the base. The spirals amount to thirteen on the last whorl, and seven on the penultimate; they consist of sharp elevated cords, over-riding the radial ribs and parted by flat interstices of twice their width; the interstices are finely, transversely grooved. Aperture narrowly reniform, rounded above and below outer lip sharp, columella ending in a single broad fold, whence a callus layer proceeds which overlies a narrow shallow, umbilical groove. Length, 4.5; breadth, 1.76 mm.

A single specimen (the type) from the present station, another imperfect example from 100 fathoms, sixteen miles east of Wollongong.

The genus *Admete* is now first announced from Australian waters. The species is unlike any recent shell, but judging from Prof. Tate's figures<sup>15</sup> it resembles the Tertiary *Cancellaria miera* and *C. turriculata*.

PLEUROTOMELLA FASTOSA, *sp. nov.*

(Plate lv., fig. 21).

Shell small, rather solid, slender, fusiform. Whorls eight-and-a-half, of which six form the protoconch. Colour: adult whorls straw yellow, protoconch cinnamon brown. Sculpture: running below the suture the adult whorls have a spiral thread which ascends into the protoconch for two whorls; this is followed by a broad concave fasciole, margined in turn by a sharp projecting

<sup>14</sup> Hedley—Mem. Austr. Mus., iv., 6, 1903, p. 365, f. 88.

<sup>15</sup> Tate—Trans. Roy. Soc. S. Austr., xi., 1889, p. 158, pl. x., f. 8, 14.

keel which determines an angle in the contour of the shell. Half way between the major keel and the suture runs a smaller keel. On the last whorl there are about fourteen spirals, gradually diminishing anteriorly, below the major keel. The fasciole is ornamented by spaced, delicate, concave riblets. Fine arcuate growth lines appear in the interstices of the spiral keels. In the protoconch, the first whorl and a half are small, rounded, and spirally striate; the rest protrude medially, and are crossed by fine sharp radial riblets, which on the last whorl number twenty-two. Their interstices are latticed by spiral threads.

One example of which the aperture is defective. Length, 5 mm.; breadth, 1.9 mm.

The figures of *Mangilia comatotropicis*, Dall,<sup>16</sup> present considerable analogy to our species, but appear to be narrower, with fewer bolder spirals.

If the characters be analysed for generic disposal in the perplexing maze of the Pleurotomidæ, the most prominent features resolve in the elaborately sculptured protoconch, and the broad sub-sutural fasciole, indicative of a deep sinus. These features are repeated, though associated with different form and sculpture, by my *Pleurotoma vepatica*.<sup>17</sup>

Verrill's *Pleurotomella*,<sup>18</sup> while not exactly conforming to the requirement appears to come nearest, and is therefore here employed.

#### MANGELIA LUTARIA, *sp. nov.*

(Plate liv., figs. 11, 12).

Shell small, solid, cylindrical, abruptly truncate above. Whorls five, three forming the protoconch, sloping on the shoulder, perpendicular at the side, and concave at the base. Colour grey (? bleached). Sculpture: deep narrow pits are formed by the intersection of radial and spiral sculpture; radials strong, prominent, perpendicular, continuous ribs, about a dozen to a whorl, knotted at the crossing of the spirals, which number four on the upper and twelve on the lower whorl, the spiral defining the basal angle larger and more prominent. Protoconch: first whorl wound oblique to the axis of the main shell, the second overhanging the third, appearing as if the apex was wrapped in a turban. Aper-

<sup>16</sup> Fischer and Dautzenberg—Mem. Soc. Zool. Fr., ix., 1896, p. 419, pl. xvii., f. 15.

<sup>17</sup> Hedley—Mem. Austr. Mus., iv., 6, 1903, p. 384, f. 97.

<sup>18</sup> Verrill—Am. Journ. Sci. (3), v. 1872, p. 15; Cossmann—Essais de Paléontologie comparée, ii., 1896, p. 133.

ture long, narrow, fortified by a heavy varix, in the anterior angle of which is excavated a deep sinus. Columella nearly straight, overlaid by a slight callus. Anterior canal very short and wide. Length, 3·0; breadth, 1·15 mm.

One specimen.

This species appears nearest related to *M. cancellata*, Beddome,<sup>19</sup> from which, judging by the figure,<sup>20</sup> it differs by having a whorl less and by the cancellate sculpture continuing below the more acute basal angle. In *Drillia telescopialis*, Verco, weaker and more numerous radials enclose nearly square pits, but in *M. lutraria* they are much longer than broad.

#### MANGILIA SPICA, *sp. nov.*

(Plate lv., fig. 20)

Shell small, slender, conical, base excavate. Whorls six-and-a-half, including a protoconch of two whorls and a half. Colour: protoconch cinnamon, adult whorls white ribbing on a buff background. Sculpture: eight prominent undulating radial ribs descend the spire obliquely, and terminate abruptly at the periphery of the last whorl. They are over-ridden by five strong spiral cords, the peripheral the largest, and marking an obscure angle on each whorl. Between the cords, and broader than them, are deep, radially-striated interstices. On the base are about six widely-spaced spiral cords. Aperture narrow, posterior sinus indistinct, canal short, broad, open. Length, 4·1; breadth, 1·25 mm.

Two specimens from off Narrabeen; another from 100 fathoms, sixteen miles east of Wollongong.

#### DRILLIA HASWELLI, *sp. nov.*

(Plate lv., fig. 22).

Shell small, fusiform, blunt at each end, rather thin, scarcely opaque. Whorls five and a half, the first two constituting a glassy dome-shaped protoconch, the rest rather inflated, constricted at the sutures, excavate at the base. Colour chalk white, rather glossy when fresh. Sculpture: fine spiral threads, one more prominent than the rest defines a slight angle on the shoulder. On the last whorl there are about four above and twenty below the angle. The spirals are crossed by arcuate growth lines. Aper-

<sup>19</sup> Beddome—Proc. Roy. Soc. Tas., 1882 (1883), p. 167.

<sup>20</sup> Tate and May—Proc. Linn. Soc. N. S. Wales., xxvi., 1901, pl. xxiv., f. 27.

ture slightly ascending, narrow above, rounded within a deep notch, fortified without by a heavy varix; a thin callus is spread on the inner lip. Canal short and broad. Length, 5.5; breadth, 1 mm.

This species is related to *D. tricarinata*, Ten. Woods, from which it is readily separable by smaller size, broader form, and more delicate sculpture. *D. laswelli* is represented by numerous specimens in the "Miner" haul, and seems to be generally distributed on our continental shelf. The "Thetis" took it in 41-50 fathoms off Cape Three Points, and I have dredged it in 100 fathoms off Wollongong and 300 fathoms off Sydney.

DRILLIA PENTAGONALIS, *Verco, var.*

*Drillia pentagonalis*, Verco. Trans. Roy. Soc. S. Austr., xx., 1896, p. 222, pl. vii., f. 2, 2 a.

This is a new record for Eastern Australia. Observing that the "Miner" shells differ from the original description by having seven ribs instead of five, and by being of larger size, I submitted them to the author of the species. Dr. Verco kindly replied:—22 Sept, 1906. "Your *Drillia* is I think my *D. pentagonalis*. Yours is somewhat larger, and its angles do not run continuously from end to end of the shell as in my type, but I feel sure it is only a variant."

MITROMORPHA ALBA, *Petterd, sp.*

*Columbella alba*, Petterd, Journ. of Conch. ii., 1879, p. 104.

*Mitromorpha alba*, Tate and May, Proc. Linn. Soc. N. S. Wales, xxvi., 1901, p. 455. *M. flindersi*, Pritchard and Gatliff, Proc. Roy. Soc. Vict., xii., 1899, p. 104, pl. vii., f. 6; *Id. op. cit.*, xviii., 1905, p. 51.

A single specimen which agrees exactly with Victorian examples.

DAPHNELLA SCULPTIOR, *Ten. Woods, sp.*

*Clathurella sculptior*, Ten. Woods, Proc. Roy. Soc. Tas., 1878 (1879), p. 38. *Id.*, Tryon, Man. Conch., vi., 1884, pl. xxxii., f. 27. *Id.*, Tate and May, Proc. Linn. Soc. N. S. Wales, xxvi., 1901, pp. 371, 446. *Drillia legrandi*, Beddome, Proc. Roy. Soc. Tas. 1882 (1883), p. 167. *Id.*, Pritchard and Gatliff, Proc. Roy. Soc. Vict., xii., 1900, p. 178. *Id.*, Hedley, Proc. Linn. Soc. N. S. Wales., xxxv., 1900, p. 509, pl. xxv., f. 1, 2, 3. *Daphnella bitorquata*, Sowerby, Proc. Mal. Soc., ii, 1896, p. 27, pl. iii, f. 9.



This species is already known from Tasmania, South Australia and Victoria. Two individuals in the present haul extend the known range to this State.

CAVOLINIA LONGIROSTRIS, *Lesueur*, var. STRANGULATA, var. nov.

(Plate liv., fig. 13).

This differs from the typical form by sudden lateral contraction of the rostrum, which distally expands in a spout. In the typical form the rostrum is produced more gradually from the anterior dorsal margin than in the variety. In var. *strangulata* the posterior lateral angles are less developed. Nearest stands the var. *angulata*, Souleyet,<sup>21</sup> which has the rostrum not spread distally, and contracted from back to front instead of from side to side, it also agrees in the diminutive posterior angles. Boas states<sup>22</sup> that he has traced *angulata* through a series of transitions into *longirostris*. But this should not reduce a well-marked variety to an absolute synonym. Souleyet's form also occurs on the coast of N. S. Wales.

I have not met this variety alive, and only know it from dead specimens dredged from the bottom. Besides the present station it has occurred at sixteen miles east of Wollongong, and twenty-three miles east of Sydney. Examples from the neighbourhood of the Great Barrier Island, New Zealand, are referred to<sup>23</sup> as a variation of *C. longirostris*. Var. *strangulata* seems a southern form. Though typical *C. longirostris* has occurred to me plentifully along the Queensland Coast, as at the Palm Islands, Green Island and Thursday Island, I have not seen the variety from the north nor the typical form from the south of Sydney.

OXYGYRUS KERAUDRENI, *Lesueur*, sp.

*Atlanta keraudrenii*, Lesueur, Journ. de Phys., lxxxv., 1817, p. 391, pl. ii. *Oxygyrus keraudrenii*, Smith, Chall. Rep., Zool., xxiii., 1888, p. 46.

Two imperfect specimens were taken on this trip. Previously the "Thetis" had obtained fragments of it off Port Kembla in 63-75 fathoms, and, in company with Mr. W. F. Petterd, I dredged another broken shell, twenty-three miles east of Sydney. The genus seems to be unknown hitherto from Australian waters.

<sup>21</sup> Souleyet—Zool. Bonite., ii, 1852, p. 152, pl. v., f. 1-6.

<sup>22</sup> Boas—Spolia Atlantica, 1886, p. 211.

<sup>23</sup> Hedley—Trans. N. Z. Inst., xxxviii., 1906, p. 76.

*MODIOLA LINEA, sp. nov.*

(Plate lvi., figs. 23, 24, 25).

Shell small, thin sub-cylindrical, smooth and glossy, anteriorly slightly produced and angled, posteriorly rounded, dorsal and ventral margins parallel. Umbo low, a little incurved, at a fifth of the total length. Colour white, with a few small, scattered, brown dashes. Sculpture regular, concentric growth striae, which posteriorly are traversed by a few faint impressed rays. Periostracum thin, polished. Hinge edentulous. Length, 5.75; height, 2.5; depth of single valve, 0.9 mm.

In our fauna the novelty is nearest related to *Modiola arborescens*, Chemnitz,<sup>24</sup> which is far larger, and even in its young stages, of quite different contour.

*CRASSATELLITES DISCUS, sp. nov.*

(Plate lvi., figs. 26, 27).

Shell small, thin, sub-quadrate, lenticular, inequilateral, the posterior side being twice the length of the anterior; dorsal and posterior margins straight, ventral slightly rounded, anterior produced. Colour: buff or vinous, with a few broken radial streaks. Sculpture: umbo and neighbouring area smooth, followed by about a dozen sharp, even, elevated, concentric folds, parted by equal interspaces. Over these run a microscopic sculpture of extremely fine concentric scratches. Lunule and dorsal area elongate and narrow. Inner margin of valve smooth and bevelled. Height, 6; length, 7; depth of single valve, 1.7 mm.

A group of small, short *Crassatellites* from East Australia much resemble one another. Single specimens seen separately are difficult to distinguish, but a series of each demonstrates that slight though the differences be, they are constant. *C. fulvida*, Angas,<sup>25</sup> is larger; *C. junus*, Hedley,<sup>26</sup> is smaller than *C. discus*; besides colour differences, both are more inflated, stronger ribbed, and the anterior and posterior margins meet at a more acute angle. The former has, the latter has not, small denticles on the inner margin. *C. securiforme*, Hedley,<sup>27</sup> is longer in proportion to height, the nearly straight dorsal margin, almost at right angles with the anterior margin, distinguish it from *C. discus*.

<sup>24</sup> Chemnitz—Conch. Cab., xi., 1795, p. 251, pl. 198, f. 2016-17.

<sup>25</sup> Angas—Proc. Zool. Soc., 1871, p. 20, pl. i., f. 32.

<sup>26</sup> Hedley—Proc. Linn. Soc. N. S. Wales, xxxi., 1906, pl. xxxviii, f. 29-30.

<sup>27</sup> Hedley—Mem. Austr. Mus., iv., 5, 1902, p. 312, f. 53.

This species appears to be the commonest *Crassatellites* on our continental shelf. Besides the present station, where it occurred plentifully, Mr. Halligan and I dredged numerous specimens in 100 fathoms, sixteen miles east of Wollongong. In both these localities it was associated with *C. securiforme*. But the record of *C. securiforme* from 111 fathoms off Cape Byron,<sup>28</sup> is, I regret to say, based on a single valve of *C. discus*.

*MYODORA ALBIDA*, Ten. Woods.

*Myodora albida*, Ten. Woods, Proc. Roy. Soc. Tas., 1875 (1876), p. 160. *M. corrugata*, Verco, Trans. Roy. Soc. S. Austr. xx., 1896, p. 229, pl. viii., f. 1.

This species has not been noted from the coast of New South Wales. A single broken valve was secured by the expedition. A perfect specimen occurs in the Hargreaves collection labelled "outside Sydney Heads." It was probably dredged when a party of Sydney Naturalists were entertained on board H.M.S. "Challenger."<sup>29</sup>

*CORIAREUS*, *gen. nov.*

A genus allied to *Lasora*, with a weaker, less complex hinge, a larger, thinner, radiately sculptured valve clothed with a thick dense epidermis. Type, *C. vitreus*, Hedley; second species, *Montacuta semiradiata*, Tate.<sup>30</sup>

*CORIAREUS VITREUS*, *sp. nov.*

(Plate lvi., figs. 28, 29, 30).

Valve ovate-oblong, slightly inflated, equivalve, closed all round, inequilateral, posterior twice the length of the anterior, highly polished, thin and brittle. Colour, milk white. The epidermis is peculiar: a thick, dense, felted, entire rusty-brown coat, which appears as if some foreign substance had caked on the valves, and which flakes away when dry in irregular masses. Sculpture: a few distant, concentric, raised threads mark rest stages in growth; there are numerous sharply elevated, thin, radial riblets, irregularly disposed and spaced, but chiefly grouped in the centre of the valve; towards the margin additional riblets are intercalated. Hinge:

<sup>28</sup> Hedley—Rec. Austr. Mus., vi., 2, 1906, p. 42.

<sup>29</sup> Spry—Cruise of Challenger, 1876, p. 169.

<sup>30</sup> Tate—Trans. Roy. Soc. S. Austr., 1888., p. 63, pl. xl., f. 2; Hedley—Proc. Linn. Soc. N. S. Wales, 1906, p. 542, pl xxxi., f. 1-2.

in the left valve immediately beneath the prodissoconch there descends obliquely into the valve a prominent thickened ridge, above which is a deep narrow groove, followed by the margin of the valve, which is broadly reflected on the umbo; anteriorly the chondrophore is followed by a slight ridge: in the right valve a thickened posterior tubercle and a slight anterior groove; no lateral teeth occur: the muscular impressions, as is usual in so thin a shell, are invisible; inner margin of valve smooth and bevelled. Length, 6.5; height, 5; depth of single valve, 1.5 mm.

Besides the present station the species occurs in 250 and 300 fathoms off Sydney. The individual figured was obtained in the former station by Mr. W. F. Petterd and myself.

*C. semiradiata*, Tate, was associated with *C. vitreus*, both off Narrabeen and Sydney.

#### ECTORISMA GRANULATA. Tate.

*Ectorisma granulata*, Tate, Trans. Roy. Soc. S. Austr., xv., 1892, p. 127, pl. i, f. 3, 3a.

This species was represented by a valve and some fragments, which latter indicate that the shell attains a length of 20 mm. Examples were recently submitted to Dr. W. H. Dall, who informs me—21 Sept. '06—that it is a *Poromya*, and Tate's genus therefore unnecessary. The specific name is already occupied by Nyst in this genus, and if otherwise unnamed the species requires another designation. The species, however answers fairly to the description of *Poromya lewis*, Smith,<sup>31</sup> obtained in 155 fathoms off Raine Island, N. Queensland. So that until actual comparison can be made it seems better to use Smith's name for our shell than to coin a new one.

#### LYONSIELLA QUADRATA, sp. nov.

(Plate lvi., figs. 31, 32, 33).

Shell small, thin, inflated, oblong, the posterior side much longer than the anterior. Umbo much incurved. Sculpture: irregular faint growth lines are crossed by a few inconspicuous radial furrows, one of which, running from the umbo to the posterior ventral angle, is cut deeper than its fellows; except round the umbo, where they have perhaps been worn away, small close-

<sup>31</sup> Smith—Chal. Rep., Zool., xiii., 1885, p. 55, pl. xi., f. 3.

set, sharply pointed grains bestrew the surface of the shell. Hinge edentulous. Length, 3.75; height, 2.5; depth of single valve, 1.4 mm.

A few separate valves represent a genus new to the Australian fauna. Judging from illustrations *L. abyssicola*, Sars,<sup>32</sup> is nearest, and differs by being larger and higher in proportion to its length. Another single valve was dredged by Mr. G. H. Halligan and myself in 100 fathoms off Wollongong.

*VERTICORDIA VADOSA, sp. nov.*

(Plate lvi., figs. 34, 35, 36, 37).

Shell small, rather solid, compressed, equilateral, sub-circular, sub-spiral. Umbo projecting. Lunule deeply excavate. Sculpture: about ten low, broad, undulating radial ribs; except the umbo, which is smooth, the entire surface is densely covered with minute radially-disposed elevate grains, which increase in size towards the margin; interior nacreous, margin smooth. Height, 2.65; length, 2.8; depth of single valve 0.8 mm.

The species is represented by four separate valves in this collection. Another odd valve was taken by Mr. G. H. Halligan and self in 100 fathoms off Wollongong.

This opportunity is taken of withdrawing the name *Verticordia rhomboidea* proposed<sup>33</sup> for a recent shell. I unfortunately failed to observe that Prof. Tate had already chosen this name for a Tertiary fossil.<sup>34</sup>

Though related, the fossil appears from the description to differ. To avoid confusion I now beg to substitute *Verticordia setosa* as the name of the New Zealand shell. It has already (ante p. 215) been recorded from this coast.

*VERTICORDIA AUSTRALIENSIS, Smith.*

*Verticordia australiensis*, Smith, Chall. Rep., Zool., xiii., 1885, p. 167, pl. xxv., f 6, 6b.

(Plate lvi., figs. 38, 39).

Half-a-dozen mutilated valves correspond to the figure and description of the species taken by H.M.S. "Challenger" in 155

<sup>32</sup> Sars—Moll. Reg. Arct. Norvegiæ, 1878, pl. 20, f. 5.

<sup>33</sup> Hedley—Trans. N. Z. Inst., xxxviii., 1905 (1906), p. 71, pl. ii., f. 12, 13, 14.

<sup>34</sup> Tate—Trans. Roy. Soc. S. Austr., ix., 1886 (1887), p. 149, pl. xiv., f. 14.

fathoms off Raine Island near Cape York, Queensland. It has not been seen since then, and the identification of the "Miner" shells will, if correct, widely extend the geographical range of *V. australiensis*. Whereas the type is  $3\frac{2}{3}$  mm. long, a broken valve figured here is 12 mm. in length. Ours has more lyrae, and I do not discern "a very faint depression at the posterior end from the beaks to the ventral margin." The difference between young and old individuals may reconcile these discrepancies.

THE RESULTS OF 'DEEP-SEA INVESTIGATION IN THE  
TASMAN SEA.

I.—THE EXPEDITION OF H.M.C.S. "MINER."

4. FORAMINIFERAL SAND DREDGED TWENTY-TWO MILES  
EAST OF SYDNEY AT A DEPTH OF EIGHTY FATHOMS.

By E. J. GODDARD, B.A., B.Sc., Biological Laboratory, Sydney  
University.

(Figs. 44-48).

The sand contains a good variety of forms. In the appended list the chief forms present are mentioned. This list is not a complete one, inasmuch as in the abundant material at hand additional forms must be present. It is intended to complete the list subsequently.

The material contains beautiful glauconite casts. This mineral (a hydrous silicate of potash and iron) is very noticeable as in-fillings in the species of *Lagena*, certain members of the Rotalidæ, and especially in the members of the Globigerinidæ. The restriction of the glauconite to these forms is very marked.

By far the most abundant forms present in the sand are members of the Globigerinidæ, the commonest species being *Globigerina bulloides*. There is a good representation of the genera and species of the family and corresponds closely with that in sand dredged off Wollongong at a depth of 100 fathoms.

The genus *Lagena* is very abundant and is represented by a fair number of species. Since such a great number of species of *Lagena* have been described and the naming of new species is objectionable unless some marked character of specific importance is detected, it has been deemed advisable not to name a few new forms whose characters fit in as variations or connecting links between named species.

*Lagena sulcata* is the most abundant form and shows great variation. Many forms—apiculate and winged—with slight and varied differences represent varieties of this species.

Quite a large number of *L. globosa* show an entosolenian tube.

The genus *Nodosaria* is remarkably scarce in the material.

Interesting non-spinous varieties of *Cristellaria calcar* are present. *Polymorphina alveoliniformis*, described by Jensen from

Byron Bay, at a depth of 111 fathoms, is well represented, the specimens being larger than those present in the Byron Bay material.

The Rotalidæ are well represented. A number of species of the Rotalinæ must subsequently be added to the list of those mentioned.

The most abundant member of the Nummulinidæ is *Polystomella mucella*. This species shows great variation. Many specimens have the septal bridges very irregularly developed, approaching in that respect *Polystomella verruculata*.

The occurrence of *Allomorphina trigonula* in the sand is very interesting in connection with the distribution of that form.

The Nubecularidæ are represented chiefly by the genus *Planispirina*.

Although a good number of species of other members of the Miliolininæ have been detected, the individual species are remarkably poorly represented. Fairly common in the sand is a marine Diatom, *Amphora*, sp., allied to *Amphora polygonata*.

The following is a general list of the species obtained so far as at present determined :—

### Family NUBECULARIDÆ.

#### Sub-family MILIOLININÆ.

- Biloculina ringens*, Lamarek.
- Miliolina bicornis*, Walker and Jacob.
- „ *separans*, Brady.
- „ *trigonula*, Lamarek.
- „ *alveoliformis*, Brady.
- Planispirina erigua*, Brady.
- „ sp.
- Spiroloculina arenaria*, Brady.
- „ *teniseptata*, Brady.
- „ *limbata*, d'Orbigny.
- „ *impressa*, Terquem.
- „ *excavata*, d'Orbigny.
- „ *fragilissima*, Brady.
- „ sp.

#### Sub-family PENEROPLIDINÆ.

- Cornuspira involvens*, Reuss.
- Orbitolites complanata*, Lamarek.



*Sub-family* HAUSERININÆ.

- Ophthalmidium inconstans*, Brady.  
 " " (variety oblong in shape).

*Family* ASTRORRHIZIDÆ.*Sub-family* ASTRORRHIZINÆ.

- Astrorhiza arenaria*, Norman.

*Sub-family* SACCAMMININÆ.

- Psammosphæra fusca*, Schulze.

*Sub-family* RHABDAMMININÆ.

- Hyperammia vagans*, Brady.

*Family* TEXTULARIIDÆ.*Sub-family* TEXTULARINÆ.

- Textularia agglutinans*, d'Orbigny.  
 " *sagittula*, DeFrance.  
 " *trochus*, d'Orbigny.  
*Gaudryina subrotundata*, Schwager.

*Sub-family* BULMININÆ.

- Bolivina textularoides*, Reuss.  
 " *pygmaea*, Brady.

*Family* CHILOSTOMELLIDÆ.

- Chilostomella ovoidea*, Reuss.  
*Allomorphina trigona*, Reuss.  
 " sp.

*Family* LAGENIDÆ.*Sub-family* LAGENINÆ.

- Lagena sulcata*, Walter and Jacob.  
 " *orbignyana*, Sequenza.  
 " *sulcata* var. *annularis*, var. nov. (fig. 48)  
 " *plumigera*, Brady.  
 " *sulcata* (apiculate and winged varieties).<sup>1</sup>  
 " *squamose-marginata*, Parker and Jones.

<sup>1</sup> Brady—Chall. Rep., Zool., xlix, pl. lxii.

- Lagena striata*, d'Orbigny.  
 „ *hexagona* var. *lata*, var. nov. (fig. 44).  
 „ *globosa*, Montague.

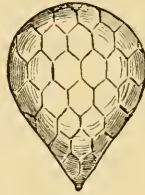

Fig. 44. x 150.

*Sub-family* NODOSARIINÆ.

- Nodosaria scalaris*, d'Orbigny.  
 „ *vertebralis*, Batsch.  
 „ sp.  
 „ *filiformis*, d'Orbigny,  
*Cristellaria crepidula*, Fichtel and Moll (with young in  
 last chamber).  
 „ *calcar*, Linn.  
 „ „ (non spinous variety), (fig. 45).

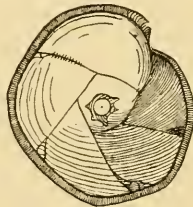

Fig. 45. x 75.

- „ *costata*, Fichtel and Moll.  
 „ *haswelli*, sp. nov. (figs. 46, 47).  
 „ *orbicularis*, d'Orbigny.  
*Froundicularia* sp.

*Sub-family* POLYMORPHININÆ.

- Polymorphina alveoliformis*, Jensen, Proc. Linn. Soc.  
 N. S. Wales, xxix., 4, 1905, p. 821, Pl.  
 xxiii., figs. 8-12.

- Uvigerina pygmaea*, d'Orbigny.  
 „ sp. (forms intermediate between *U. pygmaea*  
 and *U. aculeata*).<sup>2</sup>  
*canariensis*, d'Orbigny

Family GLOBIGERINIDÆ.

- Globigerina bulloides*, d'Orbigny.  
 „ „ var. *triloba*, Reuss.  
 „ *cretacea*, d'Orbigny.  
 „ *limacina*, d'Orbigny.  
 „ *aquilateralis*, Brady.  
 „ sp. (small species with a textularoid arrange-  
 ment of chambers).  
*Orbulina universa*, d'Orbigny.  
 „ *porosa*, Terquem.  
*Hastigerina pelagica*, d'Orbigny.  
*Candeina nitida*, d'Orbigny.  
*Pullenia obliquiloculata*, Parker and Jones.  
 „ *quinquelobata*, Reuss.

Family ROTALIIDÆ

Sub-family SPIRILLININÆ.

- Spirillina limbata*, Brady.  
 „ „ var. *denticulata*, Brady.

Sub-family ROTALINÆ.

- Truncatulina praeincta*, Karrer.  
 „ sp.  
 „ *lobata*, Walker and Jacob.  
 „ *wuellerstorffi*, Schwager.  
 „ *reticulata*, Czjzek.  
 „ *echinata*, Brady.  
*Planorbulina* sp.  
*Discorbina araucana*, d'Orbigny.  
 „ *biconcava*, Parker and Jones.  
 „ *vesicularis*, Lamarek.  
 „ sp.  
 „ *bertheloti*, d'Orbigny.  
 „ *parisiensis*, d'Orbigny.  
*Palvinulina micheliniana*, d'Orbigny.  
 „ *meardi*, d'Orbigny.  
*Anomalina grosserugosa*, Gumbel.  
 „ *ariminiensis*, d'Orbigny.

<sup>2</sup> Brady—Chall. Rep., Zool., xlix, pl. lxxiv., figs. 24-26.

*Rotalia* sp.  
 „ *calcar*, d'Orbigny.

*Sub-family* TINOPORINÆ.

*Polytrema miniaceum*, Linne.

*Family* NUMMULINIDÆ.

*Sub-family* POLYSTOMELLINÆ

*Polystomella macella*, Fichtel and Moll.

„ „ (variety approaching close to *P.*  
*crispa* and *P. subnudosa*).

„ *subnudosa*, Münster.

„ *crispa*, Linn.

*Sub-family* NUMMULITINÆ.

*Operculina ammonoides*, Gronovius.

CRISTELLARIA HASWELLI, *sp. nov.*

(Figs. 46, 47).

Only one specimen of this species has been seen.

The surface is quite smooth, and presents a glistening hyaline appearance.

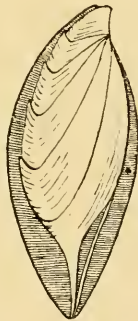

Fig. 46, x 100.



Fig. 47, x 100.

There is a well developed keel on either side. The general arrangement of the chambers resembles that seen in *Cristellaria lata*.

The septal lines are slightly limbate.

Length 3.4 mm. ; breadth 1.6 mm.

Fig. 46 represents the lateral view, and fig. 47 represents the front peripheral aspect.

*LAGENA SULCATA*, var. *ANNULARIS*, *var. nov.*

(Fig. 48).



This resembles *Lagena sulcata* in general characters. The chamber is globular and is produced into an apical spine. The neck is smooth and devoid of any ornamentation. The ridges are fewer in number than in *Lagena sulcata*. There is a well-developed annular ridging towards the aboral end of the test. On this account the variety might be termed

Fig. 48, x 150. *annularis*.

NOTE UPON *MUS TOMPSONI*, RAMSAY.

By ALLAN R. McCULLOCH, Zoologist.

*Mus tompsoni*, Ramsay, Proc. Linn. Soc. N. S. Wales, vi., 1881, p. 763.

The Trustees have received through the repeated good offices of Mr. C. F. Bolton, of Wagga Wagga, N. S. Wales, a fine series of rats under the name *Mus tompsoni*, Ramsay, together with notes upon their habits and colouration. It includes eight males, half of which are black and the others grey, and six females, four black and two grey. Also six young about 70 mm. in length taken from a nest, all black in colour.

A comparison of both skins and skulls of these specimens, which agree very well with Dr. E. P. Ramsay's description, with those of *M. rattus*, Linn., shows that *M. tompsoni* is a synonym of the latter, a conclusion borne out by the similar habits of the two species.

The Wagga Wagga rats are found about grocers' stores and in stables; a nest containing five young, which was dislodged in a stable, was arranged in a scooped-out hole under the brick flooring, having walls of straw and leaves, followed by a layer of fine shredded bark, and an inner lining of wool, feathers and down.

Mr. K. H. Bennett gave an account<sup>1</sup> of the migrations of this species in the western portion of New South Wales, from which it would appear that it swarmed into this State from Western Queensland and was at the time spreading southwards and eastwards. Examples are in the Australian Museum collection from Queensland, New South Wales, and Tasmania (*M. variabilis*, H. and P.).

---

<sup>1</sup> Bennett—Proc. Linn. Soc. N. S. Wales, (2), ii., 1886, p. 447.

## TWO NEW SPECIES OF COLLEMBOLA.

By W. J. RAINBOW, F.L.S., F.E.S., Entomologist.

(Figs. 49-52).

There has recently been added to the Entomological collection of the Museum, two species of Aquatic Collembola, representing two distinct genera—*Isotoma*, Bourlet, and *Achorutes*, Templeton. Of these, which are apparently undescribed, the first was collected by Professor T. W. E. David, B.A., one of the Trustees of the Museum, at the Yarrangobilly Caves, and the other by my friend Mr. S. J. Johnston, B.Sc., from a pond at Bathurst.

In respect of the first which I name, *Isotoma troglodytica*, my colleague, Mr. C. Hedley, hands me the following interesting observations:—

“Deep in one of the western Yarrangobilly Caves flows a subterranean brook, in a pool of which and on wet stones around it the guide pointed out to Messrs. Hamlet, Andrews and self, the *Isotoma*. It occurred in large numbers but seemed confined to one locality. Its movements were sluggish, and so far as we could see, the brilliant magnesium-wire light carried by the guide, produced no effect upon it.

So curious an animal of course appealed to my collecting appetite, but proceeding to gather some, the caretaker reminded me of the wholesome regulation that no specimens are to be removed from the cave reserves except by permission of the Department. A few months later Prof. David visited the caves and as the Department would probably relax their rule in his favour, I handed to him a tube of alcohol and commended the subterranean ‘insects’ to his favourable attention. How kindly he fulfilled this mission Mr. Rainbow’s paper will tell.”

Family DEGEERIADÆ.

Genus ISOTOMA, Bourlet.

ISOTOMA TROGLODYTICA, sp. nov.

(Figs. 49, 50).

Length, 1.2 mm. Colour, creamy white. *Head*.—Clothed with a few fine short hairs. *Antennæ*.—Short; less than length of head. *Post-Antennal Organ*.—Oval. *Ocelli*.—Eight on each

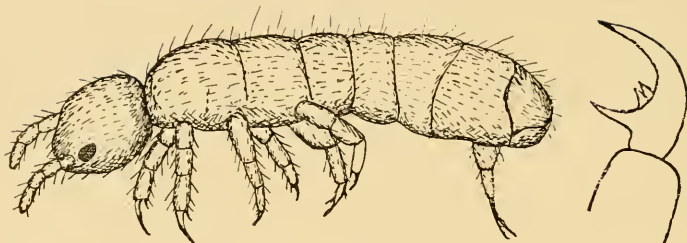

Fig. 49. *I. troglodytica*, Rainb. Fig. 50. *I. troglodytica* (mucro) Rainb.

side of head; these are seated upon dark patches. *Body*.—Elongate, sparingly clothed with short, fine hairs. *Spring*.—Short, not reaching to ventral sucker; *mucro*, toothed (fig. 50). *Legs*.—Short, strong, pilose; *tarsi*, without tenant hairs, claws long.

*Hab*.—Yarrangobilly Caves, on the surface of shallow cave pools.

#### Family PODURIDÆ.

*Genus* ACHORUTES, *Templeton*.

ACHORUTES SPECIOSUS, *sp. nov.*

(Figs. 51, 52).

Length 0·8 mm. Colour, in some examples bluish-grey above, reddish-grey ventrally; others wholly bluish-grey, but of a somewhat lighter tint underneath. *Head*.—Large, sub-triangular, truncate anteriorly, clothed with fine short hairs. *Antennæ*.—



Fig. 51. *A. speciosus*, Rainb. Fig. 52. *A. speciosus* (tarsus), Rainb.

Short, four-jointed. *Ocelli*.—Eight on each side; seated upon black patches; remote from base of antennæ. *Body*.—Cylindrical: segments sub-equal, and clothed with very short, fine hairs; apex of abdomen terminating obtusely. *Spring*.—Short, not reaching to ventral sucker. *Legs*.—Short, strong, clothed like the body; *tarsi* biungulate, the lesser claw minute (fig. 52).

*Hab*.—Bathurst; from the surface of a pond.



## OCCASIONAL NOTES

---

### V.—THE GENERIC NAME *CREPIDOGASTER*.

In consequence of removal from Sydney I was unable to see proofs of my paper "Descriptions of and Notes on some Australian and Tasmanian Fishes," published in the preceding number of the "Records."<sup>1</sup> In writing, I had overlooked the fact that the name *Crepidogaster* is not available in Fishes.

On page 201, I followed Günther in using *Crepidogaster* for a genus in Gobiesocidæ, but this name, applied to fishes in 1861, was previously used by Boheman (1848),<sup>2</sup> for a genus of Coleopterous insects.

I therefore propose the name *ASPASMOGASTER* as a substitute for *Crepidogaster* in Fishes.

EDGAR R. WAITE.

Canterbury Museum,  
Christchurch, N.Z.  
19th July, 1906.

### VI.—NOTE ON AN UNUSUAL SET OF STONE PLOVER'S EGGS.

The Curator handed me for examination, from Mr. Norman Etheridge's collection, a remarkable set of eggs of the Stone-Plover (*Edicnemus gallarius*, Lath.). It comprises for this species the unusual number of four eggs. They were fresh, and all found together in a scantily grass-lined depression in the earth at Bargo by Mr. G. Hambridge, on the 20th September, 1906. Presumably it is the result of two females laying in the same nest for the eggs are of two fairly distinct types varying in the inten-

---

<sup>1</sup> Waite—Rec. Austr. Mus., vi., 3, 1906, pp. 194 and 201.

<sup>2</sup> Boheman—Ins. Caffr., i., 1848, p. 68, *vide* Gemminger and Harold.

sity of their markings, also in size. One pair is oval in form, with the stone ground-colour almost uniformly freckled, spotted and blotched with dull olive-brown. Length (A) 2.22 x 1.6 inches; (B) 2.3 x 1.57 inches. Of the other pair one is inclined to rounded-oval, the other oval slightly compressed at the smaller end. The markings on the stone ground-colour of this pair are distinctly larger and darker, varying from a dark olive-brown to a dark brown, with which are intermingled a few underlying irregular shaped spots, and small blotches of dull inky-grey; the markings being evenly distributed over the surface of the shell, except on the larger end of one specimen, where they coalesce and form a well-defined cap. Length (C) 2.33 x 1.64 inches, (D) 2.38 x 1.7 inches.

ALFRED J. NORTH.





# RECORDS

OF THE

LIBRARY  
AUSTRALIAN MUSEUM.  
GALLERY

EDITED BY THE CURATOR.

---

Vol. VI., No. 5.

---

PRINTED BY ORDER OF THE TRUSTEES.

R. ETHERIDGE, JUNR., J.P.,

Curator.

SYDNEY, 18th JULY, 1907.

## CONTENTS.

	PAGE.
Lower Cretaceous Fossils from the Sources of the Barcoo, Ward and Nive Rivers, South Central Queensland. By R. Etheridge, Junr., Curator...	317
Notes on the Architecture of Australian Araneidæ. Part 6, Entelegyne. By W. J. Rainbow, F.L.S., F.E.S., Entomologist	330
Additions to the Avi-Fauna of the County of Cumberland. By Alfred J. North, C.M.Z.S., Ornithologist	339
The Results of Deep-Sea Investigation in the Tasman Sea. II. The Expedition of the "Woy Woy."	
1. Fishes and Crustaceans from Eight Hundred Fathoms. By Allan R. McCulloch, Zoologist	345
2. Mollusca from Eight Hundred Fathoms, Thirty-five Miles East of Sydney. By Charles Hedley.	356
North Queensland Ethnography. Bulletin No. 9. Burial Ceremonies and Disposal of the Dead. By Walter E. Roth, Magistrate of the Pomeroon District, British Guiana, etc.	365
Mineralogical Notes: No. v.—Cassiterite, Cerussite, Zeolites and other Australian Minerals. By C. Anderson, M.A., B.S., Mineralogist	404
Occasional Notes—	
VII.—Eggs of <i>Cacomantis insperatus</i> , Gould. By A. J. North...	423

LOWER CRETACEOUS FOSSILS FROM THE SOURCES OF  
THE BARCOO, WARD AND NIYE RIVERS, SOUTH  
CENTRAL QUEENSLAND.

PART I.—ANNELIDA, PELECYPODA AND  
GASTEROPODA.

By. R. ETHERIDGE, JUNR., Curator.

(Plates lvii.-lxii.).

CORRECTIONS.

Page 256, footnote—for “portion” read “position.”

Plates xlii., xliii., xlv., at foot of plate—for “H. Barnes, Junr.”  
read “T. Whitelegge.”

Plate liii.—substitute the plate inserted in this part (5) for that  
previously issued (in part 4), on which the figure numbers  
were omitted.

Page 404, line 18—for “the faint line” read “a line.”

ends, but in one instance one of the ends is more acute than the  
other. The surface is roughened with faint irregular transverse

---

<sup>1</sup> Etheridge—Aust. Mus. Rec., v., 2, 1904, p. 114, pl. xiv., f. 1-3.

YRABULL  
M. Q. 110, 110, 110, 110  
M. Q. 110, 110, 110, 110  
CONTENTS.

	PAGE.
Lower Cretaceous Fossils from the Sources of the Barcoo, Ward and Nive Rivers, South Central Queensland. By R. Etheridge, Junr., Curator... ..	317
Notes on the Architecture of Australian Araneida. Part 6, Entelegyne. By W. J. Rainbow, F.L.S., F.E.S., Entomologist ...	330



LOWER CRETACEOUS FOSSILS FROM THE SOURCES OF  
THE BARCOO, WARD AND NIYE RIVERS, SOUTH  
CENTRAL QUEENSLAND.

PART I.—ANNELIDA, PELECYPODA AND  
GASTEROPODA.

By. R. ETHERIDGE, JUNR., Curator.

(Plates lvii.-lxii.).

1.—INTRODUCTION.

The Trustees have acquired from time to time during the last few years, and through the liberality of Mr. H. W. Blomfield, a large suite of Queensland Cretaceous Fossils in various states of preservation. Many of these are well known forms, others species only partially described, and a few apparently new.

The whole series is representative of the Lower Cretaceous or "Rolling Downs Formation," and is from an area drained by head waters of the Barcoo, Ward, and Nive Rivers, source affluents of the Warrego River, itself a branch of the great Darling; unfortunately more precise localities were not recorded.

2.—DESCRIPTION OF THE FOSSILS.

COPROLITES.

(Plate lx., figs. 4 and 5).

*Obs.*—I have already referred<sup>1</sup> to certain bodies from the Point Charles Cretaceous deposit as probably coprolitic. In the present collection are two objects possessing the appearance of coprolites and very much larger than those from Point Charles. One of these is three inches long, and three quarters of an inch in transverse diameter. Both are fusiform in outline, tapering at both ends, but in one instance one of the ends is more acute than the other. The surface is roughened with faint irregular transverse

---

<sup>1</sup> Etheridge—Aust. Mus. Rec., v., 2, 1904, p. 114, pl. xiv., f. 1-3.

constrictions, but the tapering extremities are spiral as in ordinary Ichthyosaurian coprolites. Both of the specimens are convex on one side and faintly concave on the other.

A section prepared for the microscope from the fractured end of the incomplete specimen does not afford much information. The ground mass is limonitic with scattered quartz grains, but there are no fish scales or other minor exuviae.

## ANNELIDA.

*Genus* SPIRULÆA, *Bronn*, 1827.

(*Jahrb. Min.*, 1827, ii., p. 544).<sup>2</sup>

*Obs.*—Zittel tells<sup>3</sup> us that Bronn selected the involute and free species *Serpula spirulæa*, Lamk., as the type of his genus *Spirulæa*. In the same year (1827), DeFrance proposed<sup>4</sup> the name *Rotularia* for this and other species, including both free and attached Tubicolar Annelids. As it is very convenient to accept even this artificial division of the genus *Serpula*, I adopt Bronn's term for those free involute species such as *S. spirulæa*. Tubes of this nature are met with in Oolitic, Cretaceous, and Tertiary strata.

SPIRULÆA GREGARIA, *sp. nov.*

(Plate lvii. ; Pl. lx., figs. 1-3).

*Sp. Char.*—Shell involute, concavo-sub-convex, from 5-15 millimetres in diameter, consisting of three or four whorls, terminating in a free tube of variable length; on the concave aspect the whorls are telescopic, and individually rounded, but on the sub-convex aspect each whorl is sloping and moreover less faintly convex. Periphery convex, neither ridged nor angled, section of tube round; sculpture fine and concentric, the free tube in some cases corrugated.

*Obs.*—A hand specimen of calcareous shale is crowded on both weathered surfaces with these involute tubes, in fact they chiefly compose the rock, associated with a few small Belemnites. The form is closely allied to *S. concava*, J. Sby.,<sup>5</sup> from the Upper Greensand of the South of England. In some respects it also resembles *S. bognoensis*, Mantel,<sup>6</sup> a Tertiary species, but

<sup>2</sup> *Fide* Bronn—*Index Pal.*, *Nomen.*, 1848, p. 1139.

<sup>3</sup> Zittel—*Handb.*, *Pal.*, 1 *Abth.*, i., 3, 1880, p. 564.

<sup>4</sup> DeFrance—*Dict. Sci. Nat.*, xlvi., 1827, p. 321.

<sup>5</sup> Sowerby—*Min. Con.*, i., 1814, p. 125, pl. lvii., f. 1-5.

<sup>6</sup> Sowerby—*Min. Con.* vi., 1828, p. 294, pl. dxvii., f. 1-3

possesses a less number of whorls and a more telescopic concave aspect.

### PELECYPODA.

Genus PSEUDAVICULA, *Eth. fil.*, 1892.

(*Geol. Pal. Q'land, &c.*, 1892, p. 449).

*Obs.*—In my original description, lacking evidence to the contrary, I accepted Moore's statement<sup>7</sup> that the type species (*Lucina anomala*, Moore) was equivalve. I have now material to show that the shell, I have for years rightly or wrongly named *Pseudavicula anomala*, Moore, sp., is decidedly inequivalve. The left valve is the more convex, the umbo higher than in the right, and slightly overhanging the cardinal margin, the umbo of the right valve is depressed and does not project above the cardinal margin. Later acquired specimens of *P. australis*, Moore, sp., lead to the belief that such is also the case in that species, as it certainly is in the one to follow.

#### PSEUDAVICULA PAPYRACEA, *sp. nov.*

*Undetermined Bivalve*, *Eth. fil.*, *Geol. Pal. Q'land, &c.*, 1892, p. 482, pl. xxi., f. 14.

*Sp. Char.*—Shell suborbicular, delicate and fragile, compressed, posteriorly alate, test very thin, papyraceous. Left valve convex in the umbonal region, with a sharply-pointed rather elevated umbo. Right valve more depressed than the left and the umbo inconspicuous. Dorsal margins on both sides straight, those anterior to the umbo obliquely inclined, those on the posterior straight; anterior ends small, the margins rounded; posterior alations small, flat, the margins rectangular. Sculpture of microscopic concentric lines.

*Obs.*—This very delicate shell, or fragments of it, occurs throughout the *Pachydomella* calcareous mudstone, of which so much of the collection is made up, in large numbers in association with the still more common *Pachydomella chutus*. In not a single instance have I seen the test complete in any one specimen, the usual conditions being that of internal casts, or the latter with fragments of test adhering, which must have been very thin and fragile.

---

<sup>7</sup> Moore—*Quart. Journ. Geol. Soc.*, xxvi., 1870, p. 251.

The outline is that of my conception<sup>8</sup> of *Pseudavicula anomala* Moore, sp., but out of the immense number of specimens and fragments not one has shown the characteristic sculpture of that species. Indeed, the only trace of ornament on the shell of *P. papyracea* is that of a few concentric, almost microscopic lines; the test is far too thin to carry the well marked decussate sculpture of *P. anomala*.

I believe it to be one of the undetermined valves figured at the reference above.

The specific name is in allusion to the delicate nature of the test. Figures will be given in a subsequent part.

*Genus* MACCOYELLA, *Eth. fil.*, 1892.

(*Geol. Pal. Q'land, &c.*, 1892, p. 451).

MACCOYELLA CORBIENSIS, *Moore, sp.*

(Plate lxi, figs. 1-6).

*Avicula corbiensis*, Moore, *Quart. Journ. Geol. Soc.*, 1870, xxvi, p. 246, pl. xi, f. 7.

*Maccoyella corbiensis*, *Eth. fil.*, *Mem. Geol. Survey N. S. Wales*, Pal. No. 11, 1902, p. 21, pl. i, f. 6-10 (*for synonymy*).

*Obs.*—In the phenomenally rich calcereous shale containing the preceding species and *Pachydomella chutus* occur a large number of left valves agreeing in every particular with the corresponding valve of *M. corbiensis*, except in that of size. The maximum measurements of this species are approximately two and a quarter inches in length by two and a half inches in breadth, whereas in the specimens under review the average is about one half of the above; other than by this discrepancy, I am unable to differentiate between the respective specimens. In other words, those collected by Mr. Blomfield are *M. corbiensis* in miniature, and seem to represent a dwarf race of the species. Here and there, it is true, are examples with a greater breadth in proportion to length than in *M. corbiensis* proper, but this cannot be allowed to weigh in the face of more important features. Again, the posterior alation seems to be more highly developed in some examples than in larger individuals from other localities. One specimen fortunately, although worn externally, has the internal structure admirably preserved, particularly that of the articulus (Pl. lxi, fig. 1).

---

<sup>8</sup> Etheridge—*Mem. R. Soc. S. Austr.*, ii, 1, 1902, pl. ii, f. 1.

An interesting point occurs in connection with the relation of these shells to *Orytoma rockwoodensis*, mihi.<sup>9</sup> The shorter and broader examples closely resemble this, but the costæ in the latter are so much less in number. Before relegating *O. rockwoodensis* to the position of a synonym of *M. corbiensis* it will be necessary to see the interior of the former; should the two articuli agree, and my assumption that the present fossils are a dwarf race of the latter, it will be useful to distinguish them by using the name of the first in a varietal sense for the present fossils.

*Genus AUCELLA, Keyserling, 1846.*

(Reise in das Petschora Land, 1846, p. 297).

AUCELLA HUGHENDENENSIS, *Etheridge.*

(Plate lviii.; Pl. lxi., figs. 7-12).

*Avicula hughendenensis*, Etheridge, Quart. Journ. Geol. Soc., xxviii., 1872, p. 346, pl. xxv., f. 3.

*Aucella hughendenensis*, Eth. fil., Mem. R. Soc. S. Austr., ii., 1, 1902, p. 14 (*for synonymy*).

*Obs.*—Foremost amongst the specimens of this collection is a very beautiful weathered example of this species, by far the finest group I have seen. Although the shell is now well known, other and smaller specimens reveal some points of structure not hitherto noticed.

The group (Pl. lviii.) displays to great perfection both valves, some in apposition. Amongst other notable points are the size attained, gradual fading away of the delicate costæ on the left valve from the umbonal region downwards, and the oblique fan-like outline of the right valve.

From the smaller specimens already referred to we learn that the small triangular auricle of the right valve was in some cases received (Pl. lxi., fig. 10) in an anterior inflection of the cardinal margin of the right valve. Another specimen displays the central and posterior portions of the cardinal margin of the left valve (Pl. lxi., fig. 11) as a broad sub-triangular concave area, but without a chondrophore; the cardinal margin of the right valve posterior to the umbo is thickened, but without forming a defined area. Another very interesting fact in the right valve is the delicate

---

<sup>9</sup> Etheridge—Geol. Pal. Q'land, &c., 1892, p. 448, pl. xxiv., f. 15.

crenulation of the lower margin of the auricle, and the concave dorsal margin of the valve opposite to it (Pl. lxi., fig. 7); this crenulation arises from a rugosity of the concentric laminae of the surface at those particular points.

On comparing the articulus of *A. hughendenensis* with that of *Maccoyella* we notice the absence of a chondrophoral button in the right valve, nor so far as I know, has the blunt tooth said to exist in the right valve of *Aucella* been seen in an Australian specimen.

*Genus* MODIOLA, Lamarck, 1799.

(Mém. Soc. Hist. Nat. Paris, 1799, p. 89).

MODIOLA DUNLOPENSIS, *Eth. fil.*

(Plate lx., fig. 6).

*Modiola dunlopensis*, *Eth. fil.*, Mem. Geol. Survey N. S. Wales, Pal. 11, 1902, p. 23, pl. v., f. 4 and 5, pl. vi., f. 1 and 2, pl. vii., f. 1.

*Obs.*—A single specimen is present, rather more than the posterior third of the conjoined valves. It is the first occurrence of the species in Queensland known to me.

*Genus* TRIGONIA, Bruguière, 1789.

(Encycl. Method., i., 1789, pl. xiv.).

TRIGONIA CINCTUTA, *Eth. fil.*

(Plate lx., fig. 9).

*Trigonia cinctuta*, *Eth. fil.*, Mem. Roy. Soc. S. Australia, ii., pt. 1., 1902, p. 28, pl. iv., f. 4-6, (?) 7.

*Obs.*—This is represented by an external impression of the antero-posterior two thirds of the united valves. The fluctuating costae are well shown with large nodes along the margins of the cinctures; the latter are broad. This is the first occasion on which *C. cinctuta* has been met with outside the Lower Cretaceous of South Australia.

*Genus* GRAMMATODON, Meek and Worthen, 1858.

(Proc. Acad. Nat. Sci. Philad., 1858, p. 419).

GRAMMATODON (?) DAINTREEI, *sp. nov.*

(Plate lx., figs. 7 and 8).

*Sp. Char.*—Shell longitudinally oblong, equivalve. Valves tumid, particularly in the umbonal regions which are traversed

by faint, posteriorly-directed cinctures, and separated from the remainder of the posterior ends by curved, rounded, but at the same time prominent diagonal ridges. Cardinal margins wide, but hardly as wide as the valves; umbos tumid, depressed, and faintly prosogyrate, quite anterior but not terminal; area long and narrow, with straight ligamental furrows; hinge plate narrow, with four and perhaps five short, oblique, inwardly directed anterior denticles, and five long upwardly and outwardly directed posterior denticles, the whole of them transversely striate. Adductor scars faint. Ventral margins gently rounded. Anterior ends short, steep, the margins well rounded but not oblique; posterior ends forming quite two-thirds of the valves, at first tumid, but beyond the diagonal ridges flattened and alate, the margins obliquely truncate above, and rounded below. Sculpture of concentric lines at irregular distances apart and of varying strength, crossed by fine radiating costæ, alternately larger and smaller producing an ill-defined cancellation; the costæ in and around the cincture are stronger than the remainder.

*Obs.*—I employ the name *Grammatodon* as originally intended by Messrs. Meek and Worthen, and as distinct from their *Parallelodon*.<sup>10</sup> At the same time I do not feel entirely satisfied that the present shell is a *Grammatodon* in consequence of the oblique posterior teeth rather than the latter parallel to the cardinal margins, and also from the fact that all the denticles are transversely striate. In the possession of this striation it resembles a Cretaceous genus of Conrad's *Polyneina*.

In some respects *G. (?) daintreei* resembles a previously described *Barbatia*-like *Arc*—*Uucullara hendersoni*, mihi,<sup>11</sup> from the Lower Cretaceous of the Tambo District, Queensland, which, I regret, I am unable to compare with it. In the species mentioned the umbos are so much more central, and without umbonal cinctures that I think the two shells can hardly be identical.

*G. (?) daintreei* is associated with *Aucella hughendenensis*. Named in honour of the late Richard Daintree, C.M.G., a former Government Geologist of and Agent-General for Queensland.

<sup>10</sup> *Parallelodon*, M. and W. = *Macrodon*, Lycett (*non* Muller), *Macrodon*, Beushausen, and *Beushausenia*, Cossman.

<sup>11</sup> Etheridge—*Geol. Pal. Q'land*, etc., 1892, p. 468, pl. xxvi., f. 2 and 3.

*Genus* CORBULA (*Bruguière*), *Lamarck*, 1801.

(*Syst. Anim. s. Vert.*, 1801, p. 137).

CORBULA SUPER-CONCHA, *sp. nov.*

*Sp. Char.*—Shell inequilaterally subdeltoid, tumid, with well-marked posterior production; slightly inequivalve. Valves very tumid and projecting in the umbonal regions, with large and highly pronounced epiostraca<sup>12</sup>; articulus unknown; cardinal margins strongly triangular, but without a defined escutcheon; umbos prosogyrate. Anterior ends of less width than the posterior, the margins broadly rounded; anterior slope nearly straight walled. Posterior ends moderately produced, nasute but not rostrate or truncate; posterior slope pronounced, flattened, or even a little concave, bounded by a curved diagonal ridge. Ventral margins on the anterior sides obtusely rounded, on the posterior curved obliquely upwards. Sculpture concentric and fine, both valves similar.

*Obs.*—Nothing approaching this well-marked shell has been so far as I can ascertain, described from our Cretaceous rocks. It is referred to *Corbula* purely on outward characters.

One of the most marked features is the very pronounced umbonal and infra-umbonal epiostracum (as I term it) in both valves, marking growth stages. This is a pronounced feature in many *Corbula*, although not in all, but here these stages are important and appear to be almost a specific character. The depth to which the first stage extends is variable, but not infrequently occupies at least half if not more of the length of a valve. The sculpture is fine and linear, and without concentric corrugations as in some species.

I have failed to find any near ally in Cretaceous rocks, although were *C. traskii*, Gabb<sup>13</sup>, less rostrate, it would not be unlike the present shell in outline; a similar remark also applies to *C. buckmani*, Buckman<sup>14</sup>, an Oolitic species.

Figures will be given in a subsequent part.

<sup>12</sup> I employ this term to signify that most marked of growth stages looking like a shell upon a shell.

<sup>13</sup> Gabb—Report Geol. Survey California, i, 4, 1864, p. 149, pl. xxii., f. 121, 121a.

<sup>14</sup> Lycett—Suppl. Mon. Moll. Gt. Oolite, etc., 1863, pl. xxxvii., f. 8.



*Genus PACHYDOMELLA*,<sup>15</sup> *gen. nov.*

*Obs.*—The single species comprised in this genus, although diminutive, is a most important one geologically. Within the area from which Mr. Bloomfield's collection was made, it evidently marks a well defined horizon, and occurs in countless numbers. Had it not been for this, I would not have ventured to describe it from the very simple fact that I am unable to give any definite generic characters except the edentulous condition. The slab figured on Pl. lix., will afford some idea of the enormous numbers in which this little shell occurs. Furthermore, its external characters are such that it can be easily recognized in the field, and this with its highly gregarious nature will always afford aid to the field geologist.

Notwithstanding its plentitude and in a comparative sense its thick test, I have been unable to observe either the adductor scars or pallial line; for all I can see to the contrary the latter is entire. Under these circumstances the following description must serve both as a generic and specific definition. The name must be regarded for the present, simply as one of convenience.

PACHYDOMELLA CIUTUS<sup>16</sup>, *sp. nov.*

(Plate lxii., figs. 4-8)

*Sp. Char.*—Shell small, transversely ovate, trigonal, very slightly inequilateral; test thick. Valves convex, the convexity increased by one or more epiostraca, the umbonal one usually large and projecting, when more than one on each valve, they overlap from above downwards. Cardinal margins slightly angular; neither lunule nor escutcheon; articulus edentulous; umbos prosogyrate, small. Anterior ends slightly less than the posterior, the margins of the former rounded, those of the latter more obtuse; posterior slope present, but ill defined. Ventral margins widely semi-circular. Sculpture concentric and delicate.

*Obs.*—I am not able to suggest even an alliance for this gregarious mollusc. The name *Pachydomella* is not to be taken as thereby indicating a relation to the Permo-Carboniferous genus *Pachydomus*, it is given simply in allusion to the thick test and small size, and the specific name similarly refers to the prominent overlapping epiostraca, that form so marked a feature on each

<sup>15</sup> πᾶχυς—thick, δόμος—house.<sup>16</sup> χυτός—heaped up.

valve. At first sight the general appearance reminds one of the *Corbula* group, but any alliance therewith is at once discounted by the edentulous nature of the articulus.

I have examined a large number of internal casts, but only with negative results; all the internal features of the test must have been very weak.

In view of future research, I would like to point out that Moore described a small bivalve as *Maetra trigonalis*<sup>17</sup>, and said a thin slab from the Nive River Downs "appears to be almost composed of this little shell." Moore's figure was drawn from a very poor specimen, that is certain. It is equally clear the figure in question, as it stands, does not represent the present species. At the same time allowing for Moore's very brief descriptions of his Australian shells, and the often imperfect material figured, there is the possibility, both being gregarious, that *M. trigonalis* and *C. chutus* are one and the same; on the other hand the test of the latter is not thin, and supposing them to ultimately prove identical, they are not a *Maetra*.

Genus CYTHEREA, Lamark, 1806.

(Ann. Mus. Hist. Nat. Paris, 1806, vii., p. 132).

CYTHEREA (?) MOOREI, Eth. fil.

(Plate lxii., figs. 1-3).

*Cyprina* (?) sp., Hudleston, Geol. Mag., i., 1884, p. 341, pl. xi., f. 7a and b.

*Cytherea* (*Cyprina*?) *Moorei*, Eth. fil., Geol. Pal. Q'land, etc., 1892, p. 474, pl. xxxiv., f. 12 and 13.

*Sp. Char.*—Shell ovate, width and length nearly equal, inequality of the sides well marked. Valves tumid in the umbonal regions frequently through the presence of well marked epiostraca; compressed ventrally. Cardinal margins sharply angular; lunule widely diamond or lozenge-shaped; escutcheon undefined. Anterior and posterior ends very unequal, the latter much the larger, occupying at least two-thirds of the shell width, and slightly obtusely produced; anterior and ventral margins are well and regularly rounded, but the posterior is more sharply rounded than the anterior. Sculpture concentric, of very regular grooves with flat interspaces.

---

<sup>17</sup> Moore—Quart. Journ. Geol. Soc., xxvi., 1870, p. 252, pl. xiv., f. 6.

*Obs.*—The imperfect shell figured by Mr. Hudleston from South Australia, and to which I applied the name of *Cytherea moorei* is the only described bivalve with any relation to the present form. There are numerous specimens in the collection, smaller certainly than that represented by Hudleston's figure, but not otherwise sufficiently differentiated to warrant separation.

I know not what to make of *Astarte wollumbillaensis*, Moore,<sup>18</sup> the figure portrays so imperfect a specimen, but the sculpture is certainly like that of the present fossils.

#### GASTEROPODA.

*Genus* CANCELLARIA, Lamarck, 1799.

(Mèm. Soc. Hist. Nat. Paris, 1799).

CANCELLARIA (?) TERRAREGINENSIS, *sp. nov.*

(Plate lx., fig. 11).

*Sp. Char.*—Shell small, ventricose-turbinate, whorls four, sharply differentiated from one another in size, and all more or less shoulder-like around the sutures. Body whorl ventricose, greatly exceeding the penultimate whorl in size, and rendered [quinqu]-angular by several [five] transverse keels, crossed by prominent equidistant costæ extending from the suture across the two first keels only, or perhaps nearly as far as the third; antepenultimate whorl with certainly three and perhaps four keels.

*Obs.*—The mouth is unknown to me and the tentative reference to *Cancellaria* is based only on form and sculpture.

I have already described<sup>19</sup> the body whorl of a univalve (*Delphinula* (?) *sturti*) from the Lower Cretaceous of South Australia with distant spiral keels, but without longitudinal costæ forming a kind of coronation; the actual relation of the two has yet to be shown.

*Genus* VANIKOROPSIS, Meek, 1876.

(Report U.S. Geol. Survey Territories (Hayden's), ix., 1876, p. 351).

VANIKOROPSIS (?) STUARTI, *Eth. fil*

(Plate lxii., figs. 9-13).

*Vanikoropsis* (?) *Stuarti*, *Eth. fil.*, Mem. R. Soc. S. Austr., ii, 1, 1902, p. 42, pl. vi., f. 18-20.

<sup>18</sup> Moore—Quart. Journ. Geol. Soc., xxvi., 1870, p. 250, pl. xii., f. 12.

<sup>19</sup> Etheridge—Mem. R. Soc. S. Austr., ii., 1, 1902, p. 41, pl. vi., f. 21 and 22.

*Sp. Char.*—Shell more or less naticiform, sub-globose; spire slightly elevated; test thick. Whorls four, the posterior globose and straight walled; sutures channeled; body whorl much exceeding the others in size, inflated, convex above; inner lip reflected and slightly channeled or grooved. Sculpture when unworn of spiral, equidistant slightly wavy ridges separated by wider valleys, and the whole crossed by a variable number of oblique costæ, which on the posterior whorls pass from suture to suture, but on the body whorl are confined to the posterior convex surface only; the points of intersection are minutely nodose, whilst the crossing of these two systems of ridges converts the valleys into a series of small quadrangular spaces. When weathered the minute nodes become worn off leaving small depressions, and these, added to the already mentioned quadrangular spaces give to this superinduced sculpture, a highly ornate appearance.

*Obs.*—This little naticiform shell is by no means uncommon in the Pachydomella calcareous mudstone, although this is, to me, its first occurrence in the northern extension of our Lower Cretaceous.

The costæ appear to be very variable in number, indeed one specimen is provided with so few as to almost separate it from the remainder. When completely divested of the sculpture layers and the mouth imperfect, it is almost impossible to distinguish *V. (?) stuarti* from *Pseudanaura variabilis*, Moore, sp.<sup>20</sup>

*Genus* ANISOMYON, *Meek and Hayden*, 1860.

(*Am. Journ. Sci.*, (2), xxix., 1860, p. 35).

ANISOMYON (?) *DEPRESSUS*, *sp. nov.*

(Plate lx., figs. 13 and 14).

*Sp. Char.*—Shell ovate-elliptical, patelliform, depressed, the ends not equally broad; lateral margins sub-parallel, converging slightly towards the posterior (?); apex depressed, obtuse, nearly central; both anterior and posterior slopes convex, the former (?) the more abrupt.

*Obs.*—I take the present opportunity of figuring a shell not comprised in the Blomfield collection, because although in a poor condition it entirely differs from both the Patelliform shells previously described. The name *Anisomyon* is applied to it solely

---

<sup>20</sup> Etheridge—*Mem. Geol. Survey N.S.Wales*, Pal. No. 11, 1902, p. 40.

from its resemblance to some of the American species so referred by Meek and Hayden, particularly *A. subovatus*, M. and H.,<sup>21</sup> as I have not seen the peculiar muscle scar typical of the genus.

The specimen is much exfoliated hence the sculpture is unknown, but there is no trace of radii as in *Siphonaria samwelli*, Eth. fil.<sup>22</sup> It may be distinguished from the shell termed *Acmea* (?) *monswoodensis*<sup>23</sup> by me, to which it is much more nearly allied by the outline and relative size of its parts.

*Loc.*—Three miles north-west of Kensington Downs Homestead, Kensington Downs, near Longreach, Queensland (*A. J. Ewen*).

*Genus* ODONTOSTOMIA, *Fleming*, 1828.

(*Hist. Brit. Animals*, 1828, p. 310).

ODONTOSTOMIA (?) CRETACEA, *sp. nov.*

(Plate lx, figs. 10, 10a).

*Sp. Char.*—Shell robust-conoid, spire short. Whorls three and a heterostrophic apex; body whorl inclined to be globose, the outline rounded; penultimate and antipenultimate whorls almost straight walled; heterostrophic apex globose, apparently of more than one whorl, lying at right angles to the axis of the adult shell in which it is slightly immersed. Sculpture of delicate revolving lines crossed by equally fine straight transverse lines or costæ producing a fine cancellation.

*Obs.*—This is referred to *Odontostomia* with reservation as the mouth has not been seen, but the distinct heterostrophic apex clearly points to this genus or one of its close allies. The group of Mollusca to which this shell belongs appears to be little known in the Cretaceous; Stoliczka has described one species but it is quite distinct from *O. (?) cretacea*.

<sup>21</sup> Meek and Hayden—Report U. S. Geol. Survey Territories (Hayden's), ix., 1876, p. 291, pl. xviii., f. 5d and 6.

<sup>22</sup> Etheridge—Geol. Pal. Q'land, etc., 1892, p. 573, pl. xlii., f. 9.

<sup>23</sup> Etheridge—Rec. Austr. Mus., v., 4, 1904, p. 251, pl. xxvii., f. 5-7.

NOTES ON THE ARCHITECTURE, NESTING HABITS, AND  
LIFE HISTORIES OF AUSTRALIAN ARANEIDÆ, BASED  
ON SPECIMENS IN THE AUSTRALIAN MUSEUM.

By W. J. RAINBOW, F.L.S., F.E.S., Entomologist.

(Figs. 53-54).

PART VI.—**ENTELEGYNÆ** (*Continued*).

*Family* ARGIOPIDÆ (=EPEIRIDÆ, *Auct.*).

Formerly this family was considered as including all and only those species whose snares are geometrical or orbicular. Dr. McCook in his great work<sup>1</sup> adopted this method. Since, however, some species, which cannot under any consideration be regarded as Argiopidæ, fabricate orbicular webs<sup>2</sup>, and some true Argiopids do not, any classification which has for its basic principal the method or style of architecture, must of necessity be artificial and unscientific. This doubtful system of classification, of course, is not by any means new; it was used by the old school of naturalists, and so far as McCook is concerned, is interesting only from the fact that so modern and capable a student still apparently adheres to and even justifies it.

The family is extensive and widely spread, and the species comprising it sedentary. Simon has divided it into four sub-families, viz., Linyphiinæ, Tetragnathinæ, Nephilinæ, and Argiopinæ, and these latter again into numerous groups or sections.

*Sub-family*, LINYPHIINÆ.

The Linyphiinæ are regarded by some authors as entitled to absolute family rank—Linyphiidæ, but Simon has included them in the Argiopidæ as a sub-family. In doing so, the author quoted, points out that though it is possible to trace a number of constant

---

<sup>1</sup> McCook—*American Spiders and their Spinning Work*, i., 1889, p. 17.

<sup>2</sup> Rainbow—*Rec. Aust. Mus.*, iv., 3, 1901, p. 138.

characters that separate *Theridion* from *Linyphia*, it is not so easy to separate the latter from *Araneus*; the single feature relied upon by authors to distinguish the two latter, namely, the greater or lesser width of the clypeus being of little value and not even constant. On the other hand there exists between *Linyphia* and *Araneus* all possible passages, in which respect the sub-family Tetragnathinæ is particularly interesting<sup>3</sup>.

Linyphiinæ are divided into three natural groups: Erigoneæ, Formicineæ and Linyphiæ, and of these the first and third occur in Australia. The second includes two genera, namely, *Formicina*, Canest., and *Solenysa*, Sim. The former is apparently restricted to the Mediterranean region, and the latter Japan.

The head-quarters of Erigoneæ are apparently Palaearctica. The group contains upwards of sixty genera, and an immense number of species. Very few are known from Oceania, and only one species, *Neriene analis*, Sim., has so far been described from Australia (Victoria inter.<sup>4</sup>). The geographical range of *Neriene*, Blackw., is "Europa et Reg. mediterr.; Asia sept., centr. et orient; Amer. sept. et merid.; N.-Hollandia et N.-Zealandia."<sup>5</sup>

The Linyphiæ group embraces about twenty-seven genera, some of which are of world-wide distribution. Two only, however, are known to occur in Australasia: *Bathyphantes*, Menge, and *Linyphia*, Latr. Of these the range of the former is "Europa; Reg. mediterr.; Asia sept., centr., orient. et merid.; N.-Hollandia et N.-Zealandia; America sept. et merid. andina,"<sup>6</sup> and of the latter, "Orbis reg. om. frigidæ, temp. et rarius calidæ."<sup>7</sup> *Bathyphantes* is represented by *B. weburdi*; it was described by Urquhart as a species of *Linyphia*<sup>8</sup>, and was based upon a single specimen collected at the Jenolan Caves, N. S. Wales. Four other species, namely, *L. melanozantha*, *L. quindecim-punctata*, *L. sublutea*, and *L. nitens*, have been described by the same author from Tasmania.<sup>9</sup>

The webs of our native species have not been noted; nevertheless, wherever the Linyphiinæ have been studied, they have been found to make either a flat or dome-shaped web, supported above, below, and laterally by numerous irregular threads, the spider standing, usually, underneath in some corner out of sight. I once

<sup>3</sup> Simon—Hist. Nat. des Araignées, 2nd ed., i., 1892, p. 593.

<sup>4</sup> Simon—*Loc. cit.*, p. 667.

<sup>5</sup> Simon—*Loc. cit.*, p. 667.

<sup>6</sup> Simon—*Loc. cit.*, p. 705.

<sup>7</sup> Simon—*Loc. cit.*, p. 707.

<sup>8</sup> Urquhart—Trans. N. Z. Inst., xxii., 1889, p. 236, pl. xvi. fig. 2.

<sup>9</sup> Urquhart—Proc. Roy. Soc. Tas., 1892 (1893), pp. 103-108.

saw, at Guildford, among some coarse herbage, a small dome-shaped snare, such as described above, but the architect was not at home. Probably it had fallen as prey to some lizard. The dome of the web was very closely woven. These spiders are very small; they may be found among coarse herbage, under ledges of rocks, among reeds in marshes, and in angles between branches of trees. None of the Linyphiinae construct orbicular snares. An immature *Linyphia*, sp. collected by me was taken with the sweep-net. They do not appear to be very numerous.

#### *Sub-family* TETRAGNATHINÆ.

This sub-family is divided into seven groups, for which Simon proposed the following names: Cyatholipeæ, Pachygnatheæ, Tetragnathææ, Meteæ, Nesticææ, Azilicææ, and Diphyeæ. The third and fourth of these are represented in the Australian fauna.

Seven genera have been assigned to Tetragnatheæ and two of these occur in Australia, namely *Tetragnatha*, Latr., and *Eucta*, Sim.

The genus *Tetragnatha* is very widely distributed, its geographical area being defined as follows: "Orbis totius reg. calid., temp. et frigida."<sup>10</sup> The majority of Australian species occur up north, but two, at any rate, are found in Tasmania: *T. margaritata*, L. K., Port Mackay; *T. ferax*, L. K., Bowen, Port Mackay, and Rockhampton; *T. rubriventris*, Dol. (= *lupata*, L. K.), Port Mackay and Bowen; *T. cylindrica*, Walck. (?), Sydney; *T. conica*, L. K., Bowen, Sydney, and Tasmania; *T. tuberculata*, L. K., Rockhampton, Bowen, Port Mackay, Peak Downs, Brisbane and Sydney; *T. demissa*, L. K., Bowen, Peak Downs, Rockhampton, Gayndah and Sydney; *T. gemmata*, L. K., Port Mackay; *T. valida*, Keys., Peak Downs, Gayndah and Sydney; *T. protensa*, Walck., Rockhampton, The Pelew Islands, and Ovalau, Fiji. *Eucta* is represented in Australia by two species, one apparently peculiar to our mainland, and the other a Malaisian form. They are *E. caudifera*, Keys., Sydney; and *E. anguilla*, Thor., Rockhampton and Malaisia. The range of this genus is: "Europa; Reg. mediterr.; Afr. occid. (*filum*, E. Sim.), India; Japonia (*caudicula*, Karsch); Malaisia (*anguilla*, *javana*, Thorell); Nova-Hollandia (*caudifera*, Keyserl.); Amer. sept. (*vermiformis*, Emert.)"<sup>11</sup>

<sup>10</sup> Simon—Hist. Nat. des Araignées, 2nd ed., i., 1892, p. 724.

<sup>11</sup> Simon—Loc. cit., p. 725.



Among orb-weavers, to which this group of spiders belongs, there are very distinct types, and their webs are equally so. Some of the latter are horizontal or slightly oblique and others perpendicular. The horizontal and oblique orbicular webs are almost invariably the work of species included in this sub family. When a web is oblique, it is due to the nature of its surroundings. Tetragnathid snares are usually constructed over narrow running streams and creeks; hence, in the event of one bank being lower than the other, the natural result would be an oblique web. Although the species appear to prefer the neighbourhood of water, including not only creeks and water-holes, but also swampy areas, they may nevertheless be found at times considerable distances away, so that it is no uncommon experience for the collector to find a Tetragnathid spider and its snare among coarse herbage. When alarmed these spiders will sometimes simply drop from the web, and hang by a thread of silk in mid-air. Thus suspended the creature looks like a bit of stick; at other times they scuttle away from their webs with great rapidity and seek shelter among neighbouring plants and bushes. Upon these they rest, secure from persecution, owing to their colouration. Their long cylindrical bodies, and still longer attenuated legs, add to their protection. A Tetragnathid when concealing itself upon a shrub or coarse grass stretches itself along the stem upon which it has sought refuge. Here, with its body closely adpressed, its first and second pairs of legs stretched well forward, and the third and fourth pairs as carefully directed backwards, it rests in perfect security. When reposing at the centre of the web, the position just described is maintained, with the exception that the legs are not stretched quite so straight, nor are they placed quite so closely together. The webs of Tetragnathinae consist of the usual outer lines and guys which go to make the framework, and which are, of course, attached to plants, rocks, posts and the like upon the banks, or between clumps of reeds growing in the water. From the outer lines the radii extend towards the centre or "hub"; the latter is open, and consists of a series of notched concentric lines, and these form a group by themselves. Beyond the hub there is a free space, and then a further series of larger and more widely separated concentric lines. The number of radii and concentrics varies somewhat, but the principle of construction is always the same. As a rule there are from eighteen to twenty-four radii, eight to fourteen concentrics, and five or six notched lines in the hub. The cocoon of *T. cylindrica* is round, about a quarter of an inch in diameter, fine and closely woven, white with green tufts; it is invariably fixed to some object near the web. In connection with the species just quoted, it is interesting to

note that it is able, when it drops upon still water, to skim across the surface. Certain spiders, such as those of the genus *Dolomedes*, Latr., have long been known to possess this habit, but one would hardly have associated such with the Argiopidae. Personally, I am inclined to think that so far as *Tetragnatha* is concerned it is only resorted to as a last resource,—that is, when the creature finds itself so situated, and with its retreat cut off. Indeed, if a floating stick or leaf be near, it will instantly avail itself of it. Dr. H. C. McCook has recorded an American spider—*T. grallator*, Hentz<sup>12</sup>—that has acquired this aquatic habit, but he also points out that when it is skimming over the surface of the water, it stands high upon its legs, raises its abdomen, and pays out threadlets of silk, much after the manner of aeronautic spiders, and that these threadlets act as a sail.

The Metæe introduce the student to a group of comparatively small, yet extremely brilliant spiders. The group consists of ten genera and many species. Of these genera two, *i.e.*, *Meta*, C. Koch, and *Argyropeira*, Emert., occur in Australia. The range of *Meta* is “Orbis totius, reg. temp. et calide”<sup>13</sup>; and of *Argyropeira*, “Orbis totius reg. tropicæ rarius sub-tropicæ.”<sup>14</sup> The genus *Orsinome*, Thor., although not yet known to occur in Australia, may nevertheless be hereafter recorded, at any rate from the more northern and tropical areas; at present its range is defined as “Malaisia; Polynesia et ins. Madagascar.”<sup>15</sup>

All our Australian species have been assigned by authors to the genus *Meta*, but notwithstanding this some are undoubtedly *Argyropeira*. One species described by L. Koch (from an immature female) is regarded by Thorell as a very young *Nephila maculata*, Fab.<sup>16</sup> namely *Meta ornata*. I am inclined to regard this, however, (notwithstanding the eminent position of the authority quoted), an error. There is in our cabinets a species of *Meta* from the Jenolan Caves district, which agrees so closely with Koch's description and figure, that I have no hesitation in assigning it to that author's species, namely, *Meta ornata*. Further, I have examined many species of Araneidæ from the Jenolan Caves district, and have not yet met with a *Nephila*; indeed, I doubt if that genus occurs there; the winter is too cold.

<sup>12</sup> McCook—American Spiders and their Spinning Work, 1889, i., pp. 158-161, figs 151, 152.

<sup>13</sup> Simon—Hist. Nat. des Araignées, 2nd ed., i., 1892, p. 735-6.

<sup>14</sup> Simon—*Loc. cit.*, p. 736.

<sup>15</sup> Simon—*Op. cit.*

<sup>16</sup> Thorell—Ragni Malesi e Papuana, i, p. iv., 1889; also iii., 1881, p. 150.

<sup>17</sup> Koch—Arach. Austr., i, p. 134, pl. xi., fig. 6.

Of the two genera known to occur in Australia, the forms included in the genus *Argyropeira* are much the brightest. This genus embraces such well-known and widely distributed species as *A. celebesiana*, Walck., and *A. granulata*, Walck., both of which are exceedingly common.

The webs of these spiders are perpendicular, orbicular, and very regular: the free zone separating the hub from the spirals is rather large. Attached to the framework of the snare there are numerous irregular lines, and these form an exceedingly complicated network. The ova-sac is floccose, yellow, and filled with concolorous eggs; it is usually attached to a neighbouring branch. *A. celebesiana*, and *A. granulata* are numerous enough in orchards and gardens around Sydney; they are also common in scrub-lands, and in parts of the bush that have been cleared.

#### Sub-family NEPHILINÆ.

(Fig. 53).

This sub-family is divided into four groups, namely, Phonognatheæ, Nephilææ, Clitætreæ, and Heremniææ, and of these the two first occur in Australia. The Phonognatheæ group containing three genera, is at present only known from Australia, and the species are few, but Simon considers that some Malaisian forms described under the generic names of *Epeira*, Auct., and *Milonia*, Thor., are in all probability referable to this group. The genera *Phonognatha*, occur in "N.-Hollandia et Tasmania," *Singotypna*, Sim., "N.-Hollandia," and *Deliochus*, Simon, "Nova-Hollandia et Tasmania."<sup>18</sup>

*Phonognatha graeffei*, L. K., = *Epeira graeffei*, L. K., and *Meta graeffei*, Keys.; *Singotypna melania*, L. K., = *Epeira melania*, L. K., and *Meta melania*, Keys.; *S. melanopygia*, L. K., = *E. melanopygia*, L. K.; and *Deliochus zelivira*, Keys., = *Meta zelivira*, Keys. All of these spiders are of medium size, and their webs and ova-sacs are similar to those of the Meteæ.

The Nephilææ include, according to Simon's classification, only one genus, namely, *Nephila*, Leach. In 1872 L. Koch founded a genus which he named *Nephilengys*,<sup>19</sup> and which Simon afterwards retired into the cool shades of synonymy. But his argument that *Nephilengys* runs into *Nephila* would, as pointed out by Hogg,<sup>20</sup> (who later restored it) "equally serve for connecting through this species all the genera from *Nephila* to certainly *Gea*, and perhaps *Epeira* (*Araneus*, Simon)."

*Nephilengys*, if it be permitted to stand, as I think it should, would include of course L. Koch's *N. schmeltzii* (Philippine Islands)

<sup>18</sup> Simon—Hist. Nat. des Araignées. 2nd ed., i., 1892, pp. 748-9.

<sup>19</sup> Simon—Loc. cit., pp. 750 and 755.

<sup>20</sup> Hogg—Proc. Roy. Soc. Vict., xi., 1899, pp. 138-9.

and *N. hofmani* (Borneo) as well as Hogg's *N. rainbowi* from the Upper Endeavour River, Queensland.

*Nephila* is almost entirely a tropical genus. Its range is "Orbis totius reg. tropicæ et rarius sub-tropicæ."<sup>21</sup> About a dozen species occur in Australia, and one of them *N. maculata*, Fab., the type of the genus, occurs throughout tropical Asia, Malaisia, and Oceania. It is indeed, the commonest species collected by Island missionaries. L. Koch, has described ten species from this continent; W. S. Macleay, one; and myself, five. Some of these appear to be varieties of *N. maculata*. The species are remarkable for the great disparity in size of the sexes, the male being a veritable pigmy in comparison with the female. The act of approaching the female when pairing is often fraught with grave danger to the male, indeed he often falls to her as prey. Nevertheless, it is apparent from observation that "his size protects him," for being so small he may at times approach without attracting her attention seeing that he invariably does so from the rear, but woe betide him if in his anxiety he vibrates the web ever so little. Having safely approached, the male makes a sudden spring which lands him on one of the hind legs of the female, from whence he nimbly scrambles on to her back, eventually working his way to the ventral position, where with his legs thrown round and clasping the abdomen he inserts his palpi into the epigynum. The act of coition accomplished, the male has still to exercise some care in quitting the web, for delay would be disastrous to him. A couple of seasons ago I made a curious observation, which proved that the female may on occasion, notwithstanding her immense size, succumb to the voracious appetite of the male. I had discovered a *Nephila ventricosa*, mihi, in her web; she had a male upon her back (abdomen), and I noted that his fangs were buried therein, and he was apparently—doubtless, after the act of coition—enjoying a meal. McCook has recorded a similar act of cannibalism in connection with *Araneus strix*, Hentz,<sup>22</sup> and Baron Walckenaer,<sup>23</sup> to quote McCook, "saw a male of *Epeira inclinata* take advantage of a female of his species, which was not able to stir without difficulty being full of eggs, to attack, garrote, and eat her." This species of cannibalism does not appear to have been often observed, but I doubt not it is more common than generally supposed.

The ova-sac of *N. edwardsi* and *N. ventricosa*, mihi, may be noted around Sydney from the middle of March to the end of April, or the commencement of May. The cocoons are oval and (fig. 53) enveloped in a dense but loosely woven mass of bright yellow silk.

<sup>21</sup> Simon—Hist. Nat. des Araignées, 2nd ed., i., 1892, p. 755.

<sup>22</sup> McCook—American Spiders and the Spinning Work, ii., 1890 p. 24.

<sup>23</sup> McCook—Loc. cit., Walckenaer, Apteres, i, p. 143.



Fig. 53. Nest of *N. re trivosa*, Ramb.

attached to and suspended amongst the stalks of plants adjacent to the web. The webs of our Sydney *Nephila*, and their strength to retain small birds accidentally ensnared have already been described by me.<sup>24</sup>

Much of the silk of these and congeneric spiders is employed by birds to line their nests. In addition to this *Nephila* silk is used by savage man for a variety of purposes. In some of the South Sea Islands it is sometimes applied by him to decorate

<sup>24</sup> Raintow—Proc. Linn. Soc. N. S. Wales, xx., 1895, pp. 354-359.

carved images, and in New Britain it is used as a material in the manufacture of "Smothering Caps." A specimen of the latter has been presented to the Trustees of the Australian Museum by Dr. J. C. Cox, President of the Board of Trustees. It is conical in shape, about 2ft.  $4\frac{1}{2}$ in. long and 8 inches round the base, somewhat flexible, and therefore capable of distension. In the manufacture of these caps a shaped frame is passed over and under the webs of orb-weaving spiders until a sufficiency of the material is felted thereon; it is then removed in one piece. It is said that these caps are used for smothering adulterous women. On the atoll of Funafuti, the natives utilise the webs of orb-weaving spiders for making nets to catch mosquitoes and other insects. A forked stick is converted into a hoop by tying together the extremities of the arms of the fork. This is then passed over and over through orbicular snares until the hoop is filled by a membrane of glutinous spider threads. With this implement any insect would be struck and meshed.<sup>25</sup>

Herenniee is a small group consisting of only one genus and a very few species. The genus *Herennia*, Thor., ranges through "Asia tropica, Melaisia et Papuasias."<sup>26</sup> It is not unreasonable therefore to assume that it may hereafter be recorded from Northern Queensland.

Family HYPOCHILIDÆ.

ECTATOSTICA TROGLODYTES, *Higg and Pett.*  
(Fig. 54).

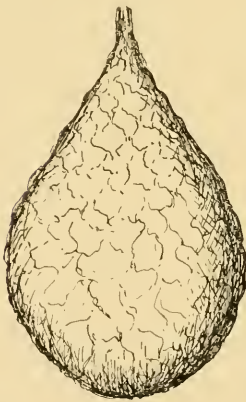

Fig. 54.

Nest of *E. troglodytes*,  
Higg. and Pett.

In a former volume of these Records I figured and redescribed Higgins and Petterd's species—*Ectatostica troglodytes* = *Theridion troglodytes*<sup>27</sup> and quoted from their paper<sup>28</sup> a note *re* the "nest" or cocoon of the species. Since the publication of my paper a cocoon has been added to the collection in the Australian Museum (fig. 54). It is pear shaped, and was suspended by a narrow neck; white, densely and closely woven, and filled with a large number of yellow eggs, the latter surrounded by a quantity of white loose feculent silk. The female hangs over her cocoon, and stoutly defends eggs and young.

<sup>25</sup> Rainbow—Aust. Mus. Mem., iii., 2, 1897, p. 96.

<sup>26</sup> Simon—Hist. Nat. des Araignées, Ed. 2, i., 1892, p. 759.

<sup>27</sup> Rainbow—Rec. Aust. Mus., v., 5, 1904, pp. 326-9, pl. xlvi., figs 1-4.

<sup>28</sup> Higgins and Petterd—Proc. Roy. Soc. Tas., 1883, p. 198.

ADDITIONS TO THE AVI-FAUNA OF THE COUNTY OF  
CUMBERLAND.

BY ALFRED J. NORTH, C.M.Z.S., Ornithologist.

In the "Proceedings of the Linnean Society of New South Wales" in December, 1888,<sup>1</sup> I recorded "A List of the Birds found in the County of Cumberland, New South Wales." It was a bare list of the species, without comment of any kind. Nearly a decade later in the "Handbook of Sydney and the County of Cumberland, for the use of the Members of the Australian Association for the Advancement of Science," I gave a second list of "The Birds of the County of Cumberland." In this list the species appeared under their respective orders and families, with brief notes as to their haunts, and localities where they could be found in the County. Of those species now added several were included in the first list, but omitted in the second. Two of them now restored *Edoliisoma tenuirostre* and *Munia castaneo-thorax* have since been found breeding, the former, regularly visiting and remaining to breed in the County. By far, however, the greater number of the additions are due to climatic influences, principally caused by periods of excessive drought inland, and to a less extent by coastal gales. Some of the additions are founded on donations made to the Trustees of the Australian Museum. Among the donors, not only of additions to the avi-fauna of the County, but of many rare species, may be especially mentioned, Mr. Henry Newcombe of Randwick. He has also been a frequent contributor to the Museum collections for upwards of a quarter of a century. Several of the species included in the present list, have been previously recorded at the time when they were obtained, either in the "Proceedings of the Linnean Society of New South Wales," or the "Records of the Australian Museum."

---

<sup>1</sup> North—Proc. Linn. Soc. N. S. Wales, (2), iii., 1888, p. 1773.

<sup>2</sup> North—Handbk. Austr. Assoc. Adv. Sci., Sydney, 1898, p. 68.

*Order* PASSERES.*Family* PTILONORHYNCHIDÆ.CHILAMYDODERA MACULATA, *Gould.**Spotted Bower-bird.*

Only a single example of this species has come under my notice. It was received in the flesh by the Trustees of the Australian Museum, and was shot in an apple tree in a garden at Smithfield, about twenty miles from Sydney, on the 19th May, 1902, by a son of Mr. James Stein, the donor, and during a severe drought inland. This specimen, a fine old adult male in perfect plumage, was exhibited at a meeting of the Linnean Society of New South Wales, on the 25th June, 1902.

*Family* CAMPOPHAGIDÆ.EDOLISOMA TENUIROSTRE, *Jardine.**Jardine's Caterpillar-eater.*

I first observed this species in the County of Cumberland at Waterfall in 1898, and later at Roseville, on the 20th October, 1900. It is a regular migrant, arriving in the latter locality on or about the same date every year, remaining to breed, and departing again about the end of January or early in February. Only two or three pairs visit the district, one's attention being attracted to them by their peculiar frog-like note. A nest found at Roseville, on the 30th November, 1901, was built in a forked horizontal branch of a *Casuarina suberosa*, and contained an incubated egg. This species is more numerous in parts of the adjoining County of Northumberland.

*Family* MELIPHAGIDÆ.ENTOMOPHILA PICTA, *Gould.**Painted Honey-eater.*

This rare Honey-eater is nomadic in habits and is chiefly an inhabitant of the inland portions of the State. On the 14th February, 1901, a nest and two eggs were taken at Fivedock, a suburb of Sydney, and the parent bird procured. A week later, collecting on behalf of the Trustees of the Australian Museum, Mr. R. Grant shot an adult male in the adjoining suburb of Abbotsford, and brought back with him an unfinished nest of this



species. This Honey-eater is undoubtedly one of the most beautiful of the large Family Meliphagida, and one with the most strikingly contrasted plumage.

PHILEMON CITREOCULARIS, *Gould.*

*Yellow-throated Friar-bird.*

This species was apparently driven to the coast by the severe drought of 1902. Mr. H. Newcombe presented a specimen in the flesh, that he had shot on the 31st May, 1902, at Kurnell. During the following month Mr. James Stein trapped one at Smithfield, and in July of the same year, Dr. James C. Cox, Crown Trustee, sent me a specimen for identification, obtained at Pittwater. Previously this species had not been recorded from the County of Cumberland.

ENTOMYZA CYANOTIS, *Latham.*

*Blue-faced Honey-eater.*

In my first "List of the Birds found in the County of Cumberland," published in the "Proceedings of the Linnean Society of New South Wales" in 1888,<sup>3</sup> I enumerated this species. "In my second list published in the "Handbook of Sydney and County of Cumberland"<sup>4</sup> in 1898, it was omitted, owing to the want of confirmatory evidence of its occurrence. I have never seen a specimen in the flesh, but find that I had overlooked a skin in the Reference Collection of the Australian Museum, obtained by Mr. George Masters at Rope's Creek, in July, 1869.

*Family ARTAMIDÆ.*

ARTAMUS ALBIVENTRIS, *Gould.*

*White-rumped Wood Swallow.*

Mr. H. Newcombe procured a specimen at Randwick on the 7th July, 1902, during the prolonged drought, when other inland species were driven to the coast. This is the only instance I have known of it occurring in the County.

<sup>3</sup> North—Proc. Linn. Soc. N. S. Wales. (2), iii., 1883, p. 1777.

<sup>4</sup> North—Handbk. Austr. Assoc. Adv. Sci., Sydney, 1898.

*Family* PLOCEIDÆ.MUNIA CASTANEOTHORAX, *Gould*.*Chestnut-breasted Finch.*

I recorded this species in my first "List of the Birds of the County of Cumberland" published in the "Proceedings of the Linnean Society of New South Wales."<sup>5</sup> It was omitted in my second list as Dr E. P. Ramsay believed the small flock of birds seen by him at "Yasmar," Dobroyde, Ashfield, was escaped cage-birds. Absolute proof of their occurrence in a wild state was afforded by Mr. A. F. B. Hull who observed this species at Freshwater, near Manly, and found nests with young in April, 1906. Previously in 1901, I had noted it in the southern parts of the adjoining County of Northumberland, where I was informed it bred.

*Order* PICARLÆ*Sub-order* COCCYGES.*Family* CUCULIDÆ.MISOCALIUS PALLIOLATUS, *Latham*.*Black-eared Cuckoo.*

An extremely rare species chiefly inhabiting the western portions of the State. An immature specimen procured by Mr. L. Harrison at Manly on the 13th January, 1906, is the only one I have seen that was obtained in the County of Cumberland.

*Order* HEMIPODIDÆ.*Family* TURNICIDÆ.TURNIX VELOX, *Gould*.*Swift-flying Turnix or "Butterfly-Quail."*

This species was included in my first list, but was omitted in the "Birds of the County of Cumberland," published in the Handbook of the "Australian Association for the Advancement of Science." Since then the only instance of its occurrence, that

---

<sup>5</sup> North—Proc. Linn. Soc. N. S. Wales, (2), iii., 1888, p. 1776.

has come under my notice, is based upon a specimen, received in the flesh, from the donor, Mr. A. M. N. Rose of Campbelltown, on the 31st January, 1902.

*Order* LIMICOLÆ.

*Family* CHARADRIIDÆ.

*Sub-Family* HIMANTOPODINÆ.

CLADORHYNCHUS LEUCOCEPHALUS, *Gould.*

*Banded Stilt.*

Six specimens obtained by Mr. H. Newcombe in November and December, 1902, are the only examples I have seen procured in the County.

*Sub-Family* TOTANINÆ.

HETERACTITIS BREVIPES, *Vieill.*

*Short-toed Sandpiper.*

Four specimens obtained by Mr. H. Newcombe at Coogee on the 2nd July, 1900. As with many other writers this species was referred to in my previous lists under the name of the closely allied form *Totanus incanus*, *Gmelin.*

*Order* STEGANOPODES.

*Family* PHAETHONTIDÆ.

PHAETON LEPTURUS, *Lacep. and Daudin.*

*White-tailed Tropic-bird.*

This addition to the avi-fauna of New South Wales, was duly recorded by me in June 1898<sup>6</sup> After disastrous easterly gales on the coast of New South Wales, an immature bird of this species was picked up by Mr. Henry Burns on the 14th of February 1898, on the shores of Botany Bay. It was in a dying condition, and was presented the following day in the flesh. There is no record of a specimen from any part of Australia in the list enumerated by Mr. Ogilvie Grant in his "Catalogue of Birds in the British Museum."

---

<sup>6</sup> North—Rec. Aust. Mus., iii., 1898, p. 89.

*Order* TUBINARES.*Family* DIOMEDEIDÆ.THALASSOGERON CAUTUS, *Gould.**Shy Albatros.*

I saw one of these birds at the entrance of Lavender Bay, on the 22nd September, 1905. It was resting on the water, but on the approach of a Milson's Point Ferry Steamer flew away, finally settling down again in Farm Cove.

Mr. R. S. Thomas, of South Clifton, captured one alive on the beach during the previous month, and presented it to the Trustees of the Australian Museum.

# THE RESULTS OF DEEP SEA INVESTIGATION IN THE TASMAN SEA.

## II.—THE EXPEDITION OF THE “WOY WOY.”

### I. FISHES AND CRUSTACEANS FROM EIGHT HUNDRED FATHOMS.

By ALLAN R. McCULLOCH, Zoologist.

(Plates lxiii.-lxv.).

In continuation of the investigations carried on by means of a grant from the Royal Society of London detailed on page 271 of these Records, Professor W. A. Haswell, M.A., made a second expedition on 26th to 27th October, 1906 in the “Woy Woy,” a boat that had already been engaged in this direction (*ante* p. 211). He kindly invited me to accompany him and has further honoured me by placing the Fishes and Crustacea in my hands for description. In the first instance, the Crustacea were undertaken by my lamented friend Mr. F. E. Grant, but the untimely death of that gentleman occurred before he had dealt with them.

The specimens here discussed were obtained in a single cast of a small trawl which Professor Haswell had built on the principle of one designed and successfully used by the Prince of Monaco. It was lowered in 800 fathoms at a point thirty-five miles due east of Sydney, on the 152nd Meridian.

Besides the subject of this paper, the trawl produced numerous representatives of Echinodermata, conspicuous among which were a hundred living specimens of *Porocidaris elegans* which choked the net, and with their long spines scraped most of the scales off the fishes that lay near them. Upon their arrival on deck fishes, crustaceans, and echinoderms alike were quite paralysed and rigid, while the stomachs and intestines protruded from the fishes' mouths and the eyes from their sockets. Only when they were placed in formalin did they exhibit any traces of life and then merely by erecting the fins and gill covers before they died.

At the suggestion of Professor Haswell, I examined the stomachs of the fishes for any invertebrates that might be undigested, but in every case they were quite empty, the fishes having probably vomited the contents at an early stage of their ascent.

## A.—PISCES.

Eight species were taken belonging to five families, and seven genera of which five have not been recorded from the coast of New South Wales before, and four are new to Australia. The species are—

- Optonurus denticulatus*, Rich.  
*Macrourus nigromaculatus*, sp. nov.  
*Celorhynchus fasciatus*, Günther.  
*Celorhynchus innotabilis*, sp. nov.  
*Trachichthys intermedius*, Hector.  
*Symphurus strictus*, var. *australis*, var. nov.  
*Scorpena percoides*, Rich.  
*Hoplichthys haswelli*, sp. nov.

## MACROURIDÆ.

OPTONURUS DENTICULATUS, *Richardson*.

*Macrourus denticulatus*, Richardson, Zool. "Erebus and Terror," 1848, p. 53, pl. xxxii., figs. 1-3.

Richardson's specimen appears to have had the tail incomplete, and in his figure it is indicated by dotted lines only. In three of the six of our specimens it is perfect and in these the total length is 6.2 times that of the head. The first dorsal spine is unarmed, and the second dorsal and anal fins have 153, 156, 134, and 144, 143, 125 rays respectively.

One other specimen is of interest inasmuch as though the tip of the tail is clearly missing, the wound has healed over, and the dorsal and anal rays have grown together around it, thus giving it the appearance of a perfect member.

MACROURUS NIGROMACULATUS, *sp. nov.*

(Plate lxiii., figs. 1, 1a).

D. II. 10-11, 143-150 ; A. 140-145 ; P. 20 ; V. 13-15.

Head 7, depth of body at first dorsal spine 6 to 6.7 in the length without the caudal rays.

Head compressed, a little longer than deep, cheeks vertical. Snout much shorter than the eye and but little overhanging the mouth, very obtusely pointed and with three bony angles which, however, are not prominent. Infraorbital ridge obscure. Interorbital space with an elongate-triangular depression, the apex

directed backwards. Eye very large, its upper margin just cutting the profile of the head. Maxillary extending to beneath the front margin of the pupil. Teeth in villiform bands in both jaws, the outer series being slightly enlarged. Angle of the preopercle not produced, its posterior margin directed upwards and backwards. Barbel rather longer than half the diameter of the eye.

Body compressed, very deep, its greatest depth being at the origin of the first dorsal and greater than the length of the head. The dorsal profile ascends rapidly to the first dorsal spine, whence it drops abruptly so that the fin is attached to the posterior slope of a prominent hump. The ventral profile ascends rapidly backward from the origin of the anal; the tail is therefore abruptly narrower than the trunk, but tapers uniformly to its tip. Scales small, armed with seven or eight rows of slender spines which overlap the edge; about sixteen in a transverse series between the origin of the first dorsal and the lateral line. Whole head scaly. Lateral line strongly arched over the pectoral fin.

Second dorsal spine serrate along its entire length, its tip fine and flexible, and rather longer than the depth of the body; posterior rays very small. Origin of the second dorsal separated from the first by a space longer than the base of the first. Anal originating below the second dorsal spine. Pectorals slender, 1.3 in the head, situated far in advance of the dorsal and a little behind the ventrals. Outer ventral ray produced, reaching beyond the origin of the anal. Vent placed midway between the origin of the ventrals and the anal.

Colour greyish, abdomen and posterior part of the head black. A large round black spot on the first dorsal fin. Ventrals black.

The differences between the young specimen and the adult lie in its having a larger eye, about two in the head, fewer teeth on the second dorsal spine and longer anal rays.

This species is nearest allied to *M. gibber*, Gilb. and Cram., but is distinguished by its larger eye and shorter snout. From *M. ectenes*, Gilb. and Cram. and *M. hirundo* Coll., which it also resembles, it differs in the fin formulae and the scales. It would enter the genus *Nezumia*, Jordan<sup>1</sup> which is separated from *Macrourus* by having an increased number of ventral rays, "13 to 15 instead of 7 to 10, as in all other *Macrouridae*," but as *M. gibber* has 12-13, and *M. semiquincunciatus*, Alc., *M. pumiliceps*, Alc., and *M. polylepis*, Alc., have 11-12, *Nezumia* is not here adopted. These species show the one to pass into the other by complete and gradual transition.

---

<sup>1</sup> Jordan—U. S. Fish. Comm. Bull., xxii., 1904, p. 620.

Type 227 mm. long from 800 fathoms, thirty-five miles east of Sydney. Four other specimens ranging from 114 mm. to 205 mm. taken with the type.

*CÆLORHYNCHUS FASCIATUS*, Günther.

*Maerurus (Cælorhynchus) fasciatus*, Gunther, Challenger Report, Zool., xxii., 1887, p. 129, pl. xxviii., fig. a.

D. xii. 101 ; A. 100 ; P. 17 ; V. 7. llat. 120.

A single specimen, 220 mm. long, which though not in entire agreement with Günther's description and figure, is so similar that despite the wide range between South America and the present locality, I hesitate to regard it as distinct. It differs from the Challenger figure in having the tail about two-thirds the length of the head longer, and produced into a fine point. The whole body is rather more slender and the anal rays are longer. The fins are dusky, and the outer anterior half of the anal is black. In all other characters it is in agreement with the figure.

It may be that the type specimen had the tail imperfect as in one of our specimens of *Optonurus denticulatus* (see p. 346) in which case these differences would be of little importance.

*CÆLORHYNCHUS INNOTABILIS*, *sp. nov.*

(Plate lxiii., figs. 2, 2a).

D. II. 8 ; P. 18 ; V. 7.

Greatest depth of the body 11·5 in the total length. Head including the spine on the snout 5·5 in the same. Snout 2·4 in the head, longer than the eye which is almost 3 in the head.

Snout broad, its terminal half tapering abruptly and tipped with a sharp triangular spine. Orbit elliptical, a little longer than the post-orbital portion of the head, and touching the dorsal profile. Interorbital space 1·8 in the longitudinal diameter of the eye. Width of the mouth at the angle of the gape nearly twice in the width of the head in the same line ; maxillary reaching to below the posterior margin of the eye. Barbel very small, one-fifth the length of the eye. Ridges on the head very pronounced. A median one from the rostral spine to between the first-third of the eyes. The supraorbital ridge extends round the posterior edge of the eye before turning off in a horizontal line to the upper end of the gill-opening. The inner pair of ridges branch off from the supraorbitals slightly in advance of the middle of the eye, and converge gently, becoming parallel till about the middle of their length, where they again separate a little. The spaces between the ridges, other than on the top of the head and the nape, are quite bare and formed of soft, membranous, and translucent skin



Body and tail very long and slender, covered with small scales of which there are 5 between the middle of the first dorsal fin and the lateral line, and 14 in the same row below. The scales on the sides have 5 sub-parallel rows of spines which overlap the edges.

Space between the two dorsals much shorter than the base of the first. Second dorsal spine smooth, not produced, and equal to about one-half the head in length; it is placed a little behind the vertical from the insertion of the ventrals, which are again posterior to the pectorals. Origin of the second dorsal behind that of the anal, its anterior rays about half the length of the eye; those of the anal slightly longer. Longest pectoral rays barely reaching to below the origin of the second dorsal. Outer ventral ray produced, overlapping the anterior anal rays and equal to those of the dorsal in length. Space between the ventrals and the vent shorter than the eye.

Colours, light grey with minute black specks. Iris, lips, belly and ventral fins black.

This species is characterised by its long and slender form. Without larger material it is impossible to be quite certain of its determination, but with the characters as presented by the young examples it appears to differ from all of the many described species. *C. tenuicauda*, Garm. is a closely allied species.

Type 138 mm. long from 800 fathoms, thirty-five miles east of Sydney. One other specimen 110 mm. long taken with the type.

#### BERYCIDÆ.

##### TRACHICHTHYS INTERMEDIUS, *Hector*.

*Trachichthys intermedius* (Hector), Günther, Challenger Report, Zool., xxii., 1887, p. 24, pl. v., fig. d.

One specimen, 120 mm. long, constitutes a new Australian record.

#### PLEURONECTIDÆ.

*SYMPHURUS STRICTUS*, *Gilbert*, *var. AUSTRALIS*, *var. nov.*

(Fig. 55),

*Symphurus strictus*, Gilbert, Bull. U. S. Fish. Comm., xxiii., pt. ii., 1903 (1905), p. 691, fig. 272.

D. 116; A. 103; V. 4; C. 14; scales lat. 130; sc. tr. 51.

Length of the head (in the median line of the body) 6.1, height of body 4 in the length without caudal. Eyes very small, the upper slightly in advance of the lower, and half the length of the

snout which is one fourth that of the head. Interorbital space scaly, the anterior part with a broad flap covering the posterior nostril. Anterior nostril tubular, situated midway between the end of the snout and the lower eye. Head and body, with the exception of the snout, covered on both sides with small ctenoid scales which on the coloured side, extend over the bases of the

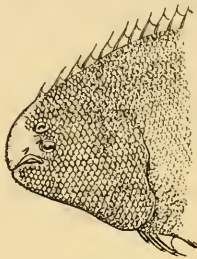

Fig. 55.

fin rays. No lateral line. The dorsal fin commences over the front edge of the eyes, its middle rays equal in length to those of the anal, 3.6 in the height of the body and shorter than the caudal, which is pointed. Anal separated from the ventral by a space nearly equal to the snout.

Colour light brown without darker markings. Peritoneum black, showing through the abdominal walls. Blind-side colourless.

A single specimen 120 mm. long agrees fairly well with Gilbert's description, but differs in having a somewhat deeper body and shorter head. The eyes also are smaller than as shown in his figure and the snout longer. In all other characters however it appears too closely related to *S. strictus* to admit of specific distinction.

## SCORPÆNIDÆ.

### SCORPENA (HELICOLENUS) PERCOIDES, *Richardson.*

*Sebastes percoides*, Richardson, Ann. Mag. Nat. Hist., ix., 1842, p. 384; Voy. "Ereb. and Terr.," ii., 1845, p. 23, pl. xv.

One specimen, a female with unripe ova, 363 mm. long. Colours in life, pink suffused with yellow, with indistinct darker cross-bars. Pectorals, dorsal and caudal pink, the spinous fin deeper coloured than the others. Ventrals and anal white. Iris golden, surrounded with pink.

(Note.—All the scales were rubbed off the sides by the spines of echini taken in the same haul. Otherwise the cross-bars may have been more marked).

Richardson assigned this species to the genus *Sebastes*, but was corrected by Günther<sup>2</sup> who transferred it to *Scorpena*. Waite<sup>3</sup>

<sup>2</sup> Günther—Challenger Rept., Zool., xxii., 1887, p. 17.

<sup>3</sup> Waite—Mem. Aust. Mus., iv., 1899, p. 100.

placed it under *Sebastapistes* which was considered by Jordan and Evermann<sup>4</sup> to be a synonym of *Scorpena*, and later by Jordan<sup>5</sup> as a close ally of the same.

I cannot refer to Street's diagnosis of *Sebastapistes*, which apparently includes only "numerous dwarf species less than three inches long" (Jordan *loc. cit.*) but as our fish presents all the characters of *Helicolenus*, a genus doubtfully distinct from *Scorpena*, I place it under the above heading.

There appears to be some considerable variation in the relative lengths of the dorsal spines of this species. The present specimen is in perfect agreement with Richardson's original description and figure, but a number of others of smaller size, including those taken by the "Thetis" Expedition, are rather better represented by McCoy's figure,<sup>6</sup> wherein the longest spines are higher than the anterior rays.

### HOPLICHTHYIDÆ.

#### HOPLICHTHYS HASWELLI, *sp. nov.*

(Plate lxiv.).

D. v. 14 ; A. 16 ; P. 14+4 ; V. I. 5 ; lateral plates 27.

Depth of body  $8\frac{3}{4}$ , length of head to opercular flap 2.6 in the length of the body without the caudal fin. Length of snout 2.74, diameter of eye 5.48 and width of head 1.15 in its length.

Snout broadly rounded, with a median notch at its extremity. The lateral profile of the head is formed by a minutely denticerous ridge which bears four large spines ; the first, which has a smaller spine at its base, placed before the anterior margin of the eye, another similar one before the posterior margin, a third directed inwards at the end of the preopercular margin, and the fourth and largest forming the preopercular spine. A bony plate, wider than the interorbital space, extends backwards from the nostrils, between which and the lateral margins is a soft fleshy area. Back of head covered with rough bony plates and smooth naked areas. The sculpture on the plates consists of minutely denticulated, radiating ridges, the centres of which are larger or smaller spines. The opercles bear three strong ridges which are armed with small spines along their length, and terminated by larger spines. A pair of large humeral plates, each bearing a strong spine.

<sup>4</sup> Jordan and Evermann—Fishes of N. and Middle America, ii., 1898, p. 1839.

<sup>5</sup> Jordan—Guide Study of Fishes, ii, 1905, p. 434.

<sup>6</sup> McCoy—Prodr. Zool. Viet., i., 1879, pl. 33 (not very good).

The lower jaw is longer than the upper. A broad band of villiform teeth in both jaws, the innermost ones being the largest. A very long band on each palatine, and a large patch on the vomer which sends backwards two other parallel rows. All the inner teeth are larger than those of the jaws. The maxillary reaches almost to the front margin of the orbit. Gill membranes united to the isthmus, without a free fold, and separated by a space equal to half the interorbital width.

Above the lateral series of plates and posterior to the first dorsal fin, are some widely scattered, thin, cycloid scales, almost entirely imbedded in the skin. On the caudal peduncle they are more numerous, overlapping and smaller. The large lateral plates are roughened by a number of minutely denticulated ridges radiating from the large blade-like spines, which latter increase in size backwards. The pores of the lateral line are placed below the middle of these spines, and there are no smaller secondary spines. The hinder edges of the plates are smooth and deeply cleft in the middle.

The spines of the first dorsal are slender, the second being the longest, 1.38 in the snout (this fin is malformed in the larger specimen, the measurement being therefore taken from the smaller one). The second dorsal ray is the highest and more than once and a half longer than the highest (7th) anal ray. The anal commences beneath the 2nd or 3rd dorsal ray and terminates far behind that fin. Caudal almost truncate, the upper rays a little longer than the lower. The four lower pectoral rays are free except for a low membrane at their extreme base. They are thickened, and longer than the rays above them. The following one or two rays may be also simple but are joined by membrane to their tips. The ventrals are inserted well in advance of the pectorals, the rays increasing in length backwards. Both specimens have a small anal papilla.

Colours in life pinkish yellow above, white beneath. Dorsals, caudal and pectorals pinkish, the latter finely edged with white. The vertical fins and tail with darker markings.

I have pleasure in associating with this fish the name of Professor W. A. Haswell, the leader of the expedition.

This species is closely allied to *H. platophris*, Jord. and Everm., but appears to be distinguished by its different fin formula, the character of the lateral plates, the lower pectoral rays being divided to their base, and by the shape of the snout.

Type 430 mm. long, from 800 fathoms, thirty-five miles east of Port Jackson. One other specimen, 340 mm. long, taken with the type.

## B.—CRUSTACEA.

The trawl obtained three species, two of which, *Latreillopsis petterdi*, Grant, and *Pandalus martius*, A. M.-Edw. are dealt with here. The third is reserved for further consideration.

## LATREILLIDÆ.

LATREILLOPSIS PETTERDI, *Grant*.

(Plate lxx.).

*Latreillopsis petterdi*, Grant, Proc. Linn. Soc. N. S. Wales, xxx., 1905, p. 317, pl. x., fig. 2.

A giant specimen with a carapace measuring 79 mm. long enables me to add further details to the original description of this species. It is a male, and though presenting characters markedly different from Grant's description and figure, a comparison with the type in the Museum collection, which is only 6.55 mm long, convinces me that it is the adult of this species. The following is a description of the specimen.

Carapace subquadrilateral, but the width across the hepatic regions narrower than the hinder margin; the length to the base of the rostral spine very little more than the greatest breadth, which is behind the middle of the length. Sides vertical, the greatest depth, which is at the base of the chelipeds, just half the length.

Rostral spine slightly deflexed, about half as long as the supraocular spines, its base broad and depressed. Supraoculars uptilted and armed with two spines, the one nearest the base directed outwards and upwards, and the other outwards only.

Whole carapace, with the exception of the frontal and hepatic regions, covered with small granules which are more numerous along the lateral and posterior margins. Regions moderately well defined. The middle and medio-lateral parts with deep grooves. Linea anomurica distinct. Epigastric region with two large sub-spiniform granules, and smaller approximated ones between them. Proto-, meso-, and metagastric regions each with a large tubercle, that of the first-named being spiniform and the anterior of a series of six arranged parallel with the sides of the carapace. Cardiac and epibranchial regions prominent, with larger (worn) tubercles. Hepatic region inflated, with three large mammiliform spines above and three smaller ones below. A similar spine at the anterior hepatic angle and another above the base of the antennæ.

Eye-stalks less than half the length of the supraocular spines, which do not conceal them from dorsal view ; eyes very large, though comparatively smaller than those of the young specimen.

Coxæ and ischia of all the pereopoda with spiniform granules below. Meri with spines on both margins which are largest behind, and each armed distally with a strong spine above ; their hinder and lower surfaces bespread with spiniform granules.

Chelipeds about  $2\frac{1}{4}$  the length of the carapace and slightly more than half that of the third pair of ambulatory legs. The carpus is granular. Hand very large and swollen, only a little deeper than thick and covered on both inner and outer faces with very small rounded granules, the largest of which tend to form rows. Fingers curved inwards, with widely spaced tufts of short bristly hairs, the mobile finger with a large blunt tooth near the base.

Ambulatory legs of the first to third pairs with the carpus almost smooth. The propodus is roughened with minute forwardly-directed spines which are most numerous below. Dactylus with five rows of spinules of which two are above, one on each side and one below.

Last pair of legs much shorter than the preceeding, a little longer than the chelipeds. Propodus short and broad with four slender spines placed close together on its hinder margin, into which the very small dactylus closes.

The ischium and merus of the maxilipeds are very long and narrow and coarsely granular. Their inner margins thickly clothed with long bristles. The following joints smooth and cylindrical. Exopodite slender, its basal portion granular.

All seven segments of the abdomen are distinct and faintly granular, and completely covering the space between the bases of the maxilipeds and legs. The middle line of segments 1-6 is raised and on 1-4 bears a small spine. Segments 3, 4, and 6 have also small spines on either side of the raised portion.

Colour in general pink, the carapace becoming whitish on the sides. Eyes orange above. Hands dark yellow, separated from the black fingers by a white interspace. Distal end of the joints of the ambulatory legs and the dactyli rose-colour, the latter with rows of yellow spines.

The most striking differences between the young and adult specimens are, in terms of the latter, the broader and much less quadrilateral form of the carapace, and the less prominent hepatic regions ; the granulations and spines of both carapace and legs though much stronger and more numerous, are not so long in

proportion. The two terminal joints of the last pair of legs are also less modified than in the young specimen.

### PANDALIDÆ.

PANDALUS (PLESIONIKA) MARTIUS, *A. M.-Edw.*

*Pandalus (Plesionika) martius* (A. M.-Edw.), Alcock, Cat. Crust. "Investigator" 1901, p. 95. Rathbun, Bull. U.S. Fish Comm., 1903 (1906), pt. iii., p. 914.

A large series, agreeing well with Alcock's detailed description. This species was dredged by the Challenger at Station 164a off Sydney, in 1,200 fathoms, while it has also been recorded from various localities eastward to the Kermadec and Hawaiian Islands and west through the Indian Ocean to the Mediterranean Sea.

### CÆLORHYNCHUS FASCIATUS, *Günther.*

As the foregoing was passing through the press I received the following letter from Dr. G. A. Boulenger regarding the type specimen.

"You are perfectly right in suspecting the specimen of *Cælorhynchus fasciatus* figured by Günther in the "Challenger Report" to have a mutilated tail. Its companion has the tail intact, and is therefore longer and ends in a fine point, as normal in the Macrourus. I have besides seen several further specimens obtained off the Cape of Good Hope by Dr. Gilchrist."

Eye-stalks less than half the length of the supraocular spines, which do not conceal them from dorsal view; eyes very large, though comparatively smaller than those of the young specimen.

Coxæ and ischia of all the pereopoda with spiniform granules below. Meri with spines on both margins which are largest behind, and each armed distally with a strong spine above; their hinder and lower surfaces bespread with spiniform granules.

Chelipeds about  $2\frac{1}{4}$  the length of the carapace and slightly more than half that of the third pair of ambulatory legs. The carpus is granular. Hand very large and swollen, only a little deeper than thick and covered on both inner and outer faces with very small rounded granules, the largest of which tend to form rows. Fingers curved inwards, with widely spaced tufts of short bristly hairs, the mobile finger with a large blunt tooth near the base.

#### Color of young specimen.

The most striking differences between the young and adult specimens are, in terms of the latter, the broader and much less quadrilateral form of the carapace, and the less prominent hepatic regions; the granulations and spines of both carapace and legs though much stronger and more numerous, are not so long in



proportion. The two terminal joints of the last pair of legs are also less modified than in the young specimen.

#### PANDALIDÆ.

PANDALUS (PLESIONIKA) MARTIUS, *A. M.-Edu.*

*Pandalus (Plesionika) martius* (A. M.-Edw.), Alcock, Cat. Crust. "Investigator" 1901, p. 95. Rathbun, Bull. U.S. Fish Comm., 1903 (1906), pt. iii., p. 914.

A large series, agreeing well with Alcock's detailed description. This species was dredged by the Challenger at Station 164a off Sydney, in 1,200 fathoms, while it has also been recorded from various localities eastward to the Kermadec and Hawaiian Islands and west through the Indian Ocean to the Mediterranean Sea.

THE RESULTS OF DEEP SEA INVESTIGATION IN THE  
TASMAN SEA.

II.—THE EXPEDITION OF THE “WOY WOY.”

2.—MOLLUSCA FROM EIGHT HUNDRED FATHOMS, THIRTY-FIVE  
MILES EAST OF SYDNEY.

By CHARLES HEDLEY.

(Plates lxvi.-lxvii.).

In continuation of the biological examination of the ocean floor off Sydney conducted by Professor W. A. Haswell with the aid of a grant from the Royal Society of London (as detailed ante p. 271) an excursion was made in the “Woy Woy,” on October 26-27, 1906. We proceeded thirty-five miles from the coast, and lowered the bucket dredge in an estimated depth of 800 fathoms. It returned nearly full of green ooze. <sup>1</sup> When the whole load was washed through a sieve of thirty-four to the inch, hardly more than a cupful was retained of shells, foraminifera, or such solid bodies. The only thing alive was a Tubicolous Annelid. From shallower depths of about a hundred fathoms, ten times as much matter would be left in the sieves. So large a proportion of silt to shells seems to indicate that deposition is here proceeding rapidly. I should also have inferred that the deposit of such finely divided matter implied a perfect calm, but my friend Mr. G. H. Halligan who has given these problems special attention, does not consider such a deduction necessary.

On the other hand the flagella of the antennæ in an undetermined prawn from this horizon extended for more than three and a half times the length of its body. Mr. A. R. McCulloch suggests that this enormous development would be manageable only in absolutely still water.

Both species and individuals were less abundant than in the samples of sea bottom previously examined. About sixty different kinds of shells were separated, about a third of which are new. From these the following are selected for description.

---

<sup>1</sup> For an account of our glauconite deposits, see Collet and Lee—Proc. Roy. Soc. Edinb., xxvi., 1906, p. 273.

*LIOTIA CAPITATA*, *sp. nov.*

(Plate lxvii., figs. 13, 14).

Shell minute, subdiscoidal, spire slightly elevate, umbilicus wide. Colour cream. Whorls three. Protoconch of a whorl and a half, tilted and inflated. Last whorl scarcely in contact with its predecessor, at last deeply descending. Sculpture, sharp projecting ring ribs, widely spaced on the last half whorl, but crowded on the penultimate, the interspaces and protoconch smooth. Aperture oval, oblique, entire, downwardly directed, fortified by a prominent ring varix. Height 0·6, major diam. 1·3, minor diam. 0·9 mm.

A single specimen.

The present is closely related to *Bifrontia pernambucensis*,<sup>2</sup> with which the apex especially associates it, but from which it differs by being about half the size and not involute. Though these are not typical *Liotia*, that genus seems to harmonise better with their appearance than does *Bifrontia*.

*TURRITELLA CURIALIS*, *sp. nov.*

(Plate lxvii., fig. 19).

Shell very small, turritid. Colour pale cream. Whorls eleven including a protoconch of two rounded whorls. Sculpture, the third, fourth, and fifth whorls have a single smooth spiral rib running between the centre of the whorl and the lower suture. From the sixth whorl onwards, this spiral develops conspicuous grains, about fifteen to a whorl, but finally these become obsolete behind the aperture. From the seventh to the last whorl two narrow, wide spaced smooth spiral lyrae revolve above the bead row. Five low spirals ornament the base. Aperture defective in all examples seen, but the direction of growth lines indicate a deep median sinus. Length, 7, breadth 2·95 mm.

Several specimens from 800 fathoms.

In size and shape this resembles *T. crenulata*, Donald,<sup>3</sup> but differs in the spiral sculpture.

<sup>2</sup> Watson—Chall. Rep., Zool., xv., 1886, p. 137, pl. viii., f. 13.

<sup>3</sup> Donald—Proc. Malacol. Soc., iv., 1900, p. 52, pl. v. f. 2.

RISSOA PROFUNDIOR, *sp. nov.*

(Plate lxxvii., fig. 15).

Shell small, ovate, turrated rimate. Colour cream. Whorls five. Sculpture, two apical whorls smooth, remainder with elevate, distant, arcuate, radial ribs, thirteen to a whorl, which gradually vanish on the base. Along the summit of each whorl runs a broad spiral band linking together the tops of the ribs. A few (six or seven) raised spiral threads traverse the base and periphery. Aperture broadly ovate, inner lip reflected. Length 2.95, breadth 1.85 mm.

A few specimens.

The present seems shorter and broader than *R. acuticostata*, Dall,<sup>4</sup> to which it has a strong general resemblance.

PYRENE BABYLONICA, *sp. nov.*

(Plate lxxvii., fig. 16).

Shell small, solid, glossy, conical, apex pointed, base contracted. Whorls five and a half, the lower narrowly but sharply tabulate. Colour cream. Sculpture, the protoconch consisting of a whorl and a half is smooth and very glossy, the next whorl is duller with incipient ribbing. On the last three whorls there are strong widely spaced perpendicular ribs, which on the penultimate number fourteen. Below the periphery they gradually vanish, above they terminate in a blunt point, the summits are linked together by an indefinite spiral cord. The anterior extremity is scored by six fine spiral grooves. Aperture oval, feebly denticulate within the outer lip, on the columellar wall a thick callus layer. Length, 5.5, breadth 2.5 mm.

Three imperfect specimens.

*Pyrene strix*, Watson,<sup>5</sup> appears to resemble this but is larger, without the denticules in the aperture and has a different apex.

It is curious that four widely differently species of the collection before me, viz., *P. babylonica*, *Rissoa profundior*, *Mitra miranda*, Smith and *Drillia challengerii*, Smith, affect the same style of ornament.

<sup>4</sup> Dall—Bull. Mus. Comp. Zool., xviii., 1889, pl. xix., f. 10.

<sup>5</sup> Watson—Chall. Rep., Zool., xv., 1886, p. 237, pl. xiii., f. 2.

ARCULARIA DIPSACOIDES, *sp. nov.*

(Plate lxvii., fig. 21).

Shell ovate, rather thin, remarkably tabulate. Whorls eight of which half are comprised in the protoconch. Colour, cream, except the protoconch which is pale purple. Sculpture, protoconch conical, smooth, with a peripheral keel which is just exposed above the suture of the succeeding whorls. In the adult whorls spiral threads reticulate radial riblets, producing sharp tuberculate granules at the point of intersection, on the last whorl there are eleven spirals and twenty-two radials, both cease on the base and vanish on the subsutural shelf, the radials mount the spire obliquely, between the riblets are fine radial threads. Behind the canal a broad furrow encircles the base. The aperture is without the thickening usual in the genus, which gives an unfinished aspect to the shell, outer lip sharp and denticulate by the external sculpture. Three rest stages on the last whorl are indicated by thin lamellæ followed by grooves. A thick callus layer is spread over the inner lip. Canal very short, recurved, the truncate base of the columella bent outwards. Length, 12, breadth 8 mm.

This species appears to be abundant and wide spread in deep water. Besides the present station in 800 fathoms, it was taken in plenty by Mr. W. F. Petterd and myself in 250 and 300 fathoms. It was misquoted in our report (ante p. 214) as *Nassa jacksonensis*, Q. & G.. Dr. J. C. Verco has shown me examples of *A. dipsacoides* which he dredged in deep water off the coast of S. Australia.

Of published species the nearest ally is *Nassa ophanilla*, Watson,<sup>6</sup> from deep water off New Zealand. The novelty is of smaller size, with smaller and more numerous granules.

The familiar *Nassa* of Lamarck<sup>7</sup> is not here employed because Dr. W. H. Dall<sup>8</sup> has pointed out that *Nassa* was earlier used by Bolten<sup>9</sup> with a different meaning, namely for the group of *Buccinum sertum*, Bruguière, generally known by Adams' name of *Iopus*.

---

<sup>6</sup> Watson—Chall. Rep., Zool., xv., 1886 p. 187, pl. xi., f. 9.

<sup>7</sup> Lamarck—Mem. Soc. Hist. Nat. Paris, 1799, p. 71.

<sup>8</sup> Dall—Journ. of Conch., xi., 1906, p. 295.

<sup>9</sup> Bolten—Mus. Bolten., (2), 1798, p. 132.

EPITONIUM BELLICOSUM, *sp. nov.*

(Plate lxvii., fig. 18).

Shell slender, turritid, imperforate. Whorls eight, first three smooth and tightly rolled, remainder so untwisted that the volutions are only connected by the tips of the lamellæ. Colour, milk white. Sculpture, thin, outstanding, rather curled lamellæ, which on the final whorl amount to seventeen, on the shoulder angled and produced in a sharp point, thence crossing the whorl obliquely, end applied to that of one of the preceding whorl and thus mounting the spire obliquely and continuously. Between the lamellæ the shell is quite smooth and glossy. Aperture sub-circular, lip reflected, the outer one developing the usual shoulder angle, the inner spread over curled ends of the basal lamellæ. Length, 7.5, breadth, 3.25 mm.

A few specimens from 800 fathoms and others from 250 fathoms twenty-three miles east of Sydney.

The novelty is related to *E. jukesianum*. Forbes,<sup>10</sup> but is distinguished by the expanded spiny lamellæ and consequent angle at the shoulder.

The name *Scalaria* for this genus has been generally abandoned. In substitution, *Scala* has been advanced,<sup>11</sup> but the anonymity of the Catalogue in which it appeared is fatal to its acceptance. Granting this it is necessary to fall back on Bolten's *Epitonium*,<sup>12</sup> recognised by De Boury<sup>13</sup> and others as applicable to the genus.

CANCELLARIA SCOBINA, *Hedley and Petterd.*

*Cancellaria scobina*, Hedley and Petterd, *ante*, p. 222.

This species did not occur in the 800 fathom haul, but is now introduced to remark on synonymy. Since last writing on deep sea shells, I have had an opportunity of comparing an example of *C. scobina*, from 80 fathoms, off Narrabeen, with the type of

<sup>10</sup> Forbes—Voy. "Rattlesnake," ii., 1852, p. 383, pl. iii., f. 7.

<sup>11</sup> Melvill—Journ. of Conch., x., 1904, p. 340.

<sup>12</sup> Bolten—Mus. Bolt., (2), 1798, p. 91.

<sup>13</sup> De Boury—Mon. des Scaldæ, 1886, p. x.

*Cancellaria micra*, Tate,<sup>14</sup> in the Tate Collection, University Museum, Adelaide. The fossil has more and finer spirals, but weaker radials. In size, shape, and other respects they are identical. My conclusion is that the recent *C. scobina* may be regarded as a slight variation of the fossil *C. micra*.

PHILINE OSCITANS, *sp. nov.*

(Plate lxvii., fig. 17).

Shell small, opaque, moderately solid, oblong-ovate. Spire not concealed, plane, of two and a half rapidly increasing whorls, separated by a deep sutural furrow. Sculptured by spiral rows of small close punctures, radially undulate with rather coarse incremental lines. Colour, pale yellow. Aperture very large, rounded anteriorly. Columella with a heavy callus. Outer lip free at the vertex, ending in an acute angle. Length, 2, breadth, 1.6 mm.

A single specimen from 800 fathoms. On reconsidering the species noticed (ante p. 288) as *P. trapezia* from 80 fathoms off Narrabeen, I find that these specimens belong to the present form. *Philine trapezia*, Hedley,<sup>15</sup> is related but is narrower, thin, and possesses a distinct and characteristic angle.

LEDA PALA, *sp. nov.*

(Plate lxvi., fig. 1).

Shell small, smooth, inequilateral, moderately inflated, the rostrum not differentiated from the remainder of the valve, with a slight pearly sheen. Colour, olive-buff. Umbo prominent, anterior and ventral margins rounded, posterior dorsal margin concave. Hinge with 10 posterior and 8 anterior teeth. Specimen drawn is—height, 2.85, length, 4.25; depth of single valve 1.15 mm. Another fractured valve is 4.1 mm. high.

Numerous separate valves from 800 fathoms.

The novelty approaches *Leda oblonga*, Pelseneer,<sup>16</sup> from the Antarctic, but is less pointed posteriorly.

<sup>14</sup> Tate—Trans. Roy. Soc. S. Austr., xi., 1889, p. 158, pl. x., f. 8.

<sup>15</sup> Hedley—Proc. Linn. Soc. N. S. Wales, xxvi., 1901, p. 704.

<sup>16</sup> Pelseneer—Result V, y. "Belgica," Moll., 1903, p. 23, pl. vi., f. 79-80 (as *L. antarctica*, p. 69).

LEDA FORTIS, *sp. nov.*

(Plate lxvi., fig. 2, 3).

Shell small, solid, smooth, nearly equilateral, subtriangular, rather inflated. Colour cream. Sculpture delicate growth lines. Rostrum short and broad, with an angular ridge. Dorsal margins meeting at an acute angle. Anterior and ventral margins rounded. Hinge with twelve teeth on each side. Height, 3·7; length 4·2; depth of single valve, 1·45 mm.

Several separate valves.

This species appears to belong to the sub-genus *Jupiteria*.<sup>17</sup>

NUCULA DILECTA, *Smith.*

*Nucula dilecta*, Smith, Proc. Zool. Soc., 1891, p. 442, pl. xxxv., f. 23.

Of common occurrence in the vicinity of the type locality is a *Nucula* which coincides with the account of *Nucula dilecta* and which is accordingly identified as such. But this involves adding *N. dilecta* to the synonymy of *Nucula obliqua*, Lamarek, the nomenclature of which was discussed in dealing with the "Thetis" mollusca.<sup>18</sup>

CUSPIDARIA ALVEATA, *sp. nov.*

(Plate lxvi., fig. 6).

Shell much inflated, nearly equilateral, umbo prominent, dorsal margin rather straight, anterior perpendicularly truncate, ventral rounded, posterior scarcely sinuate, rostrum hardly apparent. Colour cream. Sculpture, medially there are faint radiating impressed lines which vanish on the anterior quarter, but posteriorly gradually pass into deep and wide furrows. These furrows notch the margin and are parted by sharp elevated ribs of which about ten are stronger than the rest, the broadest furrows contain each a small interstitial riblet. Except the smooth umbo the whole surface is over-run by fine close concentric threads which bead the crests of the ribs. Length, 9·5; height, 8; depth of single valve 3 mm.

A single valve and a few fragments were procured.

<sup>17</sup> Sacco—Moll Terr. Tert. Piedmont, pt. xxvi., 1898, p. 56.

<sup>18</sup> Hedley—Mem. Austr. Mus., iv., 5, 1902, p. 292.



The posterior radial ribbing recalls *C. alcocki*, Smith<sup>19</sup> from the Bay of Bengal, from which the abbreviated rostrum readily distinguished the Australian species.

*THYASIRA ALBIGENA*, *sp. nov.*

(Plate lxvi., fig. 4, 5).

Shell minute, rather higher than long, translucent with faint growth lines. Anterior margin slightly sinuate, ventral rather straight, posterior rounded. Fold almost obsolete. Umbo prominent, median, incurved. Muscle scars opaque, solid, projecting above the interior surface and visible from the outside. Height, 2; length, 1.9; depth of single valve, 0.75 mm.

A few separate valves.

This species is very distinct from any yet recorded from Australia. It appears to belong to the sub-genus *Axinulus*,<sup>20</sup> characterised by the absence of the fold, but is narrower with more prominent umbo than any referred to that group. The white cheeks of the opaque adductor scars contrasted with the translucent shell are a convenient recognition mark for the species.

*LUCINA INDUTA*, *sp. nov.*

(Plate lxvi., fig. 11, 12).

Shell minute, very thin, brittle, glossy, white, concealed beneath a thick hard brown mass which cakes, cracks and splits off when dry. In shape subcordate, rounded anteriorly, subangled posteriorly, beaks prominent incurved. Lunule absent. Sculpture, irregular concentric undulations and striations. No muscle scars visible. Hinge, the valve margin is produced under the umbo to simulate a cardinal tooth, the ligament occupies a narrow groove. Length, 3; height, 2.65 mm.

Several complete specimens, from 800 fathoms.

As usual with thin shells the muscle scars are invisible, indeed so few salient characters are presented that the systematic position of the species is uncertain. Possibly it may enter *Vaticinaria*.<sup>21</sup>

<sup>19</sup> Smith—Ann. Mag. Nat. Hist., (6), xiv., 1894, p. 170, pl. v., f. 8.

<sup>20</sup> Verrill and Bush—Proc. U. S. Nat. Mus., xx., 1898, p. 790.

<sup>21</sup> Dall—Proc. U. S. Nat. Mus., xxiii., 1901, p. 830.

*TURQUETIA INTEGR*A, *sp. nov.*

(Plate lxvi., fig. 7, 8, 9, 10).

Shell small, moderately solid, rather inflated, nearly equilateral, oblong, higher behind than before, dorsal margin straight, anterior and posterior rounded, ventral slightly sinuated. Colour cream. Umbo inflated, prominent. A slight shallow median sulcus externally. Sculpture: fine irregular incremental lines. Hinge, a narrow external ligament, no laterals, a tubercular subumbonal cardinal and socket in each valve. Pallial line entire. Height, 3.5, length, 6; depth of single valve 1.5 mm.

A few separate valves were taken in 800 fathoms. My figure and description is based on a better example dredged in 250 fathoms, twenty-three miles east of Sydney by Mr. Petterd and myself.

The generic allocation of this species has been a matter of difficulty to me, and I have taken refuge, though not with feelings of security, in *Turquetia*. This at least corresponds to the extent of having a simple pallial line, no laterals and one cardinal in each valve. Our species is larger and has not the short truncate posterior side of the type. *Turquetia* was proposed by Velain<sup>22</sup> for a small bivalve from St. Paul Island in the Indian Ocean. Its hinge was more fully explained by Bernard<sup>23</sup>.

---

<sup>22</sup> Velain—Archiv. Zool. Exper., vi., 1877, p. 134, pl. v., f. 15-17.

<sup>23</sup> Bernard—Bull. Mus. Hist. Nat., iv., 1898, p. 84, f. 5.

# NORTH QUEENSLAND ETHNOGRAPHY.<sup>1</sup>

BULLETIN No. 9.

## BURIAL CEREMONIES, AND DISPOSAL OF THE DEAD.

By WALTER E. ROTH, Magistrate of the Pomeroon District, British Guiana; late Chief Protector of Aborigines, Queensland; Corresponding Member of the Anthropological Society, Berlin, the Anthropological Institute, London, etc.

(Plates lxxviii.-lxxxiv., figs. 56-60).

### CONTENTS.

- Sect. 1. Introduction.  
2. Pennefather River Ceremonies.  
3. Lower Gulf of Carpentaria Coast.  
4. Princess Charlotte Bay.  
5. Cape Bedford.  
6. Bloomfield River.  
7. Tully River.  
8. Russell River.  
9. Boulia District.  
10. Cloncurry District.  
11. Upper Georgina River District.  
12. Rockhampton District.  
13. Brisbane District.

1. The interpretation of many of the gruesome details embodied in the following pages will be rendered intelligible by bearing in mind that, speaking generally, the main purport of the ceremonies connected with the disposal of the dead is to avenge the deceased,

---

<sup>1</sup> Bulletins 1-8 inclusive were presented to both Houses of Parliament in Brisbane (see Queensland Parliamentary Papers, 1901-1906), and subsequently printed and published by the Government Printer (George Arthur Vaughan). The collections, on which much of the matter contained in these "Bulletins" depends, having now passed into the possession of the Trustees of the Australian Museum, Dr. Roth's notes will from time to time appear in the "Records."—Editor.

and by so doing, to insure the well-being of the survivors. Death, disease and accident are not natural phenomena in that they are believed to be due directly or indirectly to human agency,<sup>2</sup> to some enemy in the flesh or spirit<sup>3</sup> dooming the individual to a particular form of death *e.g.* by lightning, flood, spear: it is this spirit of the dead in one form or another that brings all their troubles and dangers to the living, and hence the anxiety of the latter to satisfy its claims to the last farthing. Furthermore, the influence for good or for evil of such spirits is to be judged from the bodies whence they have been originally derived,<sup>4</sup> with the result that the spirits of women, children, infirm and invalid old men, whom, during life, the survivors had no reason to fear, need not be bothered about in the way of ceremonial to the same extent as is considered necessary with the more virile of the men.<sup>5</sup> Deceased warriors have to be well propitiated to prevent them returning to do evil to the living. On these lines, the differences in the funeral obsequies depending upon the prowess, sex, age, etc. of the departed can be accounted for, minor distinctions in the methods of holding the inquest and discovering the culprit varying with the modifications in local superstitions.

Again, this ignorance of the true meaning of death leads to difficulties in recognising the period of its occurrence,<sup>6</sup> the exact time of the spirit's release from its fleshy prison; these difficulties are all the more excusable when it is remembered that the spirit, vital principle,<sup>7</sup> etc., may be associated either with the shadow, breath, heart, after-birth, ears or nose, and hence can be seen, heard, smelt, etc. As a consequence, it comes about that the deceased may speak and be spoken to, that he may be supplied with victuals at the grave-side, that he may be fixed in the best position suitable to allow of him watching the ceremonial dances etc. carried out in his especial honour, and that he may be decorated to such an extent as will satisfy his vanity to the full. It thus also follows that only when the spirit has been propitiated and avenged (by the sacrifice of another's, etc.) that what remains of

<sup>2</sup> Bull. 5—Sects. 113, 114.

<sup>3</sup> Bull. 5—Sects. 115, 116.

<sup>4</sup> Bull. 5—Sect. 65 *et seq.*, 74, etc.

<sup>5</sup> Bull. 5—The names of females which are necessarily tabu after death, Sect. 72.

<sup>6</sup> The Pitta Pitta natives of Boulia use the same word *i-chi* to express the verbs to die, to lie down.

<sup>7</sup> Bull. 5—Sects. 65 to 70.

the corpse is finally disposed of for good and all, that the deceased's property is divided, the widow taken to wife, and the signs of mourning discarded.

The significance of the eating of the body wholly, or in part, is certainly very difficult to understand. The practice is found indulged in by perhaps only the few immediate relatives to practically the entire camp, while the flesh eaten may be limited to that of virile men only, or again, male and female, old and young, may all be partaken of. The natives will admit that their feelings in the matter are prompted by sentiments akin to love and affection, by hunger, by ideas of sanitation,<sup>8</sup> by a sense of punishment and spite,<sup>9</sup> and by fear.<sup>10</sup> Without any leading question, and I have made the enquiry over and over again for years past, I have never yet succeeded in learning from an aboriginal, living under native conditions, that the individual who eats human flesh benefits in any way by acquiring the moral or physical qualities of the person made a meal off: no male, with any respect for himself, would wish to obtain the attributes of a woman or child.

In all cases, the widow becomes ultimately the property of one or other of her late husband's group- or blood-brothers.<sup>11</sup> On the Bloomfield River when a single man dies, the woman to whom he may have been betrothed, but not yet cohabited with, may be betrothed again, or married straight away. The widow, though she may be found now and again even after her re-marriage wearing her late husband's necklet, forehead band, etc., has nowhere any legal right to his property, chiefly consisting of fighting-weapons, which usually passes to one of his brothers.

The deceased's hut is usually burnt, or taken to pieces.

White and red, one or other, or both, are the colours adopted by the mourners: the former would seem to savour rather of grief pure and simple, the latter being more signifiatory of the avenging sentiment. Elsewhere<sup>12</sup> will be seen a description of the various decorations peculiar to such circumstances, some of them donned only according to the age, sex, rank, etc. of the deceased individual, whilst others (such as the cross-shoulder

<sup>8</sup> *i.e.* to prevent exposure of the body with concomitant "stinking."

<sup>9</sup> Bull. 3—Sect. 38.

<sup>10</sup> Safe in the knowledge that having eaten the corpse, the impossibility of itself or its spirit returning to do them harm is assured.

<sup>11</sup> See Marriage.—Widows.

<sup>12</sup> See Decoration.—Clothing.

ornaments) which in certain districts may be absolutely distinctive of the period of mourning may in other areas have no such significant importance whatever.

2. On the Pennefather River, which is fairly typical of the procedures usually followed in the upper portions of Cape York Peninsula, differences in the burial ceremonies vary much with the age and sex of the individual concerned. Old men and women, as well as young women, are buried within a day or two after decease in the neighbourhood of the camping-ground, and the camp shifted. Children are usually put out of sight directly after death, though sometimes they may be carried about, wrapped up in bark, until they get dried, before being stowed away rather than buried, among the roots of a tree, in a cave, etc. The father of the child does not visibly appear to be much concerned over its death, though the mother takes it to heart, and will put on mourning in the form of shell necklaces and chest ornaments which appear to be used only in the case of deaths of infants and children: the necklaces are placed either around the neck or from one shoulder across to be opposite armpit, and are made of *Solen*, *Olivca* and *Columbella* shells, while the special chest-ornaments are manufactured from the pearl shell, or *Mallemus*. When young men die the body is at once put into a sheet of bark, bound round and round, and slung to a pole supported by two forks,<sup>13</sup> but in the neighbourhood of Margaret Bay, the body may be slung up without any bark covering except a dilly-bag or two over the head (Pl. lxviii., fig. 1). Until such time as the corpse becomes dried, the number of months depending upon the season, etc., there is a singing and stamping performance taking place over it morning and evening. The mourners both male and female cover themselves completely with charcoal, and with beeswax stick on their forelock anything of a red colour, usually either a feather of the Blue Mountain Paroquet, or (the women) a flower of *Erythrina vespertilio*: the women in addition tie a particular kind of fibre-string (Bull. 2—Sect. 15) round the belly and arms, this string being often coloured red, and on the Peninsula Coast-line, certainly in the neighbourhood of Pennefather River and Margaret Bay, may wear a special kind of cap manufactured on the same pattern as the local dilly-bag; it is known as a Nggara (NGG).<sup>14</sup> While the men sit or stand around the slung corpse,

<sup>13</sup> These two forked uprights often give the only clue to the charred remains scattered around.

<sup>14</sup> Capital letters expressed in this manner were used by Dr. Roth throughout the former Bulletins to indicate names of the various tribes referred to. Thus NGG means the Nggerikudi Tribe of the Pennefather and Batavia Rivers. See Bull. 3, p. 3—Editor.

the women, advancing from a distance in pairs, keep singing and stamping as they approach: the stamping consists of a simultaneous jerking movement of both feet, the dust being thrown up with each jerk. There is a belief that by thus stamping there is a chance of bringing the life, vital principle, etc., (the Ngai or Cho-i<sup>15</sup>) back into the dead body: it is curious to note that the women make the same steps when an individual has a fainting fit<sup>16</sup>. If the young man met his death in the water a corresponding dance takes place in that element, the throwing up of the dust with the feet being now replaced by the splashing of the water with the hands. During the intervals between the morning and evening ceremonies, the women sit underneath the pole on which the corpse is tied. The body is finally burnt, with the exception of the head, the fibula bones (NGG, pau-uto or pau-to), the soles of the feet (NGG, Ko-e-ana), and the fleshy portions of the fronts of the thighs. Where the corpse is burnt, the nearest tree is marked with a sloping vertical cut, and the camp shifted: it is believed that when once the body is cremated, there is no more chance of the Cho-i coming back in the flesh, but that it hovers somewhere about the bush. The decapitated head is carried about in a piece of bark, or a dilly-bag, etc., by the mother. The fibula-bones are wrapped in match-box bean or tea-tree bark, tied round and round with fibre-twine (raddled or not) and further decorated with Emu, Blue Mountain Paroquet, Cockatoo, or Native-Companion feathers (Pl. lxix): such a pau-to is slung either from around the forehead so as to hang over the nape of the neck, or else over the fore-arm. The individual who thus carries these personal mementoes is a son of the deceased's sister: the onus of preserving these relics may thus fall upon two, three, or more men sometimes. Furthermore, the portions of deceased's flesh (thighs, and feet) when originally cut from the corpse are baked in the ashes, and cut up into little bits to be eaten one or two at a time morning and evening by the same individual or individuals who are responsible for the pau-to. The eating process takes from two to three months, sometimes longer, to complete, and throughout all this period the person remains dumb, and is known as *tè-itima*: he is supposed to actually lose the power of speech, and though going about his business as usual, expresses himself only by signs, claps his hands if he wants to attract other people's attention, maintains the signs of mourning, and lets his

---

<sup>15</sup> Bull 5—Sect. 68.

<sup>16</sup> Bull 5—Sect. 70, last paragraph.

hair grow.<sup>17</sup> But during all this loss of speech, the *té-itima*, when done with the eating of the human flesh, has gradually discovered the murderer who doomed the deceased, and by the time that he is convinced of the identity, he finds himself in the centre of a group of old men bending towards him with their faces to the ground: speech returning, he commences with a guttural, then a babble, and so gradually expresses himself more and more distinctly when he gives his hearers the name of the guilty party. He subsequently makes an *ombo*, or death-charm, in the form of three or four bone-needles<sup>18</sup> splintered from the fibula which he has been carrying with him. With this *ombo* the deceased is subsequently avenged on the murderer, either at the hands of the victim's sister's son as already mentioned, or should a convenient opportunity present itself, by the victim's mother's-father's-brother's son. Should the *ombo* fail to take immediate effect the accused may have to stand the ordeal of having spears thrown at him,<sup>19</sup> and this may lead to general fighting and trouble.

3. Down the Lower Gulf Coast, *e.g.*, on the Lower Mitchell, Nassau, and Staaten Rivers, very little reliable information is forthcoming concerning procedures, relative to the disposal of the dead. In large measure this is due to the natives being still in their pristine condition, and frightened of strangers, European settlements few and far between, and no interpreters available. As far as my investigations led me, however, I was satisfied that with one or two variations, the funeral obsequies are run generally speaking, on the same lines as at the Pennefather River. One such variation is that during the period of discovering the individual guilty of killing the deceased, the nearer relatives in place of losing their powers of speech, have to avoid eating red-meats, *e.g.* opossum, bandicoot, kangaroo, cattle, such foods as iguana, &c., being permissible. A singular restriction from red meats by the nearer relatives has also been met with amongst the Maytown and Middle Palmer River Natives (Koko-minni Blacks). Furthermore, instead of carrying about the deceased's fibula, etc., or *pau-to*, the avenging relatives wear in similar position an ornament covered with *Abrus* seeds, which is said to contain portions of deceased's flesh (Pl. lxx.) this same decoration may on occasion thus become the sign of a challenge to fight. This ornament

<sup>17</sup> I have seen such dumb men even at the Mapoon Mission (Batavia River) so late as 1898, and since then on the Embley and Archer Rivers, and at the Moreton Electric Telegraph Office.

<sup>18</sup> Bull. 5—Sect. 136.

<sup>19</sup> Bull. 8—Sect. 13.



(KML. lin-ji-ila), on the Middle Palmer River is about six inches long, gradually enlarging towards its extremity, formed on a basis of black cement substance encircled on its upper half with kangaroo twine, and studded over its lower with *Abrus precatorius* or sometimes *Adeanthera abrosperma* berries. When the berries are not obtainable, the kangaroo twine may be alone employed; it is of course only used by males.

4. At Princess Charlotte Bay, although every effort is made to prevent a fatal termination to sickness or accident within the precincts of a camp, by removing the moribund patient to a distance, there appears to be no compunction about bringing the corpse back immediately after death, and temporarily burying it well within the camping ground. The restrictions of the tabu are applied to the actual spot where death takes place. The mourners, men and women, alternately sleep at and cry over the grave, wear mourning belts (men) or chain strings (women) and cover themselves with mud. The belts, similar to those at Cape Bedford, are wound round the waists, and are made of a central core of opossum-, or human-hair string, around which another twine is tightly coiled.<sup>20</sup> The chain-strings<sup>21</sup> are worn either over one shoulder across to, and under the opposite arm-pit, or else round the neck, one individual thus wearing three different sets at the same time. After some three or four days, when the friends and relatives who have been sent for are gathered round, the body is exhumed, and packed up in a piece of bark the ends of which overlap like a tongue, while the sides are sewn across in single boot-lace style. In this fashion the corpse is carried about from camp to camp for a long period, many months maybe, indeed until such time as the deceased tells his brother, uncle, etc., who it was that doomed or put him to death. But should he not choose to tell, his relatives will find out for themselves by means of hair-twine made from hair removed from the corpse. As this is being manufactured and rolled and stretched along the thigh,<sup>22</sup> the names of suspected persons are called aloud; the name at which it breaks is that of the person who committed the deed. If the individual thus detected lives in some other district, the hair-twine is mended, forwarded to one of the deceased's relatives in that neighbourhood who takes his revenge and sends it back when completed, in fact the return of the twine shows that the alleged assailant has paid the forfeit with his life. On occasion, especially in the case of women and

<sup>20</sup> Bull. 1.—Section 15.

<sup>21</sup> Bull. 1.—Section 12.

<sup>22</sup> Bull. 1.—Section 2.

children, the mourner will watch night after night at the grave to try and find out the guilty party. At any rate, when once what is considered to be sufficient proof is forthcoming as to the identity of the murderer, he is followed about for many a long day, so that he should forget all about it and not have his suspicions aroused until a suitable opportunity occurs for either spearing or choking him, especially when no one else is present. But should the alleged culprit get some private information that he is "wanted" on the charge, so to speak, he may prove too cunning and wide-awake to be caught. Under such circumstances he will be waited for some evening while in camp, perhaps engaged on a corroboree, etc., when he will be struck with a spear from somewhere under cover of the darkness, or the shelter of the trees. On examining the spear which has struck him, his mates will see that it is mud-painted, and by this sign will recognise why he has been put out of the way. If by any chance the alleged murderer should eventually escape vengeance, the life of his mother, brother, or sister will be forfeited, and only when such penalty has been paid does the victim's corpse cease its peregrinations to be permanently buried deep down in the ground.

5. The following account of the disposal of the dead at Cape Bedford was written for me (1902) in her own language<sup>23</sup> by Mulun<sup>24</sup> one of the black women at the local Hope Valley Mission, and thanks to the superintendents, the Revs. Schwarz and Poland, I am enabled to supply its free translation.<sup>25</sup>

Gurabudo	bama-ngai	duyu	merelil.	Bama	bieni,	bama
Again	men	death	tell.	Man	(when)	died, man
warka-ngamu	ungga-dir-budongo	gura	gauwal	budongo		
altogether	a crying-with-very	and	scream	very		
bar-ngal.	Ngamu,	kanal,	dirnggur,	bemor,		
cry.	Mother,	elder-sister,	younger-sister,	fathers' sister,		
	gammi,	babbi,	ungga warka	batcheltchil.	Gura	
mother's mother,	father's mother,	cry	many	cry.	And	
mangal	danangan-ngun	kambul	wudye-go	kmndandal;	yirmbi,	
hand	their-with	belly	violently	strike;	lips,	
numbul,	kambogo	galmba.	Gura	bobowe	walli	dakan
cheeks,	head	too.	And	ground-on	here-and-there	down

<sup>23</sup> Koko-yimidir, the grammar and structure of which is detailed in Bull. 2.

<sup>24</sup> Name signifying a Quandong.

<sup>25</sup> The description given is very complete, except that dealing with the inquest which she, on account of her sex, was not allowed to see. This portion, however, of the burial service is given in more detail in connection with the Bloomfield River Natives who are only about forty miles distant.

dadara gura dalmbakabaya bobo-we gura bobo  
 go and throw (themselves) down ground-on and soil  
 dambanbar mangal-nda, gura tamal-nda galmba bobo dabel-il.  
 throw hands-with, and feet-with too ground kick.

Gura bama mala wudyego kaimbalmbal. Dirainggur ngai  
 And man guilty vehemently (they) scold. Old men  
 galmba unggga batchelchil warka. Gura dana galmba gari  
 also cry cry very. But they too not  
 yimidir unggga-we-go, gari bama kaimbalmbal, galmba gari  
 similar crying-with, not man scold, also not  
 bobo-we dalmbakabaya gura mangal-nda dodi danangan-go  
 ground-on throw (themselves) and hands-with body their-own  
 galmba gari kundandal. Galmba gari bama unggawe-go  
 too not strike. Also (they) not men crying-for  
 kaimbalmbal. Garko bera dana bama mala, mako-badaigo  
 scold. By-and-bye certainly they man guilty, always  
 ganil-nda kaimbalmbal. Ungga katabatega pitaigo dana  
 song-with scold. Cry having broken a little they  
 gamai-ga dudara. Gura dodi danangan-go durng-galng-gal;  
 white-clay for go (quick). And body their smear;  
 dirainggur galmba gamai-nda durng-galng-gal mundal-go. Gura  
 old men too white clay with smear some only. And  
 ngamu, peba burla duy-uwego unggga batchil-budo, burlangan  
 mother, father both the dead-for cry cry-indeed, them both  
 gamai bamal mandendi, garko burla durng-galng-gaya  
 clay men fetch, by-and-bye those two smear each other  
 gamai-budongo yitar kambogo-we gura dodi-we galmba.  
 clay-much put head-on and body-on too.

Bama yaba bieni garka-ngun diral nangu-nga  
 Man elder-brother died, younger-brother by wife him-of  
 damalnal: nulu ngando bama yendu-me-gal bur-ngal-ngaya,  
 spears: he women men others-before will pull  
 yerka-ngu. Kalka nangun-ga yerka yendu-mun karbalbal,  
 boy's on account of. Spear his own boy another-by hold,  
 ngando gari dama-tinu. Ngalan ngurku pulega dana nima  
 woman not shall throw. Sun evening falling they grave  
 garbarenggo bakalkal, galbaigo yoku daba bandendil walmba  
 middle in right dig long wood sticks cut platform  
 ngada-galbaigo yitarnu-ngo, dikan galmba bur-ngal-ngal  
 (knee-extended, *i.e.*) in a line put-to, grass also pull,  
 walmba-wego ngada-galbaigo nambur ngaranu-ngo bodu  
 platform-for in a line resting-place spread-by, bark  
 galmba mandendi wanggar-mun baichar-nu. Daku namo-dir  
 also fetch above-from to cover. Things there-with

badatega, dana duyū mandendi. Ngamu nangu nulu kana finished, they corpse fetch. Mother his she first nima-we garbarbar unggā-dir-go. Gura kanal, dirnggur, grave-in jumps cry-with. And elder-sister, younger-sister, yumur, labbi, gammi, bemor, son(daughter), father's mother, father's father, father's younger sister dana duyū wogur-gur budo unggā-dirgo. Duyū yitarnu-ngo they corpse follow indeed crying-with. Corpse to put in-in order to garko ngamu nangu dawil wakur kadanu. Gura nula by-and-bye mother his they call outside to come. And she wakur kadaiga, dana nima-we yitar bodu-n baiteha, outside having come, they (him) grave-in put, bark-with cover, gura bobo-n kobarbil. Bama dana duyū kobarbil, gura dana and soil-with bury. Men they corpse bury, and those ngando-ngai duyū danaigo woguren, dana nawaigo nima-we women corpse before followed, they just-there grave-at unggā batcheltchil-budo. Duyū kana kobarbi-ga, garko a-weeping cry indeed. Corpse once buried, then ngando-ngai mundal kadara nima-we unggā batchinu-ngo. Gura women some come grave-to a cry to cry. And dana nanggor nawaigo nima-we-go dagalgaya mundal they camp just-there grave-at-just build some (coming) naka-nun, mundal goarnggar, mundal dilar-nun mundal east-from, some west-in, some south-from, some gunggar-nun. Dana wabalego nanggor dagalgaya gulboigo : north-from. They wide-spread camp build together :

duyū garbar-enggo(w)umana. Dana wudur nobungo barbega, corpse middle-in rests. They night one having-slept, ngando nulu unggā-dirgo kadara, gura dirainggur-be the woman she a crying-with comes, and old-men-to kambogo walli (w)umalma nangu kundanu-ngo, dana nangu head roundabout gives it to strike-for to, they her galmba kundandal. Gura milbiren. Ngando garbi-bud-ongo too strike. Also wommera-with. Woman blood-much-very dodi nangu-go ngalba garbi. Gura dana ngando-ngai body her-own all blood And they the women ngalan-be gumbin burnggar wogur-gur duyū-ngu. Namo-dir day-during string mourning-string plait the dead-for. This badatega, garko gumbin-ngai gamai-ngu-nda durng-galng-gal, finished, then strings clay-with smear, garko manu-we goma yirngalngal gura gamur godera-me then neck-on together wind-round and arm-pit two-under yitar, burnga galmba wambirdamal kambogo-we yitarnu-ngo. put, dilly-bag also tear up head-on to put-for.

Namo-dir murga ngando-ngai wogur-gur, dirainggur gari,  
 These only women plait, old-men not,  
 dirainggur-be murga ngando-ngai wogur, gura dana birbalbal.  
 old men-for only women plait, and they wear(them)

Gura peba-rgan burnga-ngai dumbelmbil gura diar yitar  
 And father-by dilly-bags breaking(tearing) and hole put-in  
 kambogo burnggatinu gura dana namodir-be burnggaya gura  
 head to enter and they this-in enter and  
 manu-we yitar. Gura burnga dodu nangume buntjil-buntjil-go  
 neck-on put. And dilly-bag body his-on incomplete (broken)  
 burngalngal gura yendu pita kambogo-we yitar. Murga  
 pulls and another small one head-on places. Only  
 dirainggur yendu-mun gumbi-ngo gamai-go mandendi, gari  
 old men others-by string-only clay-only taken, not  
 warka-nganu yimidir ngando-ngai. Gura ngando dana nangu  
 altogether like women. And woman they her  
 kundaiga, dana nangu gari gura kuli-dir. Dirlen dana  
 having struck, they her no more angry-with. Therefore they  
 ngando-ngai yimidir nganni kundal! Ngai! burla  
 the women like this why strike! What a question! both  
 danaigo ngamburgo gilgi mate-ga kaimbalmbate-ga  
 before alive jealousy became-because quarrelled-because  
 kundandate-ga nangu muri-budo. Dana ngando-ngai  
 struck-because her (they) forbade-indeed. They women  
 namodir-ga-budo kundandal, dirainggur galuba wabu-bakal  
 that-for-indeed strike, old men too spear in the leg  
 yimi-yimidir-gala diral bienega. Garko bama godera dadara  
 just the same wife having died. By-and-bye men two go  
 melbi-dir duyungu dauun-ngai dawinu-ngo. Gura burla  
 message-with corpse-for friends call-to. And these two  
 bobo yuba bama-dir-go wamega, burla dudun-be-go  
 place close to men-with having approached, they the way-on  
 gamai-ngu-nda dodu burlangan-go durnggalnggal. Garko  
 clay-with body their-own smear. By-and-bye  
 bama-gal gamai-tchir-go miraya, burlangan nadega  
 men-before clay-with appear, them having seen  
 gauwal-tchir-go bama yendu-me merelil. Garko burla yerhngargo  
 scream-with men other-to tell. Then they separate  
 dagaya garko burlangan bama nobun-il wamil melbi-dir.  
 sit down then them man one approaches message-with.

Gura burla melbi nangun-gal meril-budo duyungu galuba  
 And they message him-before tell-indeed the dead also  
 meril. Gura nulu melbi duyungu meril-budo.  
 tell. And he message corpse-on-account of tells indeed

Ngando-ngai melbi duyu-ngu nadega dana gauwaltchir-go

Women message corpse-of having heard they scream-with  
 unggu batcheltchil gura dalmbakabalbaya bobo-we, gura  
 weeping cry and throw themselves ground-on, and  
 bama kaimbalmbal. Dirainggur galmba unggu batchilil gura  
 man blame. Old men also wailing cry and (but)  
 gari gauwal-tchirgo galmba gari bama kaimbalmbal unggu-we-go,  
 not scream-with also not man blame crying,  
 garko bera dana ganil-nda kaimbalmbal makobadaigo.  
 by-and-bye certainly they song-with blame always.

Gura dana wudur godera barbega gura dana kadara  
 And they nights two having slept then they come  
 duyu-ngu, dirainggur ngando-ngai galmba. Warka-ngamu  
 the dead-for, old men women too. All collectively  
 gari, mundal-go bera. Gura dana bobo yuba  
 not, some certainly. And they place close to  
 wamega duyu-dir-go danungun danangan damalmal  
 having approached corpse-with friends their spear  
 duyu-ngu. Gura ngandongai unggu-dir-go kadara.  
 dead man-on account of. And women crying-with come.

Gura dana duyu yuba wamega dana nima-we unggu-dir-go  
 And they corpse close having come they grave-at cry-with  
 dagalgaya gura unggu batcheltchil, dir-ainggur galmba.  
 sit down and wailing cry old men too.

Dauungun dirlen danangan ngan-ni damalmal? yimidir gura  
 Friends therefore them why spear? Similarly also  
 nulu danangan-gal netchin dadarai-ga gura bienega nulu  
 he them-before always went-because and having died he  
 dauun danangan kana-ngan-go gari wamega danangan  
 friends their from the very first not having met them (he)  
 dube-ga-budo. Namongu-budo dana yimidar damalmal.  
 left-because-indeed. Therefore-indeed they like-this spear.

Gura dana duyu nima-we budur kundo-kundo bantchentchi  
 And they corpse grave-in nights many attend on  
 duyu kana kada manatinu. Duyu kana kada balkai-ga, bama  
 corpse first foul to become. Corpse once foul made, man  
 nobungo nulu warbi-dirgo dadara gurluggo bandinu  
 one he tomahawk-with goes bark-trough to cut  
 duyu-ngu. Gura nulu bandega gurluggo-dirgo kadara,  
 corpse-for. And he having cut bark trough-with (he) comes,  
 nulu gurabudo yoku-we bauwal ngara warnaganu-ngo dallel  
 he again fire-in cooks bark to take off-for light  
 gural. Gura ngolu kadaltchal gura pegur-nda  
 makes. And crinkled extremity ties up and wooden peg-with

bakal gura bebir dia ngada-galbaiyo bakalkal  
 pierces and edge holes knee-extended (*i.e.* in a line) digs  
 gumbin birbanu-ngo. Gura gurlnggo ganui-nda  
 string to wind on-for. And bark trough white-clay with  
 durnggalnggal woba-n galuba durnggal gurnerngurnern  
 smear red clay-with also smear piebald  
 gural walu-budongo (w)unanu-ngo; ngunu-ngun  
 (he) makes appearance-very become-to: the mother-by  
 gumbin galbai-galbai wogurgur duyu kadanu-ngo. Daku  
 string very long plaits corpse to tie up-for. Things  
 namodir badatega dana gurabudo barbil.  
 these finished they again sleep.

Dabadabaiga dana duyungu burntchirngaraya, duyu  
 By sunrise they corpse-for will gather corpse  
 warnganu-ngo. Manu dirainggur bera ngandongai dana  
 to take out-for. Only men of course women they  
 nimawe ngudo-kadalmul dana netchin yerlנגgar-go ninggal  
 grave-in not-come they always separately sit  
 nanggor daitchen-be gura ngamu yubaigo unnga  
 camp freed from the 'tabu' and mother close by cry  
 batchetchil ngambai-go. Gura dana duyu warngalugal  
 wails closed (*i.e.* not taking notice). And they corpse take out  
 gurlnggowe yitar-nungo. Gura dodi duyu-we dana  
 trough put into-to. And body corpse-of they  
 warka-ngamu-ngun gari karbal, murga dowe  
 all collectively-by not hold, only wife's brother-in-law  
 nangu-mun dodi nangu karbal, gura gurlnggo-we yitar,  
 him-by body of him holds, and trough-in puts,  
 kambogo galmba, mundal banggar nima-we-go dubil, gurlnggo  
 head also, some flesh grave-in leaves, trough  
 gayin kadai-ga. Gura dirainggur dana warka-ngamu nima-we  
 full comes-because. And old men they altogether grave-to  
 kadai, dana dumul nadinu-ngo nangu kanaigo ngambur-go  
 having come, they splinter see-to him first (when) alive  
 kundaiga, damaiga, bandega. Namu-ngango-gala dana dumul  
 having struck, speared, cut. Therefrom-verity they splinter  
 banggar nangu-me nadinu. Gura dana dumul nangu  
 flesh his-in will see. And they splinter his  
 nadega, garko wornda bobo-n kobarbil.  
 having seen, then the empty (*i.e.* pretended) soil-in bury.  
 Nayun badatega garko nulu gurabudo gurlnggo gumbin-il  
 This finished then he again trough string-with  
 wudyego kadaltchal. Nayun badatega, garko duyudirgo  
 firmly ties. This completed, then corpse-with

gurlnggo mumbal gural gura yandal. Yandaiga namongango  
 trough on-the-head makes and stands up. Having risen thence  
 nulu dindal-budo-ngo dudara wauw-u-ngun nangu dirbaiga-budo  
 he quick-very runs spirit-by him abducted-because  
 duyu-dir-go. Gura nangu dauaigo kundai gurlnggo nawaigo  
 corpse-with. And him once killed trough just there  
 pulelil. Gura nula gimil namalma nangu kundai-ga: gimil  
 fallsdown. And he stick sees him killed-with: stick  
 kana nadega nulu ngundu kadara duyudirgo. Gura bama  
 once having seen he back comes corpse-with. And men  
 warka-ngamu dana nangu nima-wego bantehentehi gura nulu  
 altogether they him grave-at await and he  
 danangan-gal kadaiga nulu gimil meril nangu  
 them-to having come he stick shews him  
 kundaiga: namongan-budo dana bama mala gural gura  
 having killed-with: therefrom-indeed they man guilty declare and  
 kaimbambal. Garko dana warkangamu nima-ngoal kadara  
 blame. By and by they altogether grave-from come  
 duyu-dirgo nanggor daitehen-be gura duyu melu-we  
 corpe-with camp freed from 'tabu'-in and corpse shade-in  
 yitar. Garko ngandongai kadara duyu-ngu unggga  
 put. By-and-bye women come corpse-on account of a wailing  
 batchinu-ngo gura dana unggga katabatega dana  
 to cry for and they wailing having broken off they  
 kadagai birbalbal bobo yendume dakatinu gura  
 moveable-possessions gather place other-on to sit down and  
 dana dadara. Dirainggur nobungo nawaigo naudaya nulu  
 they go. Old man one there will remain he  
 pirra-wego ninggalnggal watchi mala nadinu-ngo. Gura  
 foliage-behind sits spirit guilty to see-for. And  
 dana dadaiga wutchi-ngai wau-wu nganggoigo kadara nima gu,  
 they having gone spirits breath quickly come grave-to  
 unggadirgo, gau-wal-tchirgo, gamai-tchirgo, kalka-dirgo,  
 wailing-with, screaming-with, clay-with, spear-with,  
 millir-tchirgo, yoku-dir-go, diral-tchirgo, pitagur-tchirgo.  
 wommera-with, wood-with, wives-with, children-with.

Gura nulu wauwu mala namalma nangu damanu gura nangu  
 And he spirit guilty looks for him to spear and him  
 nadega nulu nangu damanu. Gura nulu nangu damaiga  
 having seen he him will-spear. And he him havingspeared  
 dana gauwal-tchirgo gura numbur-tchirgo dudara gura  
 they screaming-with and noise-with run away and  
 bobo-we burnggalngga ya warimana ya-budo, gura danangan-ga  
 ground-into enter will disappear-indeed, and them-from



bobo wudje-go nangarngaralaya gura nulu mala-n yoku  
 earth vehemently will shake and he guilty-at wood  
 mulbango karbalbal. Gura dana wauwu-ngai warimanati-  
 firmly holds. And they spirits having disappeared-  
 budo, bobo kana nangaren nulu yoku dubil gura kadara  
 indeed, earth first shook he wood lets go and comes  
 gura dirainggur-be melbi meril wutchi-ngai warka-ngamu  
 and old men-to news tells spirits altogether  
 wamega gura yendu damaiga nangaren-budo.  
 having seen and one havingspeared (earth)having shaken-indeed.

Merelil gura dana wauwu nima-ngu kadarai: nayun  
 (He) tells (them) also they spirits gsave-to came those (only)  
 gari yendu: wauwu peba ngamu gura dauuu-gai danangan-  
 not others; spirits father, mother and friends them-  
 gala nulu nadetchi: gura nulu wauwu yendu damai  
 indeed he saw: and he spirit another speared  
 nayun dauun bama yendu-me. Gura dana kanaigo bama  
 this one friend mea others-of. And they before men  
 duyu bantchentchi gura bobo dubil. Ngando-ngai bobo nayun  
 corpse waited at and place leave. Women place this  
 gari-budondo wamiada, dudan namodir-be galmba gari  
 not at all should come to, road the same-on also not  
 kada-nda, purai galmba gari puda-nda bobo tabul-ngan.  
 should travel, water also not should drink, place 'tabu'-with.  
 Murga namo-dir tabul dirainggur pudaral: ngandongai  
 Only there-with tabu old men drink: women  
 pudanda danangan kundanda, dana namo-ngubudo yinil,  
 would drink them would kill, they therefore-indeed fright,  
 dana netchin dudan yendu-me dadara: murga dirainggur  
 they always road other-on go: only old men  
 dudan-go dadara. Gura duyu mokul matega kana, dana  
 road-on go. And corpse old has become first, they  
 moari guru walar duyu-wego wokelkil gura kadagai  
 hair and beard corpse-on account of cut off and property  
 nangu-nga bauwalal, gari warka-ngamu, mundal-go bera.  
 his-of burn, not all together, some-only of course.  
 Ngando-ngai galmba moari wokil. Moari kana wokega garko  
 Women also hair cut. Hair once have cut then  
 dana unggu batcheltchil warka-ngamu duyu-ngu. Gura  
 they weeping cry all together the dead-for. And  
 kabir-kabir belumayar-ngai dana yinil manaya, danangan  
 girls widows they fright become, them  
 manega-mu, dana moari wokega. Dana moari wokega dana  
 would take, they hair having cut. They hair having cut they

galmba bama manana gura belumayar garka-ngun  
 also men take and widow younger brother-by  
 mana.  
 taken.

The following is the free rendering of the foregoing :—

“Again, I will tell you about men’s burials. When a man dies, all the others set up a great crying and wailing. Especially do the deceased’s mother, elder and younger sister, father’s sister, mother’s mother and father’s mother lament very much. Furthermore, with their hands they violently beat their belly, lips, cheeks and head. And they get down on the ground here and there and throw themselves about, at the same time casting up soil with their hands and kicking the ground. And vehemently they blame the person or persons whom they consider are guilty of having killed him. The old men also cry very much but not as continuously as the women and they do not scold anyone as yet : neither do they throw themselves on the ground nor beat their body with their hands, nor do they blame anyone while crying : afterwards, of course, in a special kind of wail,<sup>26</sup> they cry and blame the man who is believed to be the cause of deceased’s death—this they do for a long time. When they have ceased crying they haste to get white clay to smear over their body. Only the dead man’s father and mother continue crying, and for them the others fetch clay, and they also smear it over their head and body. When one’s elder brother dies the younger one prepares to spear the wife of the deceased and pulls her about before the others—because of the man’s death : but one of them gets hold of the spear and prevents him wounding the woman.<sup>27</sup> At sundown they dig a grave<sup>28</sup> right in the centre of the camp, and cut long wooden sticks, to make a platform with, by putting them all in one line<sup>29</sup> and spreading grass over them. They also get some bark to cover this from above. After all that is done, they fetch the corpse. The deceased’s mother jumps crying into the grave, whilst the elder and younger sister, daughter, father’s mother and father, and father’s younger sister follow the corpse, they

<sup>26</sup> Ganil = a sort of plaintive burial song.

<sup>27</sup> The idea of this is to shew that during life, in their domestic quarrels, the wife may have occasionally got the better of the deal, and accordingly the surviving brother by attempting to spear her, shews that he is getting even with her.

<sup>28</sup> Face to the west, but reason for this observance is unknown, and a fire kept alight in the close vicinity.

<sup>29</sup> *Lit.*—like the knee extended.

also crying. In order to get the corpse into the grave, they have to ask the mother to step out. And when she has done so, they put in the corpse, cover it with bark, and then the whole with soil. Then the grave diggers as well as the women who had followed the corpse to the grave, commence to cry there again. Once the corpse is buried, some of the other women approach the grave for lamentation. And coming from all directions—east, west, south and north, they build a camp of considerable size around the grave, the corpse resting in the centre. Next day, the dead man's wife comes along crying, offering her head to all the men around to be struck; and they strike her too with a wommera until she is covered with blood. During the day, the women plait mourning strings<sup>30</sup> for the dead. This done, they smear a lot of strings with clay and wind them around their necks and the two arm-pits: they tear up dilly-bags and pull them over their heads. These of course are plaited, only by the women, not by the men, but they give the bags to them to put on. The deceased's father also tears some up and makes an opening into them big enough to let his head go through and wears them round his neck: furthermore, he draws some all over his body, and a small one over his head (Pl. lxxviii., fig. 3). The other men only just use the strings [belts]<sup>31</sup> or the white clay, not everything like the women.<sup>32</sup> When the striking ceremony with the wife is over, they are no longer angry with her. But why do they hit the woman at all! What a question! Because when her husband was alive, they both had been jealous of each other, and had quarrelled and fought: this they could not approve of, and they therefore strike the woman just in the same way as the old men spear the husband in the leg after his wife's death.<sup>33</sup> By and bye, two of the men go off as messengers to invite the friends for the funeral, but before they get to the camp they smear their bodies with white clay and so put in an appearance: as soon as the people visited see them coming, they shout it out to all the others. Then the messengers separate, and sit apart at a distance from the camp, whence an individual will approach to hear what they have to say: they tell him all the news, also of the occurrence of the death: and the person who has approached passes on

<sup>30</sup> Described in Bull. 1—Sect. 12.

<sup>31</sup> In the case of the males, who wear them around the waist, the mourning-belt is of a different pattern, and is described in Bull. 1—Sect. 15.

<sup>32</sup> If bee's wax is available both male and female mourners will fix up their hair with it into thorns.

<sup>33</sup> *i.e.* to cry quits—see previous footnote.

the news (see Bull. 8—Sect. 8). When the women hear this message, they cry out and scream, throw themselves on the ground, and blame the individual whom they deem to have caused the death: the men also do a cry, but not so loud as the women, nor do they blame anyone while crying: but later on they always do so in a special kind of wail (= ganil). After two days they leave for the burial service, men and women, not all of them, but some. And when they get close to the place where the corpse is lying, the visitors, *i.e.* the deceased's friends, throw spears at them on the dead man's account. The women are crying all the way to the grave, at the side of which they sit down still crying, the men doing the same. But why do these visiting friends of the deceased throw spears at them? Because the dead man had always travelled with them, but had died among his own people without having been to see them (the visitors) for a long time previously, just as if he had left them altogether. This is the reason for the spear-throwing.<sup>34</sup> They then keep the corpse in the grave for many days until it gets putrid. Then one man goes away with a tomahawk to cut out the bark-trough to wrap the corpse in. This bark which he brings back with him, he puts in the fire to get the sap out so as to peel it better. Then he ties up the crinkled-extremities<sup>35</sup> of the trough, pierces them with a wooden pin, and in the same straight line pierces holes along the edges of the trough for the string to go through, from side to side when finally sewn up (Bull. 7, fig. 226). Then he smears it with white- and red-clay to make it look pie-bald and give it a nice appearance, while the mother of the deceased plaits a very long string to tie up the corpse with. When all that is finished, they pass another night over it. By sunrise they will assemble again on account of the corpse, to take it out of the grave, which of course is only done by the men. No women will then be at the grave. Separate from one another they now continue to sit in their camp, from which the 'tabu' has been removed, while the mother cries by herself not far away without taking notice of anything. And in the meantime they take the corpse out of the grave and put it in the bark trough. But no one touches the body except the wife's brother-in-law, *i.e.*, deceased's brother who

---

<sup>34</sup> In other words, although the deceased used to wander about, and be friendly with the visitors, he had not been to see them for a long time past, and accordingly his death could not be due to their agency: on the other hand, by throwing the spears at his own people, the visitors shew whom they consider responsible for it.

<sup>35</sup> Ngolu = front of the ankle which is always more or less wrinkled or creased.

opens it, etc. : he also wraps it up within the trough, including the head. Some of the flesh is left in the grave because of the trough being full. Now all the men come to the grave to find the 'splinter' which is believed to remain in the dead man's flesh, and with which he was struck, speared, or cut by the one who doomed him<sup>36</sup> while he was alive ; and when they find it, as they pretend to do, they bury it in the soil with the remains. After this, the brother ties up the corpse in the trough quite firmly, puts it on his head,<sup>37</sup> and stands up. Then he runs away from there as fast as he can, being dragged along by the corpse's spirit, and on the very spot where the man was originally doomed<sup>38</sup> the trough falls off. And he sees the stick with which the deceased had been doomed, and directly he sees it he brings it back with the corpse. All the others are waiting for him at the grave, and having joined them he shews them the stick. Thus they recognise the guilty man, *i.e.*, the owner of this stick, and are angry with him. By-and-bye they all leave the grave, and taking the trough to the camp from which the 'tabu' is now removed, put it in the shade. Then the women come forth again to cry over it, and when this is done they take up their moveable-possessions and shift their camp somewhere else. One old-man only remains there, hiding himself behind bushes in order to see the spirit<sup>39</sup> of the guilty one. And as soon as the others are gone the spirits quickly appear at the grave wailing and screaming, painted with white clay, carrying spears, wommeras, and pieces of wood, and also having their wives and children with them. But the watcher looks for the guilty one to spear him and does so when he sees him. Having speared him, the others run away screaming and rattling, disappearing into the ground. And through them the earth quakes violently but the one who spears the guilty individual holds firmly to the bushes. When the spirits are quite gone, and the earth has finished shaking, the old-man lets go his hold of the bushes, comes back and tells the others about his having closely seen all the spirits, about his spearing one of them, and about the earth shaking. The spirits that came to the grave were those of deceased's father and mother and friends, no others, and those only had he seen ; but the one he speared was another man's

---

<sup>36</sup> This idea of dooming, the presence of the splinter, etc., is explained fully in Bull. 5—Sect. 114.

<sup>37</sup> *Lit.*—makes it on-the-head.

<sup>38</sup> *Lit.*—struck.

<sup>39</sup> For a description of these 'wutchi,' etc., see Bull. 5—Sect. 116.

friend.<sup>40</sup> And those who had previously attended to the corpse now leave the locality where the flesh is buried in the ground. The women dare by no means go to the spot again or walk on the same road or even drink water from this place which is now 'tabu' except to the old men. If the women did so they would be killed by the deceased's spirits: that is what they are frightened of, and so they always take another road while the men follow the usual track. After some time when the corpse becomes old, the men cut off their hair and beard out of regard to the deceased, and burn some of his property, not all, but only some. The women also cut their hair<sup>41</sup>: this done, they all lament again over the dead. But what the girls and widows now have to fear is that some one might take them, now that their hair has been cut. For when their hair is cut men can take them to wife, and the widow is claimed by the deceased's younger brother."

The trough is carried about at least until the hair is cut, and finally buried somewhere in deceased's own country, hidden in a cave, or put under the ground: it is the mother or mother's sister who carries it about. The carrying about of the remains here is locally believed to be a sign of love and affection: were the survivors not to ensure its being properly carried out, it would look as if the deceased had had no friends among the tribe.

Old men and old women, so long as they are infirm, are buried straight away without any ceremony.

6. The Bloomfield River natives<sup>42</sup> make a distinction in the final obsequies between those males who have passed their days in comparative peace and quiet and those who have rendered themselves unusually prominent.

In the case of any male who happens to have no powerful relatives, or who has never made himself conspicuous by any deeds of valour or prowess, and in the case of any female whatsoever—

<sup>40</sup> He thus confirms the guilt of the already suspected person who has been blamed, and who will sooner or later be made to pay the penalty, usually a life for a life.

<sup>41</sup> The hair so cut from the mourners is rolled tightly round a stick, and placed upon the trough enclosing the deceased. No marriages amongst the relatives of the deceased are allowed to take place until the hair-cutting takes place.

<sup>42</sup> I am indebted to Mr. R. Hislop, late of Wyalla, Bloomfield River, for much of this information.

directly such an one is dead, the body is wrapped up in a sheet of tea-tree bark, with the arms laid at the sides or crossed over the breast. It is thus kept for a few days until the relatives, for whom the messengers have been sent, can come up and view the body which is uncovered from its wrappings as occasion requires. Each night the body is mourned, the mourners covering themselves with pipe-clay or white mud—a ring of it around the women's faces in addition—and as often as not besmearing their bodies with the oily exudation from the corpse: whenever the latter custom is practised, they must not wash themselves until the stench has entirely disappeared, which it sometimes takes upwards of a couple of months to do.<sup>43</sup> In between the wailing and the crying, they will moan somewhat as follows "Oh, Brother (etc., as the case may be), how we used to go hunting the kangaroo," "how we used to" do this or that, recalling some familiar episode or adventure in connection with the deceased, "and now you have left me behind!" The body is at length buried during any time of the day, the place of burial being immaterial so long as it is away from the camping ground and remote from any particularly plentiful patch of food, because any such place of burial, and anything growing on it is 'tabu' to the women, not however to the men. The hole which is dug is about three by one-and-a-half feet at the surface, where it forms an oval, and about three feet in depth where it is larger by being made circular. While still wrapped in its bark-sheet, the corpse is doubled up both at the thighs and at the knees, coverings and all, so that the knees are in close apposition to the face, and the whole tilted in towards one or the other side: if the deceased has died away from his home he is placed in a position facing it, otherwise he is made to look towards the east. The grave is then filled up with earth, and sometimes a vertical blaze or cut of indeterminate shape is incised in the neighbouring trees.

When an aboriginal who has had plenty of friends or who has made a name for himself, at last closes his eyes in death, there is a greater amount of mourning, and steps are taken to discover the murderer who doomed him, then to punish him. Having been wrapped in bark, the corpse is laid in a trench not more than a foot deep, and covered with earth, while at the same time an ordinary black's hut is built over the site: in this hut, the chief mourners have to temporarily reside and hence its size will depend upon the number of people it has to accommodate. When all his friends, relatives, and other visitors have at last been

---

<sup>43</sup> Note that on the Pennefather River the vital principle may be connected with the sense of smell (Bull. 5 Sect. 68).

gathered together, and this may take several days, the grass-covering of the hut is removed, but the frame-work allowed to stand. Certain of the old men and the dead man's nearest relatives—and there are here reckoned to be his group-mother's or blood mother's brothers—next dig him up, lay him on the flat, and carefully examine for any bruises or marks of external violence, and consult as to those that may be accounted for, and those that may be laid at the door of some enemy. They next start removing the whole of the outer skin, commencing operations by pressing with the ball of the thumb and so peeling off the cuticle with its colouring matter and leaving behind a comparatively pale surface. Another examination is now made for any marks of violence, and of course certain bruises are invariably discovered. Then follow two vertical cuts, one on either side close to the spine, cutting through the proximal ends of the ribs and so removing the whole of the head and back-bone in one piece: a view is thus obtained from behind into the thoracic and abdominal cavities with the object of obtaining any additional confirmatory clues as to the cause of death, which are always forthcoming in the shape of a wooden splinter, spear-tip, etc. Finally, the whole of the left upper extremity, including the shoulder-blade, and left lower extremity, minus the pelvis, are removed, and together with the head and back-bone sewn up in a bark trough of the pleat-type<sup>44</sup>: this trough is taken charge of by the mother or mothers during the day, but by a blood- or group-brother at night, when it is often utilised as a pillow. On top of this pillow are placed portions of the deceased's hair which will subsequently be worked up with fibre-twine to make mourning strings. The whole of the remainder of the corpse is then either re-interred in the same hole which it had previously occupied, but now made deeper, or else occasionally cremated.

After various deliberations, the old men, relatives and friends of the deceased, come to an unanimous conclusion as to the ownership of the wooden splinter, spear-tip, etc., that is alleged to have been removed from the inside of the corpse: the ownership is practically always tacked on to some individual, resident or stranger, who happens to have no powerful friends or who may have the reputation of making himself generally objectionable all round. Of course the accused indignantly denies the charge, and argues to shew that he had always been on amicable terms with the deceased, that they had often gone out hunting together, that

---

<sup>44</sup> Bull. 7—Sect. 58, and figs. 223 and 226.



they had never had any quarrel, and finishes by trying to shift the blame on to somebody else : his efforts in this direction may prove successful or not. At any rate, some one is fixed upon, guilty or not, who recognising it to be a case of "needs must when the devil drives" offers expiation<sup>45</sup> by challenging his accusers to spear him. Two of his mother's brothers, or, if these are not handy, two of his own brothers, standing on either side are allowed to lend assistance, their weapons of defence however being only three wommeras, one apiece. The first whom the accused challenges is usually the deceased's mother's-brother, then come the brothers, friends, etc., though in the excitement of the moment some two or three will rush up to a distance of some ten or twelve yards or so, and simultaneously let fly their spears at him. The alleged culprit, notwithstanding the immense mental and physical strain, may thus, with the help of his two friends, succeed in escaping any serious effects from the thirty or forty spears which have been thrown during the good hour and more that he has exposed himself. Should he come through the ordeal successfully, and a lot depends upon his previous conduct and the influence of powerful friends, his accusers will ultimately run up and cling round his neck, indulge in a certain amount of weeping, all make friends again, and finally fix the guilt a second time, generally upon the weakest tribe and its most friendless member. In this district, some one *must* be killed for the death of every "important" male aboriginal. The bark-trough containing the remnants of the corpse is now carried about from camp to camp by one of the brothers : it is supported on his head with a pad, and may go on its peregrinations for from two to three months, a renewed wailing taking place at each fresh camping-ground. Every now and again, just about dusk, the brother with one or two friends makes a circuit of a mile or so with the remains round the camp, and so soon as they can assure themselves that they hear the bones rattle<sup>46</sup> as the package is jogged along, they know that they are in the neighbourhood of the alleged murderer. In this Bloomfield River District, the Bannabilla natives at the mouth of the river are deemed to be the weakest and most friendless, and one of this tribe is generally, as a last resource, fixed upon as the culprit : the latter is enticed away on some hunting expedition, for a corroboree, etc. and then mercilessly speared from behind. The bark-trough with its contents is not necessarily buried immediately

---

<sup>45</sup> Bull. 8—Sect. 13.

<sup>46</sup> Needless to say, these are made to rattle when the suitable opportunity offers.

after vengeance has been taken, but is often carried about until such time as one of the deceased hero's mothers, brothers, or sons happen to die. The immediate relatives do not cut their hair until all the ceremonies are completed.

<sup>7</sup> 7. Amongst the Lower Tully River<sup>47</sup> natives, friends and relatives attend upon the sick person until the last moment, and immediately after death tie him or her up with lawyer-cane, a procedure in which all assist; the tying-up position is with the flats of the hands in close apposition, either pressed closed to one side of the head, or else passed forward between the two shins



Fig. 56.



Fig. 57.

(figs. 56, 57). The body is either buried or burned, there being nothing to choose between these methods, and if cremation is fixed upon, the burning may be either immediate or subsequent; occasionally it may be desiccated. The tied-up body may be kept for two or three days before actual burying, etc., especially if the deceased had been a favourite, and portions of it may now be eaten, amongst other reasons, in order to give cause for fight and quarrel at the *Prun-ground*.<sup>48</sup> While thus awaiting burial, etc., it is not removed from the hut in which it has been placed, but is visited all night, relay upon relay of men and women indiscriminately, taking it turn about to do the howling and wailing.<sup>49</sup> In close proximity to the hut, the mourners may be seen squatting in groups, two three, or four individuals together, with arms around each other's neck or shoulders, heads all turned down and towards each other, bodies swaying from side to side, and all bemoaning and crying.

<sup>47</sup> Mr. E. Brook, Junr. very kindly acted as interpreter for me here.

<sup>48</sup> Bull. 4—Sect. 15.

<sup>49</sup> The blacks here are in no sense frightened at the presence of a corpse: it is the spirit, etc., after the burial or cremation that they have a dread of.

At intervals they go to view the corpse, and "kiss" it with a blowing sound on the forehead or cheek. The body is usually carried from the hut to its ultimate destination on a man's head, and the hut subsequently burnt or otherwise destroyed: it may however be slung lengthwise on a pole and so borne between two men. The place of burial or cremation is never out in the open plain, always in some shady spot on the edge of the river-bank or dense scrub. There would appear to be no special burial ornaments, though as signs of love and affection in order to keep the deceased in remembrance<sup>50</sup>—not necessarily by implication as signs of mourning—there are a few facts to be noted. Thus, after any cremation, the female relatives, generally the neices on either side, look out for the teeth and wear them after the manner of a forehead fringe, each tooth attached by a blob of wax to tufts of the frontal hair. If a child dies at or soon after birth, the navel-string is cut off and worn as a necklace by the mother.<sup>51</sup>

With ground-burial, the body, having been tied up in position as already described, is ready for the grave. This may be shallow and longitudinal, or vertical and deep: in the former case, the corpse is always laid on its side, with the head in any direction, whereas in the latter it is put down feet first, *i.e.* in a sitting posture, the whole being then filled in with earth and built up a bit, with bushes and grass placed on top. The bones, whether of males or females, may subsequently be removed from these graves, painted with red ochre and so carried about in the dilly-bag by the friends and relatives who every now and again may be seen crying and wailing over them. Thus in one of the local camps I observed three or four people squatting in a circle and wailing over the bones lying in their midst, talking as it were to the skull strung on a twine which was handed in turn from one to the other; they expressed themselves somewhat as follows—"How we miss you!", "We used often to hunt together," "We remember when Koi<sup>52</sup> went away," etc.

Cremation is accompanied with ceremonial only when the social status of the deceased warrants it. With any ordinary mortal the body in the tied position is carried on the bearer's head and thrown on to a specially prepared pyre, from out of the ashes of

---

<sup>50</sup> This is the nearest translation that could be made of the sentiment which the natives themselves described to me.

<sup>51</sup> In the Atherton Scrub, I have seen a mother thus wearing the heart of her dead infant.

<sup>52</sup> Bull. 5—Sect. 65.

which the female relatives may subsequently pick some of the calcined bones, teeth, etc., as already mentioned, though this practice is not an essential. The cremation may take place during any part of the day. The deceased's bark blanket and personal knick-knacks being burnt at the same time, though as a rule, the latter, especially his necklet, will go to the widow: his fighting weapons become the property of his younger brothers. In the case of certain "virile," specially distinguished and respected men, some very complicated customs are associated with their cremation, as follows. To start with, a corpse under such circumstances is



Fig. 58.

not tied up, but kept for some days until well swollen up, when it is carried down to the water where all its outer skin and hair is washed and rubbed off, and its hands tied together. The site for its ultimate cremation having been selected, one of the old men, chosen for the occasion, carries the corpse over his shoulders, like a "pick-a-back" baby, its legs dangling over his chest, its arms fixed by its tied hands over his forehead, and its head swaying from side to side (fig. 58), it is thus born in front of the procession, men and women advancing in indian file, but all silent. On arrival at the spot chosen (fig. 59), the body is placed on the ground and made to assume the squatting position (fig. 59c), propped up against the butt of a tree, and there it remains watching all the subsequent proceedings until late in the afternoon.<sup>58</sup> In the meantime,

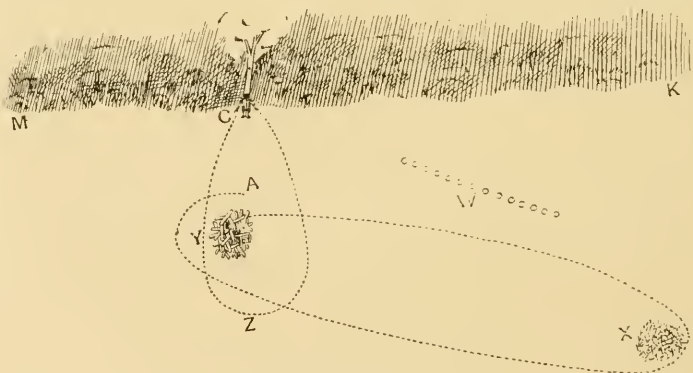

Fig. 59.

<sup>58</sup> The natives informed me that the body was purposely so placed so that it could see everything.

those who had followed it to its present resting place commence collecting firewood, the men gathering big pieces of timber, and the women little ones: the larger sticks are placed on the spot where ultimately required for the cremation (fig. 59y) while the smaller ones are gathered together in a heap about twenty yards distant (fig. 59x). The women now take themselves to the left hand side of the corpse and squat side by side all in one straight row (fig. 59w): their business is to cry, to strike their forks<sup>54</sup> and assist in the singing. The men collect together close to the heap of bigger faggots, between it and the dead body (fig. 59a), and advance in indian file behind the same old gentleman who carried the corpse to its present resting place, and who now marches at the head of the procession: it is he who leads the song in which the others join, but he alone keeps the time with the sounding-sticks<sup>55</sup>, stamping his foot at each beat as he slowly comes forward, the others following and keeping exact step with him. The song which is sung over and over again all the way, and while the sticks are sounded is—"Yakai! ngaja winjiri winje ngenuna chainban, kuna pundili warre-marigo."<sup>56</sup> The route taken is towards and around the pile of smaller sticks, and as each individual passes it he picks up a twig with his left foot, and hopping on his right, to the beating of the time gets back to whence he started, the circuit enclosing the two heaps of faggots being completed: each now takes the twig from his left foot with his hand, and places it on top of the pile of big timber. Collecting again at the same spot, another start is made, the same performance gone through, and circuit after circuit completed until the whole heap of smaller sticks is removed by foot. I was informed that if the men were to touch with their hands any of the small bits of wood, before arriving at where the big faggots are heaped, they would get sores on their hands, and what is more important, the timber would not burn properly when lighted. The second heap having been thus cleared away, the old corpse bearer accompanied by the men walks close up to the dead body, upon which they next all turn their backs and retire to a spot about thirty feet distant. They all now re-approach the body simultaneously in rows of twos or threes, one solitary gin, not necessarily a relative, bringing up the rear, and all of them singing and repeating the song already mentioned.

<sup>54</sup> Bull. 4—Sect. 29 (*e*).

<sup>55</sup> Bull. 4—Sect. 29 (*f*).

<sup>56</sup> *Lit.* = "Alas! I wonder where he (*i.e.* Koi, Bull. 5—Sect. 65) met you! We will take your guts out and see."

The men do not come forward in ordinary walking gait, but each has his hands on his hips, thighs separated, with an inward movement of the knees at each advancing jerk of the body all done to the time kept by the old gentleman's sounding-sticks, and the old woman's clapping of the flats of the hands held well in front of her. This procession may thus advance and retire in broken order, some two or three times. The same old man as before now carries the corpse in the manner already described, and, in company with three or four of the men and the gin, makes the circuit of the timber-heap a few times (fig. 59z), and then drops his burden at the same tree-butt that he started from. Finally, the corpse is removed to a spot on the further side of the edge of the scrub (fig. 59m), three men only accompanying its bearer, the other males having joined the row of women with whom they are now squatting, the females alone beating time to the singing of the same old song. Having reached its new destination, the corpse is laid on its back, and awaits the setting of the sun. As soon as this is half way over the horizon, another old individual, usually a Kobi, or "medicine-man," sits astride the dead body, towards its head, and makes the following incisions: one, right across the top of the belly, and one down each extremity of that incision, so as to allow of the flap of skin being turned downwards. He removes the stomach only, wraps it up in the deceased's bark-blanket, and holding it in front of him crouches along as he makes his next move to the near side of the edge of the scrub right in front, and in close view of the group of assembled men and women squatting in their original places (fig. 59k). I use the term "crouches" purposely, because, as the old man passes along, he looks suspiciously on either side and over his shoulders, as if he were being watched by, or was watching for, something of which he was terribly afraid. The interpretation of such action on his part is that Koi<sup>37</sup> might come and do to him what he has done to the deceased, *i.e.*, taken the vital principle, breath, etc. away: he accordingly keeps watching to see that his three companions are closely following, because this spirit can only harm him when alone by himself. All four move along in quick time, stamping in step to the sounding-sticks which his three companions carry, and as soon as the spot fixed upon is reached, the bundle is placed on the ground and the old man left alone with it. No one actually sees what he next does, but it is firmly believed that he cuts open the paunch and finds the "rope," "something,"

---

<sup>37</sup> Bull. 5 Sect. 65, 116.

etc.<sup>58</sup> that the deceased has been doomed with, and which he buries separately to prevent its returning and giving the tribe trouble. He is thus able to understand the cause of death and to discover the guilty party. After the burial of this "something," etc. he rejoins the others and all now proceed to the corpse over which they have a good cry, it being finally carried by the same old man who did the post-mortem on to the funeral pyre, already lighted, and there left to be consumed. And while the fire burns, the widow will advance along the edge of the scrub in the direction of where the sun has just set, waving bushes which she holds in front of her, and sweeping them outwards: with her feet she takes a side-step or two alternately to left and right, the gentle swaying of her limbs and body constituting a most graceful and pleasing movement. With the sweeping of the bushes, she is supposed to drive away the Koi of her late husband. At the next Prun<sup>59</sup>, the guilty party is charged with the offence, and has to answer for it in the usual manner. Dessication is a form of disposal of the dead practised only in the case of very distinguished males, indeed for such as would be considered worthy of cremation with ceremonial: after being disembowelled and dried by fire on a grid or platform, the corpse is tied up and carried about for months.

8. On the Russell River, this desiccation process appears to be highly developed, the "mummy" being ornamented (Pls. lxxi., lxxii.).

9. In the Boulia District<sup>60</sup> when an individual, male or female, dies, some bushes are heaped over a net spread out upon the ground, and on these the extended body is laid, the arms lying at the sides or down the front. Generally with a spear, the net is fixed lengthways above, so as to enclose the corpse in a sort of net-sheet. Two or three men, side by side, carry the body resting crossways on their heads, the whole of the camp accompanying them to the burial place. A grave having been dug, the body is laid in horizontally, face up, with the head pointing to the north, which is considered the orthodox position: the depth of the grave

<sup>58</sup> Bull. 5—Sect. 114.

<sup>59</sup> Bull. 4—Sect. 15.

<sup>60</sup> The account of the disposal of the dead in the Boulia, Cloncurry, and Upper Georgina Districts is extracted and revised from my "Ethnological Studies," etc., published in 1897; comparatively very few natives are now to be met with in these areas, those that survive being more or less contaminated with civilisation.

appears to vary with the nature of the soil, but about four feet is the average, though this is often exceeded. The corpse is next covered with logs placed longitudinally, then with a layer placed transversely, to be followed with a filling in of earth and soil : on top of all this are placed heavy logs and bushes, perhaps some heavy stones, all closely interlaced, and reaching to a height of from three to four feet above the adjacent surface which is cleared to a distance of a few feet all the way round.<sup>61</sup> The boomerangs, spears, etc. belonging to the deceased are either buried with him, destroyed by fire, or more rarely distributed amongst his brothers while his name ceases to be mentioned. Burial follows almost immediately upon death taking place though if the closing scene occurs at night it is not carried out until early dawn. The corpse is in no ways decorated or painted. At the grave, and while it is being dug, in the midst of the weeping and the wailing, the woman will cut themselves with stone or glass down the outer and anterior aspects of the thighs, in numerous more or less parallel superficial incisions : previous to the cutting, and possibly with the idea of making the wound all the more painful, the Glenormiston women have been known to wash their thighs with their urine. These signs of mourning with the females have their counterpart among certain of the male relatives at Carlo, Glenormiston, Herbert Downs, and Roxburg Downs, but apparently not at Boulia, who make a single large and much deeper crucial incision on the corresponding portion of the thigh. The actual burial being completed, all return with many a sob and tear to the camp where they plaster their heads with blobs of "parta" (PPT), or gypsum, causing the whole head of hair at a distance to appear one mass of white (Pl. lxxiii., fig. 1) : owing to such fixing-up with this material, a mourner is spoken of as "parta-maró," *i.e.* plaster-possessor. In any camp uncontaminated and away from the settlements, this plastering is adopted by all, whether the deceased be man, woman or child, though it is worn longer by the nearer relatives, *i.e.* the widow or widower, blood-brothers and -sisters. It is these nearer relatives, and they only, who in addition, colour-grease themselves down as far as the waist, both back and front, with red and yellow ochre in patterns varying with the sexes, and wear an opossum-string armet : in the case of a young child deceased, no painting would be adopted by anyone. Exclusive of the nearer relatives, in addition to the gypsum, or more usually

---

<sup>61</sup> In the Pitta Pitta language of Boulia, a grave is called mur-ra Kambo (=stick stone).



when its supply runs short, greased ashes or mud by itself may be smeared over the whole body as external emblems of grief. Crying and weeping is repeated nightly for a week or two, especially by the nearer relatives who may repair to the grave for the purpose, the sisters continuing when the brothers cease; they generally go in parties being afraid to go singly on account of the deceased's ghost, spirit, etc. Food, pituri, tobacco, etc., may be left regularly at the graveside, and the corpse openly informed to that effect. If the individual who doomed, pointed the bone, etc.,<sup>62</sup> at the deceased has been recognised before the death took place, his identity would be confirmed, or otherwise discovered here by the tracks from the spirit, etc., at the grave. When an individual has been killed by the whole tribe collectively, *i.e.*, in punishment for some serious crime, he is usually made to dig his own grave, which is subsequently closed in similar manner except that the boomerangs, etc., with which he has been done to death are substituted for the long logs immediately covering the corpse; when, as in cases of murder, the assassin has been caught red-handed, the slayer and slain are buried together in the same grave previously dug by the survivor. In time of open hostilities, those who are killed are left on the field by their enemies, with broken spear or boomerang close beside to show the passing wayfarer how the individuals in question met their death.

10. In the Cloncurry District among the Maitakudi, the corpse is usually buried in a crouching position with head down, enclosed in a net perhaps, then covered with some tea-tree bark, and the earth thrown on top: no logs or sticks are piled up above, but the ground is smoothed to the level of the surrounding surface and a more or less circular area cleaned up. When night falls, a fire is lighted at a few yards distant from the grave, and some meat, etc., hung up on a neighbouring tree: this may be repeated for three or four nights following, and occasionally now and again during the next few months, until it is believed that the deceased "has got too old, has gone away somewhere else." In the olden days the women used to wear the gypsum as a sign of mourning, but nowadays both sexes only besmear themselves with mud, or else paint themselves red as far down as the waist; incisions used also to be made along the fronts of the thighs, several small superficial ones on the women, and two or three deep ones on the men. Where no visible or otherwise intelligible cause of death presents itself, one of the medicine-men will find out whether this

---

<sup>62</sup> Bull. 5—Sect. 144.

is due to Malkari,<sup>63</sup> or his counterpart, who in this country, is believed to kill blacks, or to some human enemy with the mangai<sup>64</sup>: in the latter case he would make believe that he had picked up the particular incriminating gew-gaw in the neighbourhood of the grave, and accuse some individual of having committed the crime. In other cases, the near relatives of the deceased may learn something for themselves by sticking upright a small forked stick on the grave itself, and placing on it a manda-kuya<sup>65</sup>; this is done at night, and if on the following morning this amulet has fallen down, it is proof positive that the late lamented has met his death at the hands of an enemy "from a long way country."

11. In the Upper Georgina District, along the river from Cavandotta upwards, tree-burial is practised. A sort of platform of logs is built in the tree about ten or twelve feet from the ground, and upon this, wrapped in its net, etc., the corpse is laid: various sticks and bushes are placed on top, and in and among them the deceased's possessions may be enclosed. The body is usually laid with the head in the direction of the north or north-east. Among the Yaro-inga, between Urandungie and Headingley, I was informed by members of the tribe that, in the special cases of important personages, when all the flesh is rotted off, the bones may be removed and buried in the ground, with nothing on the surface to indicate their presence beneath. In the neighbourhood of Camoowal, I have seen the body of a dog buried up in a tree in exactly the same manner as a human corpse. Gypsum in this district is also used as a sign of mourning: the same material prevails also in the Leichhardt-Selwyn District, though the Kal-kaduns use red and yellow paint in addition.

12. To return to the eastern coast-line, when any ordinary adult male died at Torilla or Pine Mountain<sup>66</sup>, his big toes as well as his legs were bound together. His wife and blood-relatives stayed in camp where they moaned and wept, cutting their heads with tomahawks and beating themselves with sticks and shields, while other blacks would remove the corpse to a spot about half a mile away, dig a shallow grave, and scatter the excavated soil to a distance of a few feet all the way round. The body was next laid in the grave and covered over with logs, sticks, etc., but no soil, that which was excavated being carefully smoothed over.

---

<sup>63</sup> Bull. 5—Sect. 118.

<sup>64</sup> Bull. 5—Sect. 144.

<sup>65</sup> Bull. 5—Sect. 154.

<sup>66</sup> Information given by Mr. W. H. Flowers, late of Torilla.

Next morning, this smooth loose soil round the grave would be carefully examined for any tracks, for it was firmly believed that the individual who had murdered or otherwise doomed the deceased would be certain to visit the victim's place of burial, and so be identified. Three or four days later portions of the flesh would be cut away and put into small dilly-bags, which were together tied up in a bundle and carried about by the widow or mother for months, from six to twelve, until such time as the bones were disinterred, when they were all passed through a more or less triangular aperture cut in a hollow tree. If the deceased had been a great warrior, his body, previous to the ground-burial, would be placed on a stage about six feet high for some few days' during which period the young men would go underneath to collect the drippings which would then be carefully rubbed into their skins: occasionally the kidney fat would be removed and used in similar fashion. With women, no trouble appears to have been taken: they were just wrapped in bark, put in a shallow grave lined below with long saplings, covered with earth, saplings again, and left there. When little children died, their bodies were kept whole in camp until tree-buried. Mourning was in all cases maintained until the final tree-burial, and in the case of a married man's death, the widow had to remain in camp throughout all this period, only after which was she allowed to re-marry. With very slight variations, the description of the disposal of the dead at Torilla and Pine Mountain holds good for the whole coastline from the neighbourhood of Mackay to Broadsound, Rockhampton, including the Keppel Islands, down to certainly Miriam Vale, though naturally such practices with closer European settlement, etc., are rapidly dying out if not already extinct. Throughout the tract of country under consideration, I had several opportunities during 1897 of examining the empty graves as well as the bones, almost invariably male adult, hidden in the neighbouring trees. The apertures in these hollow butts—more or less mitre-form, though with age and growth of the bark they become rather oval (Pl. lxxiv.)—are from twelve to twenty-two inches long by five to seven inches wide, cut at a height of from four to six feet from the ground, and closed from within either with grass, sticks, or bark: they are said to have been painted around in red and white, zig-zag fashion. At that time also I heard frequent mention of the scaffoldings that had been noticed at Yeppoon, Mt. Hedlow, and elsewhere, but which even then were things of the past. At Miriam Vale<sup>67</sup> the platform was formed of a few sheets of bark

<sup>67</sup> The description of the burial ceremony here was given me by the late Mr. E. C. Roe.

resting on cross-pieces supported on the forked extremities of posts some ten or twelve feet high fixed firmly into the ground. The corpse previously stabbed in the loins, from which the putrid matter subsequently trickled out, was laid upon this platform face upwards : it swelled a good deal for the next few days but soon became sun-dried, and was then left totally exposed for from three to five months according to the state of the season. Without any intermediate ground-burial, it would now be taken down and squeezed head foremost through the aperture cut for it in the hollow tree chosen. Previous to the exposure on the platform, the hands and feet of the deceased would occasionally be eaten, and especially would this be the case with one killed in tribal warfare. Females used to be ground-buried straight away after death, and left there, though now and again a woman's corpse, wrapped up in bark, would be seen carried around for months from camp to camp, though with what object is now unknown.

At Rockhampton and at Broadsound, when an infant died, the mother would tie up one or both of the dried tiny hands in a dilly-bag and carry it about with her long after the burial had taken place. On the Keppel Islands<sup>68</sup> in addition to tree-butt burial, rock-shelter graves were employed, the front lower edges of such shelters being ledged in with small pieces of rock. In one of such caves, on North Keppel, well-hidden from cursory observation by growing brush-wood, in a space about four and a half feet wide, and three feet from front to back, I found the closely packed remains of at least eight adults and two infants : the latter were enveloped in bark contained each within a dilly-bag, while the bones of the adults, except the crania and maxillæ, which had been left exposed and separate, were wrapped up in a fishing-net. Scattered here and there among the debris and sand were dolls<sup>69</sup>. On this same North Island I also came across a dilly-bag, containing the remains of a piccaninny wrapped up in bark, hung up with twine from a tree branch. Some of the inhabitants of the smaller islands about Broadsound are said<sup>70</sup> to have taken their dead out to sea in a canoe and thrown them over-board.

13. Amongst the Brisbane District blacks, variations in burial customs<sup>71</sup> depended upon whether the deceased were adults or

---

<sup>68</sup> Now (1906) devoid of natives.

<sup>69</sup> Bull. 4—Sect. 11 (*b*).

<sup>70</sup> On the authority of Mr. W. H. Flowers, late of Torilla.

<sup>71</sup> The above particulars were taken down between 1900 and 1902 in the course of conversations with Mr. Tom Petrie. There is now no survivor of the Brisbane blacks.

children, male or female, deformed or not, etc. Wherever a black died or was eaten, the trees in close proximity were nicked around.

In the case of adults, immediately after death, some old "medicine man" not necessarily a relative would cut off the whole genitalia if a male, the clitoris only if a female, wrap them up in grass and place them high up in the fork of a tree: this was signficatory of the sexual instinct being finished with, and to prevent the spirit (nguru) of the dead entering into sexual relations with the living. The next process depended upon whether the corpse was to be eaten or not: it was eaten if deceased was a well-known warrior, a medicine-man, a man or woman killed in fight, or a woman dying suddenly in good condition.

If determined on eating the body, it was immediately carried, legs foremost, on the shoulders of two or three old men to a distance of half or three-quarters of a mile from the camp, which was thereupon shifted, the men, women and children following. When a big fire had been made, the body was laid face downwards on a large sheet of tea-tree bark lying alongside. The others squatted in groups in a circle all round the deceased, a few yards distant, each with its own fire. One "medicine-man" now took the sap-wood of an old tree, a piece about a foot long and three or four inches wide, got it well lighted, removed the burning cinders, and while still glowing, applied it all over the corpse, except the head, thus singeing off every vestige of hair (except of course that of the scalp hair and beard) and causing the flesh to turn a kind of light brown colour; he then rubbed the whole body over with his hand, thus removing all the burnt shreds of outer skin and hair particles. Standing about one hundred yards away were three other "doctors" each holding a stone knife in his mouth: one of them would advance singing, the knife now held in his hand, pass through the circle of scattered groups, and reach the corpse. If the corpse was that of a male, it lay on its stomach. The newcomer after making a median incision right through the skin from top of the head, along the neck, right down the middle of the back as far as the anus, would then retire to join the groups around; the second "medicine-man" would advance in similar fashion and incise, from the median cut just made, across the shoulders down the middle of the backs of the arm, fore-arm, and hand as far as the knuckles, and similarly retire; he would be succeeded by the third doctor who cut from the extremity of the median incision, down along the middle of the buttock, and back of each thigh, leg, and heel. If the corpse was that of a female, it lay on its back, the three incisions being correspondingly made on the front: median, from the top of the head right through the middle of the nose and face, down the

neck, chest, and belly as far as the fork : the second, from the neck down to the fronts of the upper extremities as far as the tips of the palms : the third, from the fork down the fronts of the thighs and legs as far as the insteps. Two of the doctors next commenced to get off the skin along these incisions, removing it in one piece with attached toes, fingers, ears, etc., and then to stick it up on spears to dry before the fire. The body after its entrails, heart and lungs had been removed, was next cut up by the doctors and carefully disjointed, its different portions being indiscriminately shared by themselves and the people around among whom they were thrown.

The old and young alike of both sexes partook of it after roasting, the pelvis, skull, jaw and bones of both limbs being previously removed from the portions so distributed, and put aside : it was only the back-bone together with the ribs and attached meat that were thrown into the fire and so destroyed. The sentiment which prompted this eating of the deceased was a double one : the survivors knew where the dead actually were and so could not be frightened by their spirits, while the disposal of the corpse in this manner prevented its going bad and stinking. The liver was eaten, but the entrails, heart and lungs buried, the spot being marked by three sticks about a foot high, each wound round with grass-rope, and stuck closely apposed into the ground. When the bones, which had been put aside, had been cleaned of all their flesh and brought by the deceased's mother, widow or sister (in order of preference) back to camp, one of these women would take the whole pelvis,<sup>72</sup> put it on a log, and start striking it with a sharp tomahawk-stone, taking care that when a crack should at last be heard, the name of some individual in particular<sup>73</sup> should be mentioned. She would then recommence the hammering, so arranging matters that when the crack again took place, the same name would be repeated. And the old men would say "Ku-ré ! Ku-ré !",<sup>74</sup> and thus accept the proof that the person mentioned was actually the one implicated : so much so, that when met with, the latter would be put to death, usually by sneaking upon him at night-time. After the deceased's skin had been thoroughly dried, it was covered with charcoal and grease, folded up and carried, together with the bones in a dilly-bag by the mother, widow or sister, who would cry over it for some ten minutes or so regularly at night and

---

<sup>72</sup> A thigh-bone was struck to similar purpose.

<sup>73</sup> This was usually some member of another tribe on whom they had a special "down."

<sup>74</sup> An expression of astonishment, wonder

at early day break. Portions of it, *e.g.*, chest and back where the scars were, were given to the women friends of another tribe, who when they got back to their camps, would start another crying match over them on their own account. This giving of the skins to women of another tribe denoted that these women's husbands and their friends were not considered the guilty parties: it was a sort of confidential tip that they were not suspected and might in perfect safety come to visit the tribesmen of the person deceased.<sup>75</sup> After the remaining skin, with the bones, had been carried about by the women already particularised, for some two or three months, or until such time as another corpse had to be similarly treated, the dilly-bag was finally slung up on top of a forked stick stuck upright within a hollow tree.<sup>76</sup> Several of such bags might be placed in the same tree which was considered "dimaggali," *i.e.* tabu.

Tree-burial without eating was the method of disposal in the case of any ordinary male mortals, and all women except those killed in fight or who had died suddenly in good condition. After removal of the genitalia as before mentioned, the body was wrapped round in a sheet of bark, tied tightly round beyond the head, and bound carefully round and round with wattle-bark, only

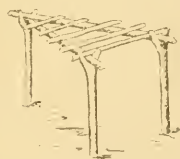

Fig. 60.

the tips of the toes being left exposed. It was carried feet-foremost on the shoulders of two men to some gully or out-of-the-way place in which they never hunted (if on the coast, to one of the mangrove islands) where a tree with suitable fork, *i.e.* six or seven feet off the ground, was chosen. Two forked sticks were next cut and fixed upright about seven feet from the tree, and a platform erected (fig. 60), but in such a way that when the body was resting on it, with head next the tree, the feet were always towards the west. Under this platform a circular space of about four feet diameter was cleared, and here a small fire was made, with the deceased's spear and waddy (if a male) or digging-stick (if a female) stuck in the ground: the deceased's spirit was thus enabled to go about and hunt at night, and also cook his or her

<sup>75</sup> This explained how Mr. Tom Petrie was received so well by tribes beyond the Turrbal boundaries, when they knew that he had been given portions of the skin of Yabba's son, a well known and respected Brisbane character.

<sup>76</sup> In neighbouring tribes, a shelter-cave now and again replaced the hollow tree.

food. Next day, two of the old women—mother, widow, or sister—would go out to the resting place, recognise the imprint of a human foot<sup>77</sup> close to the fire, arrange between themselves to fix the guilt on a darkie of another tribe whose foot-print they would declare it to be, and, returning to camp, spread the information thus obtained. During the crying at night and at daybreak the alleged culprit would be cursed and sworn at by the relatives and friends with such epithets as “big head,” “big belly,” “crooked leg,” etc., and threatened with what would be done to him when caught. Two or three months later, when the body had rotted, it was taken down by two of the old women, opened out, the skull, jaw, pelvis and limb-bones cleaned up and rubbed with charcoal, while the remainder of the corpse, including the bones of the toes, fingers, ribs, and back-bone, was burnt. Having brought the bones in a dilly-bag back to camp, a fire was made at about one hundred yards distant, and hither the whole company present, including the two women, proceeded. The mother, widow, or sister of the deceased then started hammering away at the pelvis, etc., as before, making it crack when mentioning the name of the person whose foot-print had been originally detected, and thus confirming the evidence of accused’s guilt, the latter being accordingly put to death at first opportunity.

Deformed people, after their demise, were just pushed and jambed naked into a hollow log, no more trouble being taken over them.

The bodies of young boys and girls were never skinned or mutilated, but usually put up on the tree-platforms unless they died suddenly and in good condition when they might be eaten by men and women, the entrails, etc., being cut away and buried under three sticks as already described. The corpse of a very young child was roasted whole, and eaten by old women only. New born babies might be killed and eaten, only by the old women, immediately after birth, especially if this process had given the mother much pain or trouble: it was usually the midwife who screwed the infant’s neck round, breaking it by holding the jaw and back of the head between the two hands and so twisting it round. Similarly, if the mother died in child-birth, the child was deemed guilty of having killed the mother, and was invariably immediately killed and eaten by the old women.

---

<sup>77</sup> Purposely made by some old scoundrel of a “medicine-man” the night before.



The mourning was either relative to mutilations or to decorations. Men, old and young, jabbed their heads with points of the spears or with tomahawks until the blood flowed: the older men were always keener on this. Similarly, the old women banged and cut their heads with the digging-sticks: the young ones would cut the whole front of the thighs in parallel lines of small incisions with pieces of broken flint or sharp shell.

Red was the essential colour of mourning. In the case of the old men, the entire back, front, limbs and face were covered with this, relieved here and there with a splash of pipe-clay, but none on the face. The old women were similarly painted, but with more splashes of white which was also specially dabbed on the face. Feathers (swan's, etc.) tied up into bunches and covered with raddle, were fixed with beeswax into the hair of old women only. The immediate relatives and near friends would keep these decorations on for perhaps two or three months, whereas the others would drop them after a few days. The young men and young women would never wear the red paint or feathers as signs of mourning. No eulogy of the deceased took place, neither was his name mentioned.

MINERALOGICAL NOTES: No. V.—CASSITERITE  
CERUSSITE, ZEOLITES AND OTHER AUSTRALIAN  
MINERALS.

By C. ANDERSON, M.A., B.Sc., Mineralogist.

(Plates lxxv.-lxxx.).

CASSITERITE.

EMMAVILLE, NEW SOUTH WALES.

(Plate lxxv., fig. 1).

The crystal of cassiterite from this locality here figured is of interest as having an acute pyramidal habit through predominance of the di-tetragonal pyramid  $z$  (321); it resembles the needle or sparable tin of the Cornish miner, a type which seems very rare in Australian cassiterite. The prism faces are strongly striated owing to oscillatory combination between  $m$  (110) and  $r$  (230),  $r$  however being subordinate. The crystal measures  $1.25 \times .75$  cm. The part bounded by the prism faces is mainly black with patches of semi-transparent "ruby tin," the apex of the crystal down to the faint line traversing the faces of  $z$ , a little below and parallel to its intersections with  $s$ , is black with metallic lustre, while the central part is reddish and opaque. From this curious distribution of colour the probable history of the crystal may be deduced. Thus it may be inferred that it was at first prismatic in habit, most likely terminated by  $s$  (111), and of a black colour. With a change in composition (indicated by the change in colour) the prism ceased growing and the pyramid  $z$  predominated; finally came another change in composition at a time when the crystal had assumed nearly its present habit.

## ELSMORE, NEW SOUTH WALES.

(Plate lxxv., figs. 2, 3).

Fine crystals of tinstone are found at Elsmore, where they occur disseminated through greisen; weathering sets free the crystals which become concentrated into alluvial deposits of economic importance. A large proportion of the crystals are reddish, forming the so-called ruby tin. The usual habit is stout prismatic, and the crystals seem to be invariably twinned on  $e$  (101), the usual law; doublets are comparatively rare and some of the crystals are very complex. Fivelings in which a large individual supports on each  $e$  face a smaller crystal in twin position are abundant, and specimens showing the nine individuals composing a complete twin crystal of this type are by no means uncommon.

In Pl. lxxv., fig. 2, is represented according to its actual development a doublet of  $.75 \times .5$  cm. in which the two portions are about equal in size and development and the line of junction is barely visible. Unfortunately this beautiful crystal is fractured on one side where it was attached to the matrix. It is essentially similar to the crystal figured by Becke,<sup>1</sup> which however has no  $z$  planes. The forms determined and the mean co-ordinate angles are tabulated below:

Forms.		Measured.		Calculated		Error.	
		$\phi$	$\rho$	$\phi$	$\rho$	$\phi$	$\rho$
$u$	100	0 3	89 57	0 0	90 0	3	3
$m$	110	44 57	90 0	45 0	90 0	3	0
$r$	230	33 43	90 0	33 41	90 0	2	0
$h$	120	26 38	90 0	26 34	90 0	4	0
$s$	111	44 51	43 35	45 0	43 33	9	2
$z$	231	33 31	67 36	33 41	67 35	10	1
$a$	100	0 15	22 12	0 0	22 12	15	0

<sup>1</sup> Becke—Min. Mitth., Heft 3, 1877, pl. i., f. 5.

A more complicated twin is drawn (Pl. lxxv., fig. 3) in orthographic projection: here we have a relatively large crystal with four smaller individuals twinned to the former on (101). As the four smaller crystals are essentially similar the group has been idealised in the drawing. The lower surface consists of the *s* faces of the main crystal and one very small individual in twin position. The colour is black and the faces are as a rule smooth and brilliant, yielding excellent reflections. The dimensions are approximately .75 cm. (parallel to vertical axis)  $\times$  1.00 cm.

The measured and calculated angles are given below:

Forms.		Measured.		Calculated.		Error.	
		$\phi$	$\rho$	$\phi$	$\rho$	$\phi$	$\rho$
<i>a</i>	100	0 4	89 56	0 0	90 0	4	4
<i>m</i>	110	45 7	89 58	45 0	90 0	7	2
<i>r</i>	230	33 33	89 57	33 41	90 0	8	3
<i>h</i>	120	26 33	89 56	26 34	90 0	1	4
<i>s</i>	111	45 16	43 18	45 0	43 33	16	15
<i>z</i>	231	33 37	67 38	33 41	67 35	4	3
<i>a</i>	100	0 5	22 11	0 0	22 12	5	1

#### HOGUE'S CREEK, NEAR DUNDEE, NEW SOUTH WALES.

(Plate lxxv., fig. 6).

Hogue's Creek furnishes good tinstone crystals with the usual stout prismatic habit, sometimes simple, sometimes twinned: a fine example of a simple crystal yielding the forms *a*, *m*, *r*, *h*, *s*, *z*, is here figured. The faces of *r* are narrow, the pyramid *s* is large and striated parallel to its intersections with *e*. Dimensions approximately 1  $\times$  1 cm.

#### THE GLEN, NEW ENGLAND, NEW SOUTH WALES.

(Plate lxxv., fig. 5).

A rather large crystal, about 3  $\times$  2.5 cm., from this locality

presents a form different from those described above ; it is a fourling on the common law, two segments being about equal in size, the other two much smaller.

## STANTHORPE, QUEENSLAND.

(Plate lxxv., fig. 4).

The figure is drawn from one of several small crystals partly embedded in a decomposed rock of indeterminate nature carrying crystals of quartz. It measures only 2 mm. approximately in length, but its faces are bright and the signals good. It is twinned on *c*.

The following forms and measurements were obtained :

Forms.		Measured.		Calculated.		Error.	
		$\phi$	$\rho$	$\phi$	$\rho$	$\phi$	$\rho$
		o	'	o	'	'	'
<i>a</i>	100	0	0	90	2	0	2
<i>m</i>	110	45	0	90	0	0	0
<i>r</i>	230	33	37	89	59	33	41
<i>h</i>	120	26	35	90	1	26	34
<i>s</i>	111	44	55	43	27	45	0
<i>z</i>	231	33	44	67	38	43	33
<i>a</i>	100	0	13	22	17	0	0
—						22	12
						13	5

## CERUSSITE.

## BROKEN HILL, NEW SOUTH WALES.

(Plate lxxvi., figs. 1, 2, 3 ; Plate lxxvii., figs. 1, 2, 3).

The mines of Broken Hill have yielded some magnificent examples of crystallised cerussite ; the form and appearance is so characteristic that Broken Hill cerussite can generally be recognised at a glance. It occurs as long prismatic crystals, often coated with rounded, tapering crystals of smithsonite (carbonate of zinc), or again covered with brilliant anglesite. Frequently it

is found in reticulated masses, forming very attractive specimens. Very typical are arrow-head twins on  $r$  (130), sometimes opaque white and of considerable size, at other times transparent, when they are as a rule smaller. Twinning on  $m$  (110), the more usual law, I have not observed, but Mügge<sup>2</sup> and Spencer<sup>3</sup> mention its occurrence.

Simple crystals are not common; one such is represented in Pl. lxxvi., figs. 1, 2. It is tabular on  $b$  which is striated parallel to prism and brachydome edges;  $r$  oscillates slightly with  $b$ .

It yielded the following forms and angles:

Forms.		Measured.		Calculated.		Error.	
		$\phi$	$\rho$	$\phi$	$\rho$	$\phi$	$\rho$
$b$	010	0 1	89 55	0 0	90 0	1	5
$r$	130	28 37	89 57	28 39	90 0	2	3
$e$	012	0 2	20 4	0 0	19 52	2	12
$k$	011	0 1	35 51	„	35 52	1	1
$i$	021	0 2	55 21	„	55 20	2	1
$v$	031	0 2	65 6	„	65 15	2	9
$z$	041	0 2	70 59	„	70 55	2	4
$u$	051	0 1	74 55	„	74 32	1	23
$y$	102	89 56	30 40	90 0	30 39	4	1
$s$	121	39 26	61 42	39 20	61 51	6	9
$p$	111	58 37	54 14	58 37	54 14	0	0
$o$	112	58 21	34 48	„	34 46	16	2

When twinned on  $r$  and long prismatic in habit the crystals resemble Pl. lxxvi., fig. 3; if the prisms are short vertically with predominant  $r$ , and the faces of the domes  $k$  and  $\bar{k}$  meet in an edge, above, below, and at the sides, the resemblance to an arrow-head is very striking. A typical twin of this form is shown in Pl. lxxvii., figs. 1, 2; here the notch is formed by  $r$  in oscillatory combination with  $m$ , and the edges are replaced by  $r$  oscillating with  $b$ .

The forms and angles obtained are as in the table below, in which we have the mean result of measurements on three crystals:

<sup>2</sup> Mügge—Neues Jahrb. Min., ii., 1897, p. 78.

<sup>3</sup> Spencer—Min. Mag., xiii, 1901, p. 39, f n.

Forms.		Measured.		Calculated.		Error.					
		$\phi$	$\rho$	$\phi$	$\rho$	$\phi$	$\rho$				
		o	'	o	'	'	'				
<i>c</i>	001										
<i>b</i> <sub>1</sub>	010	0	2	89	58	0	0	2	2		
<i>m</i> <sub>1</sub>	110	58	36	89	59	58	37	"	1	1	
<i>r</i> <sub>1</sub>	130	28	35	89	59	28	39	"	4	1	
<i>x</i> <sub>1</sub>	012	0	1	19	53	0	0	19	52	1	1
<i>k</i> <sub>1</sub>	011	0	1	35	55	"	"	35	52	1	3
<i>i</i> <sub>1</sub>	021	0	2	55	23	"	"	55	20	2	3
<i>y</i> <sub>1</sub>	102	89	26	30	46	90	0	30	39	34	7
<i>l</i> <sub>1</sub>	111	58	37	54	15	58	37	54	14	0	1
<i>b</i> <sub>2</sub>	010	57	16	90	0	57	18	90	0	2	0
<i>m</i> <sub>2</sub>	110	1	20	89	59	1	19	"	"	1	1
		64	9			64	5			4	
<i>r</i> <sub>2</sub>	130	85	39	90	0	85	57	"	"	18	0
<i>x</i> <sub>2</sub>	012	57	15	19	53	57	18	19	52	3	1
<i>k</i> <sub>2</sub>	011	57	11	35	57	"	"	35	52	7	5
<i>S</i> <sub>2</sub>	032	57	12	47	33	"	"	47	19	6	14
<i>i</i> <sub>2</sub>	021	57	13	55	9	"	"	55	20	5	11
<i>y</i> <sub>2</sub>	102	32	34	30	38	32	42	30	39	8	1
<i>l</i> <sub>2</sub>	111	1	24	54	14	1	19	54	14	5	0
		64	5			64	5			0	
<i>o</i> <sub>2</sub>	112	1	29	34	46	1	19	34	46	10	0
		64	42			64	5			37	

Two groups of four crystals, twinned in pairs on *r* were measured. Denoting the four segments by I, II, III, IV, we have I and II twinned on *r*, likewise III and IV twinned on *r*, but although the orientation of III and IV relative to I and II is almost the same in the two groups I have not succeeded in proving it due to twinning on any known face. Appended are the angles obtained between the *b* pinacoids of the four segments:

- (1).  $b_1 \wedge b_2 = 57^\circ 13'$  (Calculated for *r* twin  $57^\circ 18'$ ).  
 $b_1 \wedge b_3 = 61 26$   
 $b_1 \wedge b_4 = 4 4$
- (2).  $b_1 \wedge b_2 = 57 18$   
 $b_1 \wedge b_3 = 61 54$   
 $b_1 \wedge b_4 = 4 38$

An attempt was made to determine whether the reticulated

form so common with Broken Hill cerussite is due to repeated twinning on  $r$  or twinning on  $r$  combined with twinning on  $m$  or on some other law. Suitable specimens for this purpose are not easy to get, but, from a group consisting of part of the plate forming one side of the rhomb-shaped net and two small attached crystals with elongation apparently parallel to the two remaining directions, the following measurements were obtained, all the reliable data being utilised in order to get results as accurate as possible :

$$\begin{array}{l} b_1 \wedge b_2 \quad 57^\circ 1' \quad (\text{Calculated for } r \text{ twin } 57^\circ 18). \\ b_1 \wedge b_3 \quad 58 \quad 35 \end{array}$$

From these figures it is apparent that I and II are twinned on  $r$  while III is independent, or exemplifies a third twinning law. Mügge, who was the first to describe the cerussite of Broken Hill says<sup>4</sup>:—" Neben Zwillingen kommen auch Drillinge vor, indessen wurden polysynthetische Bildungen nach (130) auch in Dünnschliffen nicht beobachtet, wohl aber Verbindungen von Zwillingen nach (130) mit gitterförmigen Drillingen nach (110), welche letztere auch durch tafelligen Habitus nach (010) sich von Zwillingen nach (130) unterscheiden." If Mügge means by this that the mesh-like form is the result of twinning on (110) combined with twinning on (130) I can only say that so far as my observations go I am not able to substantiate his conclusions. Unfortunately he does not give the measurements on which his inferences are based, and it would be absurd for me to question their correctness, but a tabular extension on  $b$  is not a criterion of distinction between twinning on (130) and twinning on (110) as the habit is a common one with cerussite.

#### ZEEHAN, TASMANIA.

(Plate lxxvii., fig. 4).

One specimen in the Museum collection shows several small but well developed crystals, simple and twinned, on a matrix of galena with patches of friable limonite. A doublet on  $m$  was measured and yielded the forms  $c$  (001),  $b$  (010),  $m$  (110),  $r$  (130),  $x$  (012),  $k$  (011),  $i$  (021),  $v$  (031),  $z$  (041),  $p$  (111). The faces in the zone [010, 001] are striated and slightly inter-oscillating. A group (Pl. lxxvii., fig. 4), is made up of four individuals of which I and II, also III and IV are twinned to each other on  $m$ , while I is twinned to III and II to IV on a possible face (760) for which the calculated value of  $\phi$  is  $62^\circ 24'$ . This form has not been recorded for cerussite, and it is just possible that we have here merely a case of accidental grouping, but the

<sup>4</sup> Mügge--*Loc. cit.*, p. 79.





## WASHINGTON EXTENDED MINE, WHYTE RIVER, TASMANIA.

(Plate lxxvi., fig. 4).

This is represented in our collection by one specimen in which small crystals of cerussite occur in cavities in galena coated with yellow limonite; in habit it is tabular on  $b$ , which is slightly striated parallel to prism and brachy-dome intersections. The angles are tabulated below :

Forms.		Measured.		Calculated.		Error.			
		$\phi$	$\rho$	$\phi$	$\rho$	$\phi$	$\rho$		
		o	'	o	'	'	'		
$l$	010	0	0	89	59	0	0	0	1
$r$	130	28	40	90	2	28	39	1	2
$x$	012	0	0	19	50	0	0	0	2
$k$	011	0	2	35	57	"	35 52	2	5
$i$	021	0	0	55	25	"	55 20	0	5
$v$	031	"	"	64	59	"	65 15	0	16
$z$	041	0	1	70	37	"	70 55	1	18
$u$	051	0	0	74	8	"	74 32	0	24
$y$	102	90	2	30	41	90	0	2	2
$p$	111	58	37	54	12	58	37	0	2

## COMET MINE, DUNDAS, TASMANIA.

(Plate lxxvi., fig. 5).

The crystals, which occur on a matrix of galena and powdery limonite, are thin tabular on  $b$  and twinned on  $m$ ; the figured crystal is a trilling resembling the cerussite of the Magnet Mine<sup>5</sup>. The two crystals twinned to that in the conventional position are small in comparison and scarcely penetrate the larger. The measured angles agree fairly well with the calculated values.

<sup>5</sup> Anderson—Rec. Austr. Mus., vi., 2, 1905, p. 93, pl. xx., f. 1-3.

Forms.		Measured.		Calculated.		Error.	
		$\phi$	$\rho$	$\phi$	$\rho$	$\phi$	$\rho$
$b_1$	010	0 3	89 58	0 0	90 0	3	2
$a_1$	100	89 57	89 56	90 0	"	3	4
$m_1$	110	58 40	89 59	58 37	"	3	1
$r_1$	130	28 40	89 58	28 39	"	1	2
$x_1$	012	0 6	19 53	0 0	19 52	6	1
$k_1$	011	"	35 55	"	35 52	6	3
$i_1$	021	0 0	55 20	"	55 20	0	0
$v_1$	031	0 3	65 12	"	65 15	3	3
$p_1$	111	58 36	54 14	58 37	54 14	1	0
$b_2$	010	62 47	89 59	62 46	90 0	1	1
$a_2$	100	27 13	90 0	27 14	"	1	0
$m_2$	110	4 7	89 58	4 9	"	2	2
$r_2$	130	{88 35 34 8	89 59	{88 35 34 7	"	{0 1	1
$v_2$	031	62 46	65 39	62 46	65 15	0	24
$b_3$	010	62 35	89 58	"	90 0	11	2
$a_3$	100	27 20	89 58	27 14	"	6	2
$m_3$	110	3 59	89 57	4 9	"	10	3
$r_3$	130	{88 48 34 3	89 58	{88 35 34 7	"	{13 4	2
$i_3$	021	62 36	55 16	62 46	55 20	10	4
$p_3$	111	3 57	54 15	4 9	54 14	12	1

## BARITE.

COMMONWEALTH MINE, WELLINGTON, NEW SOUTH WALES.

(Plate lxxviii, fig. 1).

Crystallised barite is by no means common in New South Wales; in fact the crystals now dealt with and those from St. Peter's near Sydney<sup>6</sup> are the only examples known to me.

At the Commonwealth Mine it occurs as clusters of transparent, colourless or slightly yellowish (iron stained) crystals, with prismatic development along the  $b$  axis. The faces are not quite smooth and the angles obtained are not very good.

<sup>6</sup> Anderson—Rec. Austr. Mus., vi., 2, 1905, p. 89, pl. xix., f. 2.

Forms.		Measured.		Calculated.		Error.	
		$\phi$	$\rho$	$\phi$	$\rho$	$\phi$	$\rho$
<i>c</i>	001	—	—	—	—	—	—
<i>η</i>	320	61 22	89 58	61 28	90 0	6	2
<i>m</i>	110	50 52	90 4	50 49	„	3	4
<i>o</i>	011	0 7	52 54	0 0	52 43	7	11
<i>d</i>	102	90 0	39 1	90 0	38 51	0	10
<i>u</i>	101	89 46	58 34	„	58 10	14	24
<i>f</i>	113	51 11	34 27	50 49	34 43	22	16
<i>z</i>	111	50 51	64 26	„	64 18	2	8
<i>y</i>	122	31 18	57 07	31 31	57 1	13	6

## MONAZITE.

THE GULF, NEAR EMMAVILLE, NEW SOUTH WALES.

(Plate lxxviii., fig. 2).

The crystal is reddish brown, somewhat worn and not measurable on the reflecting goniometer, but the angles obtained with the contact goniometer are sufficiently good for determinative purposes. The crystal measures  $1.5 \times 1.5 \times .5$  cm. and is twinned on (100). It is projected on the plane (010) and drawn in ideal symmetry.

Specific gravity : 5.152.

## SCHEELITE.

HILLGROVE, NEW SOUTH WALES.

(Plate lxxviii., fig. 3).

At Hillgrove scheelite has been found in considerable quantity but it seldom occurs in crystals. One specimen consisting of a number of fragmentary crystals grouped in parallel position is in our collection and is here figured. It is greyish and translucent; the faces are rough and striated, and the angles obtained with the reflecting goniometer are not very satisfactory. Specific gravity : 6.00.

	Measured.	Calculated (Dana).
$s_1 \wedge s_1^{iv}$	$= 131 \wedge 13\bar{1} = 23^\circ 20'$	$23^\circ 16'$
$s_1 \wedge p$	$= 131 \wedge 111 = 28 18$	$28 21$
$s_1 \wedge e$	$= 131 \wedge 101 = 67 12$	$68 18\frac{1}{2}$

## MOUNT RAMSAY, TASMANIA.

(Plate lxxviii., fig. 4).

This is the mineral analysed by Traube<sup>7</sup>. It occurs in hornblende rock in well formed crystals up to one inch in length and in crystalline bunches. The measured crystal is about 1 cm. in the direction of the vertical axis and is greyish and semi-translucent. The faces are fairly brilliant and gave good signals; only the pyramid *e* (101) is present.

Measured.		Calculated (Dana).	
$e \wedge e'$	$= 101 \wedge 011 = 72^\circ 45'$	$72^\circ 40\frac{1}{2}'$	
$e \wedge e^{m'}$	$= 101 \wedge 0\bar{1}\bar{1} = 107 15$	$107 19\frac{1}{2}$	

## VESUVIANITE.

BARRABA, NEW SOUTH WALES.

(Plate lxxviii., figs. 5, 6).

Vesuvianite is found as yellowish-green transparent crystals in and near a cutting on the road from Barraba to Bundarra, slightly eastward of the Ironbarks Creek crossing. It has been described by Mr. D. A. Porter<sup>8</sup>, who states that it is found lining cavities in massive garnet forming a vein in serpentine. The crystals are accompanied by silica in the form of hyalite, and a greenish mineral in thin tabular, hexagonal crystals which has not yet been determined but may belong to the chlorite group. The base is usually present but is invariably rough and non-reflecting.

One of the best and largest crystals,  $3.5 \times 1$  mm., was measured and gave the following forms and angles:

Forms.		Measured.		Calculated.		Error.	
		$\phi$	$\rho$	$\phi$	$\rho$	$\phi$	$\rho$
<i>c</i>	001	—	—	—	—	—	—
<i>a</i>	100	0 5	90 0	0 0	90 0	5	0
<i>m</i>	110	45 1	89 45	45 0	„	1	15
<i>o</i>	011	0 37	28 15	0 0	28 15	37	0
<i>p</i>	111	45 10	37 12	45 0	37 14	10	2
<i>t</i>	331	44 56	66 46	„	66 19	4	27
<i>s</i>	131	18 27	59 41	18 26	59 32	1	9
<i>i</i>	132	18 16	40 7	„	40 22	10	15

<sup>7</sup> Traube—Neues Jahrb. Min., Beil.-Bd. vii., 1890, p. 232, quoted Dana's System of Mineralogy, 6th Edition, 1892, p. 987.

<sup>8</sup> Porter—Journ. Roy. Soc. N.S. Wales, xxii., 1888, p. 85, pl. i, f. 12.

## ZEOLITES.

Wherever we find decomposed felspathic rocks we may look for zeolites in their amygdaloidal cavities. Generally several zeolitic species occur together, sometimes forming intergrowths, and, as in crystalline habit, qualitative and even quantitative composition certain zeolites have a strong family resemblance it is not always easy to discriminate between them. In this paper I have confined myself to describing those of whose identity there is no reasonable doubt.

### CHABAZITE.

BEN LOMOND, NEW SOUTH WALES.

(Plate lxxix., figs. 1, 2).

The basalt of Ben Lomond is much decomposed and so full of cavities that in hand specimens it sometimes presents the vesicular appearance of pumice. The smaller cavities are often completely filled with an incoherent, yellowish-green substance which has a clayey odour when wetted; the powder has not been analysed but is probably bole or some equally indefinite mineral of the kaolin group. Larger cavities are filled with zeolites sometimes beautifully crystallised; chabazite predominates and is accompanied by analcite and delicate acicular crystals which are mainly mesolite but may possibly be natrolite in some cases. Yellowish calcite in scalenohedra or in spherical aggregates accompanies the zeolites. The specimens in the Museum collection were obtained by purchase from Mr. D. A. Porter who has also supplied us with particulars of the occurrence.<sup>9</sup> The specimens were obtained from excavations and cuttings on the Northern Railway line, the finest being found in the "Big Cutting" situated about a mile in a northerly direction from Ben Lomond railway station.

The chabazite is sometimes crystallised in simple rhombohedra much striated parallel to the edges  $r/r'$  and  $r/r''$  or forms unequal interpenetrating twins with the vertical axis as axis of twinning, but it usually presents the characteristic form of phacolite with the forms  $r$  (10 $\bar{1}$ 1),  $s$  (02 $\bar{2}$ 1) and  $e$  (01 $\bar{1}$ 2) twinned on the same law. The crystals, which attain a diameter of 3 cm., are but little inferior to the well-known phacolite of Richmond, Victoria; they are less regularly developed however, and are strongly striated parallel with the intersections  $r/e$ . A common feature is a crateriform depression at the apex shown in plan in Pl. lxxix., fig. 2. In such crystals each individual of the twin really consists of three portions in parallel position.

---

<sup>9</sup> Porter—Journ. Roy. Soc. N.S. Wales, xxii., 1888, p. 87.

Four analyses (III and IV being duplicates) were made with the following result :

	I.	II.	III.	IV.	V.	VI.	VII.
H <sub>2</sub> O @ 100° C -	21.67	21.30	3.43	not det.	3.43	22.11	21.3
H <sub>2</sub> O @ 100° C +	47.70	46.85	19.11	47.53	18.41	47.52	47.4
SiO <sub>2</sub>	19.34	20.14	47.41	18.53	47.37	19.48	20.2
Al <sub>2</sub> O <sub>3</sub>	9.05	10.72	18.63	9.09	19.16	9.63	11.1
CaO	—	—	9.21	—	9.52	.43	—
SrO	0.47	0.80	—	1.40	—	.36	—
K <sub>2</sub> O	1.06	0.97	1.05	1.33	0.93	.52	—
Na <sub>2</sub> O	—	—	1.08	—	1.11	—	—
	99.29	100.78	99.92	—	99.93	100.05	100.0





For analysis material was selected from several specimens carrying analcite in druses and cavities.

	I.	II.	III.
	%	%	%
H <sub>2</sub> O ...	8.71(ign)	8.37	8.2
SiO <sub>2</sub> ...	54.39	55.81	54.5
Al <sub>2</sub> O <sub>3</sub> ...	21.76	22.43	23.2
CaO ...	1.33	—	—
K <sub>2</sub> O ...	tr.	—	—
Na <sub>2</sub> O ...	13.77	13.47	14.1
	99.96	100.08	100.0

I.—Ben Lomond, N. S. Wales; taken for water .1492 gram, general .3539 gram.

II.—Table Mt., Colorado.<sup>13</sup>

III.—Calculated for Na<sub>2</sub>O. Al<sub>2</sub>O<sub>3</sub>. 4SiO<sub>2</sub>. 2H<sub>2</sub>O.

### MESOLITE.

#### BEN LOMOND, NEW SOUTH WALES,

The slender crystals are too minute for optical determination; extinction is sensibly straight. The mineral fuses to an opaque white bead giving the sodium flame. For analysis a vugh lined with a downy covering of interlacing acicular crystals was denuded, yielding, .5509 gram, of apparently pure material. Water was determined by ignition.

	I.	II.	III.	IV.
	%	%	%	
H <sub>2</sub> O ...	11.86	12.16	11.75	12.4
SiO <sub>2</sub> ...	43.88	46.17	43.83	46.4
Al <sub>2</sub> O <sub>3</sub> ...	27.14	26.88	29.04	26.3
CaO ...	7.03	8.77	7.84	9.6
K <sub>2</sub> O ...	tr.	—	—	—
Na <sub>2</sub> O ...	10.48	6.19	7.80	5.3
	100.39	100.17	100.26	100.0

<sup>13</sup> Hillebrand—*Loc. cit.*, p. 29.

I.—Ben Lomond, N.S. Wales.

II.—Table Mt., Colorado.<sup>14</sup>

III.—Eisenach, Thuringia.<sup>15</sup>

IV.—Calculated for  $\left\{ \begin{array}{l} \text{Na}_2\text{O}, \text{Al}_2\text{O}_3, 3\text{SiO}_2, 2\text{H}_2\text{O}. \\ 2 (\text{CaO}, \text{Al}_2\text{O}_3, 3\text{SiO}_2, 3\text{H}_2\text{O}). \end{array} \right.$

### NATROLITE.

INVERELL, NEW SOUTH WALES.

The mineral occurs as transparent colourless aggregates, radiated in structure. Extinction is straight and compensation takes place with quartz wedge perpendicular to direction of elongation.

	I.	II.	IV.
	%		
H <sub>2</sub> O @ 100° C -	0·38	{ 9·84	9·5
H <sub>2</sub> O @ 100° C +	8·90		
SiO <sub>2</sub> ... ..	46·38	47·31	47·4
Al <sub>2</sub> O <sub>3</sub> ... ..	27·36	26·77	26·8
CaO ... ..	0·83	0·41	—
K <sub>2</sub> O ... ..	0·13	0·35	—
Na <sub>2</sub> O ... ..	15·63	15·44	16·3
	99·61	100·12	100·0

I.—Inverell, N.S. Wales ; taken for water ·6459 grams, general ·8978 grams.

II.—Cape Blomidon, Nova Scotia.<sup>16</sup>

III.—Calculated for Na<sub>2</sub>O, Al<sub>2</sub>O<sub>3</sub>, 3SiO<sub>2</sub>, 2H<sub>2</sub>O.

### THOMSONITE.

INVERELL, NEW SOUTH WALES.

This is white, radiated, decrepitates before the blowpipe, intumescens slightly and yields an opaque white bead. Analysis was made in duplicate :

<sup>14</sup> Hillebrand—*Loc. cit.*, p. 35.

<sup>15</sup> Luedeeke—*Neues Jahrb. Min.*, 1881, ii., p. 34.

<sup>16</sup> Brush—*Amer. Journ. Sci.*, xxxi., 1861, p. 365.

	I.	II.	III.	IV.
	%	%	%	%
H <sub>2</sub> O @ 100° C -	·68	} not det.	{ 12·91	{ 13·75
H <sub>2</sub> O @ 100° C +	12·05			
SiO <sub>2</sub> ... ..	40·60	40·76	40·88	37·00
Al <sub>2</sub> O <sub>3</sub> ... ..	29·67	29·79	29·68	31·39
CaO ... ..	11·74	11·58	11·88	11·50
Na <sub>2</sub> O ... ..	5·62	5·87	4·72	6·36
	100·36	—	100·07	100·00

I.—Inverell ; taken for water ·4240 gram, general ·4820 gram.

II.—Inverell ; taken ·5395 gram.

III.—Table Mt., Colorado.<sup>17</sup>

IV.—Calculated for  $\left\{ \begin{array}{l} \text{Na}_2\text{O}, \text{Al}_2\text{O}_3, 2\text{SiO}_2, 2\frac{1}{2}\text{H}_2\text{O}. \\ 2 (\text{CaO}, \text{Al}_2\text{O}_3, 2\text{SiO}_2, 2\frac{1}{2}\text{H}_2\text{O}). \end{array} \right.$

### SCOLECITE

WERRIS CREEK, NEW SOUTH WALES.

This mineral is associated with heulandite and stilbite in a decomposed andesitic rock containing phenocrysts of plagioclase almost completely zeolitised ; the scolecite occurs as white nodular radiated masses. Before the blowpipe intumescs slightly and fuses to a blebby enamel. Mr. D. A. Porter who presented the specimens to the Trustees informs me that it is rather rare at the locality.

The mineral gelatinises with hydrochloric acid and yielded the following percentages :

	I.	II.	III.
	%	%	%
H <sub>2</sub> O ... ..	13·94	14·48(diff.)	13·8
SiO <sub>2</sub> ... ..	45·19	46·03	45·9
Al <sub>2</sub> O <sub>3</sub> ... ..	25·56	25·28	26·0
Fe <sub>2</sub> O <sub>3</sub> ... ..	—	0·27	—
CaO ... ..	15·39	12·77	14·3
K <sub>2</sub> O ... ..	{ 0·74	0·13	—
Na <sub>2</sub> O ... ..		1·04	—
	100·82	100·00	100·0

<sup>17</sup> Hillebrand—*Loc. cit.* p. 25.

I.—Werris Ck., N.S. Wales; taken for water 4540 gram general 7504 gram.

II.—Table Mt., Colorado.<sup>18</sup>

III.—Calculated for  $\text{CaO} \cdot \text{Al}_2\text{O}_3 \cdot 3\text{SiO}_2 \cdot 3\text{H}_2\text{O}$ .

### HEULANDITE.

WERRIS CREEK, NEW SOUTH WALES.

(Plate lxxviii., fig. 7).

At Werris Creek heulandite occurs as minute transparent colourless crystals lining small amygdaloidal cavities in the decomposed rock. It has the usual pearly lustre on the clinopinacoidal cleavages, which are found to be perpendicular to an acute positive bisectrix, thus distinguishing the mineral from stilbite which otherwise it resembles closely. The crystals have the characteristic coffin shape, the forms present being *b* (010), *m* (110), *x* (021), *t* (201), *u* ( $\bar{1}11$ ), *s* ( $\bar{2}01$ ). The available material is too scanty to permit an analysis.

### STILBITE.

JAMBEROO, NEW SOUTH WALES.

This locality was discovered by Mr. B. G. Engelhardt by whom the mineral, which occurs in trachyte, has already been described.<sup>19</sup> An analysis was made on a specimen in the Australian Museum presented by the original discoverer, with the appended result:

	I.	II.	III.
	$\frac{\circ}{\circ}$	$\frac{\circ}{\circ}$	$\frac{\circ}{\circ}$
H <sub>2</sub> O ...	17.53	17.30	17.2
SiO <sub>2</sub> ...	57.61	58.79	57.4
Al <sub>2</sub> O <sub>3</sub> ...	15.56	14.61	16.3
Fe <sub>2</sub> O <sub>3</sub> ...		0.47	—
CaO ...	8.22	9.53	7.7
K <sub>2</sub> O ...	1.19	0.23	—
Na <sub>2</sub> O ...		0.32	1.4
	100.11	101.25	100.0

I.—Jamberoo; taken for water 2755 gram, general 5593 gram.

II.—Bordö, Faroes.<sup>20</sup>

III.—Calculated for  $(\text{Na}_{25}\text{Ca}) \text{O} \cdot \text{Al}_2\text{O}_3 \cdot 6\text{SiO}_2 \cdot 6\text{H}_2\text{O}$ .

<sup>18</sup> Hillebrand—*Loc. cit.*, p. 37.

<sup>19</sup> Engelhardt—*Proc. Linn. Soc. N.S. Wales*, (2), vi., 1891, p. 5, pl. i.; Jaquet and Card—*Rec. Geol. Surv. N.S. Wales*, viii., 1, 1905, p. 17.

<sup>20</sup> Heddle—*Min. Mag.*, i., 1877, p. 21.

## OCCASIONAL NOTES.

---

### VII.—EGGS OF *CACOMANTIS INSPERATUS*, GOULD

The eggs of the Brush Cuckoo of Gould's folio edition of the "Birds of Australia" were unusually common last season on the highlands of the Milson's Point Railway Line. Mr. A. A. Johnston took no less than seven eggs in as many nests of *Rhipidura albiscapa*. One nest four feet from the ground that he had to lift the bird off, revealed two eggs of the Brush Cuckoo, and one egg of *Rhipidura albiscapa*. This was on the 24th November, 1906. The nest of this pair of birds he took again on the 9th January, 1907, when it contained two eggs of the White-shafted Fantail and one egg of the Brush Cuckoo. On the 5th January, 1907, he took a nest of *Malurus lamberti* with two eggs, also an egg of the Brush Cuckoo, which is the first time I have known the egg of this Cuckoo to be found in the nest of this species. Four fresh eggs were taken from a nest of the same pair of birds on the 16th January, and two eggs of Lambert's Superb Warbler from the third nest of this pair of birds, on the 29th January, 1907, also an egg of the Brush Cuckoo. On the 18th November, 1906, Mr. Johnston took a nest of *Myiagra rubecula*, containing two eggs of that species, also an egg of the Brush Cuckoo.

As I have pointed out in "The Ibis,"<sup>1</sup> the *Cacomantis insperatus* of Gould, agrees with Latham's description and figure of *Cuculus flabelliformis*, but not the species, the latter name has been applied by writers in general.

ALFRED J. NORTH.

---

<sup>1</sup> North—The Ibis, 1906, p. 53.









12351

RECORDS  
OF THE  
AUSTRALIAN MUSEUM.

EDITED BY THE CURATOR.

---

Vol. VI., No. 6.

---

PRINTED BY ORDER OF THE TRUSTEES.

R. ETHERIDGE, JUNR., J.P.,

Curator.

FRIDAY, 20th MARCH, 1908.



# INDEX.

	PAGE		PAGE
Aboriginal Workshops N.S.		ALLOPTES <i>corymbophorus</i> ...	186
Wales, see Workshops		<i>lobulatus</i> ...	185
ACANTHISTIUS <i>serratus</i> ...	61	<i>major</i> ...	186
<i>acanthopterus</i> , MUREX ...	287	<i>securiger</i> ...	185
<i>acanthurus</i> , SEIUS ...	173	<i>allporti</i> , MARGINELLA 214, 287, 295	
ACARUS <i>domesticus</i> ...	181	<i>alveata</i> , CUSPIDARIA ...	363
<i>exulcerans</i> ...	189	<i>alveolatum</i> , SPHEROZOUM ...	281
<i>farinæ</i> ...	180	<i>alveoliformis</i> , MILIOLINA ...	306
<i>folliculorum</i> ...	192	<i>alveoliniformis</i> , POLYMORPHINA ...	305, 308
<i>gallinæ</i> ...	174	AMAUROBIUS <i>socialis</i> ...	9
<i>timacum</i> ...	150	AMBYLONMA <i>hydrosauri</i> ...	169
<i>reflexus</i> ...	163	<i>limbatum</i> ...	170
<i>scabiei</i> ...	189	<i>morelie</i> ...	170
<i>siro</i> ...	180, 189	<i>postoculatum</i> ...	170
<i>tetarius</i> ...	153	<i>trigittatum</i> ...	170
<i>acclinis</i> , LIMEA ...	46, 223	<i>ambulans</i> , ECHIDNOPHAGA ...	101
ACHORUTES, <i>speciosus</i> ...	314	<i>americanus</i> , ARGAS ...	164
<i>acicula</i> , CLIO ...	285	<i>ammonoides</i> , OPERCULINA ...	310
ACMEEA <i>parva</i> , var. <i>tasmanica</i> ...	215	AMPHISILE <i>cristata</i> ...	60
ACRILLA <i>minutula</i> ...	52	AMPHITHALMUS <i>pyramidatus</i> ...	285
ACTEON <i>austriana</i> ...	285	AMPHORA, sp. ...	306
<i>rosea</i> ...	285	AMUSIUM <i>thetidis</i> , 41, 213, 223, 285	
<i>acuminata</i> , ROCHEFORTIA 214, 288		<i>anaeanthes</i> , SARCOPTES ...	190
ADACNARCA ...	46	Analcite, Ben Lomond, N.S.	
<i>squamea</i> ...	45, 213, 285	Wales ...	418
ADEORBIS <i>angulata</i> ...	50	<i>anale</i> , SCYLLIUM ...	228
ADMETE <i>stricta</i> ...	285, 295	ANALGESIDE ...	181
ÆOLISCUS <i>strigatus</i> ...	59	ANALGES <i>tetracentrus</i> ...	185
<i>aquilateralis</i> , GLOBIGERINA ...	309	<i>analis</i> , CATULUS, egg-case ...	228
<i>affinis</i> , BERYX ...	60	<i>analis</i> , NERLENE ...	331
<i>affinis</i> , PROTOLICHUS ...	184	<i>analis</i> , SCYLLIORHINUS ...	228
<i>affinis</i> , PTEROLICHUS ...	183, 184	ANANUS <i>tarsonemus</i> ...	178
<i>agapeta</i> , MARGINELLA ...	214	<i>anas</i> z, TARSONEMUS ...	178
AGAUE <i>brevipalpus</i> ...	161	ANCOCELUS ...	28
<i>agglutinans</i> , TEXTULARIA ...	307	<i>livens</i> ...	28
<i>agnata</i> , BATHYTOMA 213, 220, 285		<i>angasi</i> , CARDITELLA 213, 285	
<i>alastoris</i> , HETEROPUS ...	177	<i>angasi</i> , COLUMBELLA ...	285
<i>alastoris</i> , PEDICULOIDES ...	177	<i>angasi</i> , CUSPIDARIA ...	213
<i>alazon</i> , LIOTIA ...	49	<i>angasi</i> , GAFFRARIUM ...	286
<i>alba</i> , COLUMBELLA ...	298	<i>angasi</i> , MARGINELLA ...	42
<i>alba</i> , MITROMORPHA ...	287, 298	<i>angasi</i> , ROCHEFORTIA ...	288
<i>albida</i> , MYODORA ...	287, 301	Anglesite, Lewis Ponds, N.S.	
<i>albigena</i> , THYASIRA ...	363	Wales ...	92
<i>albicinctis</i> , ARTAMUS ...	341	Maestrie's Mine, Dundas, Tasmania ...	90
<i>albo-striatum</i> , THERIDIUM ...	27	Mine Meretrix, New Caledonia ...	91, 97
ALEUROBIUS <i>farinæ</i> ...	180	<i>angulata</i> , ADEORBIS ...	50
ALEUTERIUS <i>brownii</i> ...	80	<i>angulata</i> (var.), CAVOLINIA	
ALLOMORPHINA <i>trigona</i> ...	307	<i>angulata</i> sp. ...	285
<i>trigonula</i> ...	306		
sp. ...	307		

	PAGE
<i>angulata</i> , CITHNA ...	285, 291
<i>anguilla</i> , EUCTA ...	332
ANISOMYON <i>depressus</i> ...	328
<i>annularis</i> (var.), LAGENA	
<i>sulcata</i> ...	307, 311
<i>annulata</i> , LIOTIA ...	42
<i>annulatus</i> , RHIPICEPHALUS	166
<i>annulatus</i> , (var.) <i>australis</i> ,	
RHIPICEPHALUS ...	167
<i>anonata</i> , PSEUDAVICULA ...	319
ANOMALINA <i>ariminenis</i> ...	309
<i>grosserugosa</i> ...	309
<i>antarctica</i> , SCIENA ...	63
<i>antipodiana</i> , ARGYRODES ...	25
APISTUS <i>marmoratus</i> ...	201
APONOMMA <i>concolor</i> ...	169
<i>decorosum</i> ...	168
<i>ecinctum</i> ...	169
<i>hydrosauri</i> ...	169
<i>trimaculatum</i> ...	168
<i>aptenodytum</i> , CHEILOBRAN-	
CHUS ...	196
<i>aquilinus</i> , var. <i>milvulina</i> ,	
PSEUDALLOPTES ...	184
<i>aquilinus</i> , var. <i>milvulina</i> ,	
PTEROLICHUS ...	184
ARACANA <i>aurita</i> ...	82
<i>lenticularis</i> ...	82
<i>arachis</i> , CYLICHNA ...	286
<i>arata</i> , MONILEA ...	214, 287
<i>araucana</i> , DISCOREBINA ...	309
ARCA <i>reticulata</i> ...	41, 285
ARCHITECTONICA <i>atkinsoni</i>	285
<i>reevei</i> ...	285
<i>arcuatum</i> , COLLOZOUM ...	278
ARFULARIA <i>dipsacoides</i> ...	359
<i>arenaria</i> , ASTRORHIZA ...	307
<i>arenaria</i> , SPIROLOCULINA ...	306
<i>arenosa</i> , THRACIOPSIS ...	42, 288
ARGAS <i>americanus</i> ...	164
<i>persicus</i> ...	164
<i>reflexus</i> ...	163
sp. ...	164
ARGASIDÆ ...	163
ARGIOPIDÆ ...	330
ARGYRODES ...	25
<i>antipodiana</i> ...	25
<i>incisifrons</i> ...	25
<i>margaritarius</i> ...	25
ARGYROPEIRA <i>celebesiana</i> ...	335
<i>granulata</i> ...	335
ARIANNES ...	24
<i>colubrinus</i> ...	24
<i>arianus</i> , PHYTOPHUS ...	192

	PAGE
<i>ariminenis</i> , ANOMALINA ..	309
<i>armata</i> , SCIENA ...	71
<i>armatus</i> , COLLOZOUM ...	275
<i>armatus</i> , CARANX ...	71
<i>armatus</i> , PATÆCUS ...	76, 77
<i>aroniæ</i> , PHYTOPHUS ...	192
ARTAMUS <i>albiventris</i> ...	341
<i>aruanus</i> , MEGALATRACTUS ...	98
ASPASMOGASTER ...	315
ASPELLA <i>undata</i> ...	285, 294
<i>asperrimus</i> , CHLAMYS ...	213
<i>assarius</i> , CHÆTODON ...	66
ASTARTE <i>wollumbillaensis</i> ...	327
ASTELE <i>bilix</i> ... ..	48
<i>glyptus</i> ...	213
ASTORRHIZA <i>arenaria</i> ...	307
ATAX <i>cumberlandensis</i> ...	160
<i>atkinsoni</i> , ARCHITECTONICA	285
<i>atkinsoni</i> , SCHISMOPE ...	42, 288
ATLANTA <i>fusca</i> ...	285
<i>inclinata</i> ...	285
<i>keraudrenii</i> ...	299
<i>rosea</i> ...	285
<i>atlanticum</i> , BELONOZOUM ...	279
ATYS <i>pransa</i> ...	285
AUCELLA <i>hughendenensis</i> ...	321
AULOPUS <i>purpurissatus</i> ...	59
<i>aurita</i> , ARACANA ...	82
<i>auritus</i> , OSTRACION ...	82
<i>australe</i> , FLABELLUM ...	272
<i>australiana</i> , CELÆNOPSIS ...	172
<i>australiensis</i> , VERTICORDIA	303
<i>australis</i> , CARINARIA ...	213, 223
<i>australis</i> , EPISINUS ...	25
<i>australis</i> , GLYPHIDODON ...	69
<i>australis</i> , MODIOLA ...	287
<i>australis</i> , PORTHEUS ...	7
<i>australis</i> , PROTALGES ...	185
<i>australis</i> (var.), RHIPICEPH-	
ALUS <i>annulatus</i> ...	167
<i>australis</i> , SCISSURELLA ...	288
<i>australis</i> , (var.), SYMPHURUS	
<i>strictus</i> ...	319
<i>austrina</i> , ACTEON ...	285
<i>avellanoides</i> , CYPRÆA ...	293
<i>avellanoides</i> , TRIVIA ...	288, 293
AVICULA <i>corbiensis</i> ...	320
<i>hughendenensis</i> ...	321
<i>arium</i> , DERMANYSSUS ...	174
Axinite, Bowling Alley Point,	
N. S. Wales ...	133
Colebrook Mine, Dun-	
das, Tasmania ...	135
Moonbi, N.S. Wales ...	135

B		PAGE
<i>babylonica</i> , PYRENE ...	359	
<i>badius</i> , SIRIUS ...	42, 288	
<i>baillonii</i> , CÆSIOMORUS ...	71	
<i>baillonii</i> , TRACHINOTUS ...	71	
<i>BALISTES chinensis</i> ...	79	
<i>granulatus</i> ...	80, 210	
<i>hippocrepsis</i> ...	80	
<i>penicilligerus</i> ...	80	
<i>bancrofti</i> , TARSONEMUS ...	177	
Barite, Commonwealth Mine, N.S. Wales ...	413	
St. Peters, Sydney ...	90	
<i>BASILISSA radialis</i> ...	285	
<i>bassensis</i> , PELTORHAMPHUS ...	198	
<i>bassensis</i> , RHOMBOSOLEA ...	198	
<i>bassi</i> , LIMA ...	287	
<i>BATHYARCA perversidens</i> ...	41, 285	
<i>BATHYPHANTES webardi</i> ...	331	
<i>BATHYTOMA agnata</i> ...	213, 220, 285	
<i>sarcinula</i> ...	53	
<i>beddomei</i> , POLINICES ...	288	
<i>bellicosum</i> , EPITONIUM ...	360	
<i>BELONZOUM atlanticum</i> ...	279	
<i>hilli</i> ...	279	
<i>BERLESIA rapar</i> ...	173	
<i>berthelotti</i> , DISCORBINA ...	309	
<i>BERYX affinis</i> ...	60	
<i>bicolor</i> , RISSOA ...	288	
<i>bicornis</i> , JANULUS ...	25	
<i>bicornis</i> , MILIOLINA ...	306	
<i>bilic</i> , ASTELE ...	48	
<i>BILUCULINA ringens</i> ...	306	
<i>bimaculatus</i> SCOLOPSIS ...	63	
<i>biocellatus</i> , GLYPHISODON ...	68, 69	
<i>bitorquata</i> , DAPHNELLA ...	298	
<i>bitorquatus</i> , HOPLOCEPHALUS ...	38	
<i>BITTIUM fuscocapitulum</i> ...	213, 217	
<i>BLENNIUS tasmanianus</i> ...	205	
<i>BOLIVINA pygmaea</i> ...	307	
<i>textularoides</i> ...	307	
<i>BOOPHILUS boris</i> ...	166	
<i>BORNIA radiata</i> ...	48	
<i>bostockii</i> , LABRICHTHYS ...	70	
<i>boris</i> , BOOPHILUS ...	166	
<i>boris</i> , IXODES ...	166	
<i>brachiatus</i> , var. <i>crassior</i> , PROTOLICHUS ...	183	
<i>brachiatus</i> , var. <i>crassior</i> , PTEROLICHUS ...	183	
<i>brachyurus</i> , CARCHARIAS ...	226	
<i>BRAMICHTHYS</i> ...	72	
<i>woodwardi</i> ...	72	
<i>BRANCHIUR pleurotheca</i> ...	256	
<i>brandtii</i> , RHAPHIDOZOUM ...	280	
<i>brazieri</i> , CRYPTOPORA ...	286	
<i>brazieri</i> , CUSPIDARIA ...	286	
<i>brazieri</i> , LIMOPSIS ...	287	
<i>brazieri</i> , MARGINELLA ...	214, 287	
<i>brevipalpus</i> , AGAUE ...	161	
<i>brevipes</i> , HETERACTITUS ...	343	
<i>brevirostris</i> , MELITHREPTUS, Insular form of ...	20	
<i>broadhursti</i> , CYNOGLOSSUS ...	73	
<i>brownii</i> , ALEUTERIUS ...	80	
<i>brownii</i> , PSEUDOMONACANTHUS ...	80	
<i>brownriggii</i> , GLYPHIDODON ...	69	
<i>brownriggii</i> , GLYPHISODON ...	68	
<i>BRYOBIA gloriosa</i> ...	152	
<i>nobilis</i> ...	152	
<i>pratiosa</i> ...	152	
<i>ribis</i> ...	152	
<i>speciosa</i> ...	152	
sp. ...	152	
<i>BUCCINUM incisum</i> ...	99	
<i>BULLA incommoda</i> ...	213, 285	
<i>bullata</i> , LIMA ...	42, 287	
<i>BULLINA scabra</i> ...	213	
<i>bulloides</i> , GLOBIGERINA ...	305, 309	
<i>bulloides</i> , var. <i>triloba</i> , GLO- BIGERINA ...	309	
Burial, Cannibalistic ...	399, 402	
Cave ...	398	
Ceremonies, Bloomfield River ...	384	
Boulia ...	393	
Brisbane ...	398	
Cape Bedford ...	372	
Cape York ...	368	
Central East Coast Queensland ...	396	
Cloncurry ...	395	
Georgina River ...	396	
North Queensland ...	365	
Princess Charlotte Bay ...	371	
Tully River ...	388	
Cremation ...	398	
Decorations ...	368, 371, 394, 403	
Desiccation ...	393	
Earth ...	389, 398	
Gypsum Cap ...	394, 395	
Inheritance of widow and property ...	367, 390, 394	
Inquest ...	366	
Memento by notched trees ...	399	
Mourning ...	382, 384, 385, 394, 396	
Offerings ...	395	
Propitiation of spirit ...	366	
Sea ...	398	
Sexual mutilation of dead ...	399	
Song ...	391	

	PAGE		PAGE
Burial Ceremonies, North Queensland, continued		CARETTOCHELYS .. ..	116
Sorcery, Detection of		<i>insculpta</i> ... ..	110
Murder by 370, 371,		CARINARIA <i>australis</i> ...	213, 223
383, 386, 392, 395,		<i>carinata</i> , CROSSEA ...	42, 286
396, 397, 400, 402		Carminite, Magnet Mine, Tas-	
Tree ... ..	396, 397, 401	mania ... ..	141
Vengeance, Extraction		<i>cartus</i> , PROTALGES ... ..	185
of ... ..	372, 381, 387	<i>casearia</i> , PLEUROTOMA ...	214, 220
Women and children		CASSIDEA <i>pyrum</i> ... ..	213
397, 398, 402		Cassiterite, El'smore, N.S.	
<i>buxinus</i> , ELEGINUS... ..	39	Wales ... ..	405
<i>bursinus</i> PSEUDAPHRITIS ...	39	Emmaville, N.S. Wales	404
		Hogue's Creek, N.S.	
		Wales ... ..	406
		Stanthorpe, Queensland	407
		The Glen, N.S. Wales	406
		<i>castaneothorax</i> , MUNIA ...	342
		<i>cati</i> , NOTEDRUS ... ..	188
		<i>cati</i> , NOTEDRES ... ..	188
		<i>cati</i> , SARCOPTES ... ..	188
		<i>cati</i> var. SARCOPTES <i>notoedres</i>	188
		CATULUS <i>analis</i> , egg-case ...	228
		<i>labiosus</i> ... ..	57
		<i>caudacuta</i> , TROUSSARTIA ...	186
		<i>caudacutus</i> , PTEROCOLUS ...	186
		<i>caudifera</i> , EUCTA ... ..	332
		<i>cautus</i> , THALASSOGERON ...	344
		<i>cavatica</i> , CARDITA ... ..	41
		<i>cavatica</i> , VENERICARDIA ...	215, 289
		CAVOLINIA <i>gibbosa</i> ... ..	213
		<i>inflexa</i> ... ..	213, 285
		<i>longirostris</i> ... ..	213
		<i>longirostris</i> , var. <i>an-</i>	
		<i>gulata</i> ... ..	285
		<i>longirostris</i> , var. <i>stran-</i>	
		<i>gulata</i> ... ..	285, 299
		<i>quadridentata</i> ... ..	213
		<i>tridentata</i> ... ..	213, 285
		<i>trispinosa</i> ... ..	213, 285
		CELENO ... ..	172
		CELÉNOPSIS <i>australiana</i> ...	172
		<i>celebesiana</i> , ARGYROEPEIRA	335
		<i>celeripes</i> , RHYNCHOLOPHUS	155
		CENTRISCUS <i>scutatus</i> ... ..	59
		CENTROGENYS <i>vaigensis</i> ...	61
		CERATOPHYLLUS <i>hilli</i> ... ..	103
		<i>rothschildi</i> ... ..	103
		CERITHIOPSIS <i>cacaminatus</i>	213, 218
		<i>halligani</i> ... ..	51
		Cerussite, Broken Hill, N.S.	
		Wales ... ..	407
		Comet Mine, Tasmania	412
		Magnet Mine, Tasmania	93
		Washington Extend-	
		ed Mine, Tasmania	412
		Zeehan, Tasmania ... ..	410

## C

CACOMANTIS <i>insperatus</i> , eggs	423
<i>cacaminatus</i> , CERITHIOPSIS	213, 218
CADULUS <i>spretus</i> ... ..	213, 285
<i>cæcus</i> , DIPULUS ... ..	78
CÆSIOMORUS <i>bailloni</i> ... ..	71
<i>calcaratus</i> , RHIPICEPHALUS	166
<i>calcar</i> , CRISTELLARIA	305, 308
<i>calcarifer</i> , HOLOCENTRUS ...	62
<i>calcarifer</i> , LATES ... ..	62
<i>calcar</i> , ROTALIA ... ..	310
CALYPTRÆA <i>calyptreæformis</i>	41
<i>calyptreæformis</i> , CALYPTRÆA	41
CAMPAGES ... ..	43
<i>furcifera</i> ... ..	43
CAMPYLOCHIRUS <i>chelopus</i> ...	187
<i>canariensis</i> , UVIGERINA ...	309
CANCELLARIA <i>micra</i> ... ..	361
<i>scobina</i> 213, 222, 285, 360	
CANCELLARIA <i>terrareginensis</i>	327
CANDEINA <i>nitida</i> ... ..	309
<i>canis</i> , SARCOPTES ... ..	189
<i>capitata</i> , LIOTIA ... ..	357
CAPULUS <i>devotus</i> ... ..	41, 213, 285
<i>caput-medusæ</i> , FREYANA ...	182
<i>caput-medusæ</i> , MICHAELIA	182
CARANX <i>armatus</i> ... ..	71
<i>speciosus</i> ... ..	71
CARCHARIAS <i>brachyurus</i> ...	226
<i>macrurus</i> ... ..	226
<i>cardinalis</i> , DIPLOCREPIS	204, 205
<i>cardinalis</i> , GOBIESOX ... ..	205
CARDITA <i>cavatica</i> ... ..	41
<i>dilecta</i> ... ..	41
CARDITELLA <i>angasi</i> ... ..	213, 285
CARDIUM <i>pulchellum</i> ... ..	213, 285
<i>zarduelis</i> , TROPHON... ..	214

	PAGE		PAGE
Chabazite, Bell Mount, Tasmania ... ..	418	<i>tasmanica</i> ... ..	213, 215
Ben Lomond, N.S. Wales ... ..	416	CÆLORHYNCHUS <i>fasciatus</i> ... ..	318, 355
Inverell, N.S. Wales ... ..	418	<i>innotabilis</i> ... ..	318
CHÆTODERMIS <i>maccullochi</i> ... ..	81	<i>coercita</i> , COCCULINA ... ..	285, 289
<i>penicilligerus</i> ... ..	80	<i>collare</i> , PARASCYLLIUM, egg-case ... ..	229
CHÆTODON <i>assarius</i> ... ..	66	COLLODINIUM ... ..	274
<i>truncatus</i> ... ..	67	COLLOSOPHÆRA <i>globularis</i> ... ..	282
CHÆTODONTIDÆ ... ..	64	<i>hedleyi</i> ... ..	282
CHEILOBRANCHUS <i>aptenodytum</i> ... ..	196	<i>huxleyi</i> ... ..	282
<i>dorsalis</i> ... ..	196	<i>uniforis</i> ... ..	282
<i>rufus</i> ... ..	195	COLLOZOOM ... ..	274
CHELIDONICHTHYS <i>kumu</i> ... ..	75	<i>arcuatum</i> ... ..	278
CHELMONOPS <i>truncatus</i> ... ..	67	<i>armatum</i> ... ..	275
<i>chelopus</i> , CAMPYLOCHIRUS ... ..	187	<i>ovale</i> ... ..	277
<i>chevreuxi</i> , HALACARUS ... ..	162	sp. ( <i>alpha</i> ) ... ..	275
<i>chevreuxi</i> POLYMELA ... ..	162	sp. ( <i>beta</i> ) ... ..	276
CHEYLETIDÆ ... ..	150	COLPOGNATHUS <i>dentex</i> ... ..	61
CHILOBRANCHUS <i>rufus</i> ... ..	195	<i>colubrinus</i> , ARIAMNES ... ..	24
CHILODACTYLUS <i>nigricans</i> ... ..	63	<i>columba</i> , RHYNCHOPRION ... ..	163
CHILOSTOMELLA <i>oroidea</i> ... ..	307	COLUMBARIUM <i>pagodoidea</i> ... ..	213, 285
<i>chinensis</i> , BALISTES... ..	79	COLUMBELLA <i>alba</i> ... ..	298
<i>chinensis</i> , MONACANTHUS ... ..	79	<i>angasi</i> ... ..	285
CHIONE <i>despecta</i> ... ..	41, 285	<i>pleca</i> ... ..	285
<i>chiragicus</i> PROTOLICHUS ... ..	183	<i>columnella</i> , CUVIERINA ... ..	213, 286
<i>chiragicus</i> , PTEROLICHUS ... ..	183	<i>colurnus</i> , HEMITHYRIS 4t ... ..	214, 286
CHIRONEMUS <i>maculosus</i> ... ..	63	<i>commensalis</i> , MELANELLA ... ..	42
CHLAMYDODERA <i>maculata</i> ... ..	340	<i>communis</i> , var. <i>equi</i> , PSOROPTES ... ..	191
CHLAMYS <i>aspermus</i> ... ..	213	<i>communis</i> , SARCOPTES ... ..	189
<i>hedleyi</i> ... ..	285	<i>compacta</i> , LIOTIA ... ..	42
CHORIOPTES <i>ovis</i> ... ..	191	<i>complanata</i> , ORBITOLITES ... ..	306
<i>symbiotes</i> , var. <i>ovis</i> ... ..	191	<i>compressus</i> , PLATYOTROCHUS ... ..	272
<i>chulus</i> , PACHYDOMELLA ... ..	325	<i>concentrica</i> , CUNA ... ..	42, 286
<i>chrysoptania</i> , LUTIANUS ... ..	62	<i>concinna</i> , CROSSEA ... ..	286
<i>chrysoptania</i> , MESOPRION ... ..	62	<i>concinna</i> , TETRAGNATHA ... ..	332
CICHOPEUS <i>filamentosus</i> ... ..	62	<i>concolor</i> , APONEMMA ... ..	169
<i>lineatus</i> ... ..	63	<i>coniferus</i> , LÆLAPS ... ..	172
<i>cinctata</i> , TRIGONIA ... ..	322	CONOPORA <i>tenuis</i> ... ..	41
<i>cinnabarinus</i> var. TETRANCHUS <i>telarius</i> ... ..	153	<i>constricta</i> , TURBONILLA ... ..	214
CIRSONELLA <i>weldii</i> ... ..	41, 285	COPIDOGNATHUS <i>lamellosus</i> ... ..	163
CYTHNA <i>angulata</i> ... ..	285, 291	<i>pulcher</i> ... ..	163
<i>citreogularis</i> , PHILEMON ... ..	341	Coprolites, Lower Cretaceous ... ..	317
CLADORHYNCHUS <i>leucocephalus</i> ... ..	343	CORALLIOPHILA <i>lischkeana</i> ... ..	219, 285
CLATHURELLA <i>sculptor</i> ... ..	298	<i>corbiensis</i> , AVICULA... ..	320
CLEIDOPUS <i>gloria-maris</i> ... ..	60	<i>corbiensis</i> , MACCOVELLA ... ..	320
CLIO <i>acicula</i> ... ..	285	CORBULA <i>super-concha</i> ... ..	324
<i>pyramidata</i> ... ..	213, 285	CORIAREUS ... ..	301
<i>subula</i> ... ..	213, 285	<i>semiradiatus</i> ... ..	286
<i>virgula</i> ... ..	213, 285	<i>siprens</i> ... ..	286, 301
CLUPANODON <i>neopilchardus</i> ... ..	58	CORNUSPIRA <i>involutens</i> ... ..	306
CLUPEA <i>neopilchardus</i> ... ..	58	<i>coronata</i> , var. <i>nigra</i> , GOURA ... ..	230
CNEMIDOCOPTES <i>mutans</i> ... ..	190	<i>corrugata</i> , DIMYA ... ..	42, 286
COCCULINA <i>coercita</i> ... ..	285, 289	<i>corrugata</i> , MYDORA ... ..	301
<i>meridionalis</i> ... ..	215	<i>corymbophorus</i> , ALLOPTES ... ..	186
		COSSYPHUS <i>culpinus</i> ... ..	70

	PAGE		PAGE
<i>costata</i> , CRISTELLARIA ...	308	CYLICHA <i>tenuis</i> ...	54
<i>costatus</i> , DIPLOCREPIS ...	203, 205	<i>thelidis</i> ...	213
<i>coloneastri</i> , PHYTOPHUS ...	192	<i>cylindrica</i> , TETRAGNATHA ...	332, 333
<i>coxi</i> , DRILLIA ...	213	CYMATIUM <i>kampyla</i> ...	213, 219, 286
CRASSATELLITES <i>discus</i> ...	286, 300	CYNOGLOSSUS <i>broadhursti</i> ...	73
<i>securiforme</i> ...	42, 286, 301	CYPRÆA <i>arellanoides</i> ...	293
<i>crassior</i> , var., PROTOLICHUS		CYPRINA <i>moorei</i> ...	326
<i>brachiatus</i> ...	183	sp. ...	326
<i>crassior</i> var., PTEROLICHUS		CYRILLA <i>dalli</i> ...	213, 286
<i>brachiatus</i> ...	183	CYTHEREA <i>moorei</i> ...	326
<i>cratericula</i> , MARGINELLA ...	214		
<i>crebriplicata</i> , DAPHNELLA ...	286	D	
CRENIDENS <i>tephraeops</i> ...	63	DACRYDIUM <i>fabale</i> ...	286
<i>erenuclatus</i> , HOLCOTROCHUS	272	<i>daintreei</i> , GRAMMATODON ...	322
CREPIDOGASTER ...	315	<i>dalli</i> , CYRILLA ...	213, 286
<i>spatula</i> ...	201	DAMPERIA <i>lineata</i> ...	63
<i>crepidula</i> , CRISTELLARIA ...	308	DAPHNELLA <i>bitorquata</i> ...	298
<i>cretacea</i> , GLOBIGERINA ...	309	<i>crebriplicata</i> ...	286
<i>cretacea</i> , ODONTOSTOMIA ...	329	<i>sculptior</i> ...	286, 298
<i>crispa</i> , POLYTOMELLA ...	310	<i>tasmanica</i> ...	286
<i>cristata</i> , AMPHISILE ...	60	<i>vestalis</i> ...	213, 286
CRISTELLARIA <i>calcar</i> ...	305, 308	<i>dasyuri</i> , STEPHANOCIRCUS ...	107
<i>costata</i> ...	308	Datolite, Colebrook Mine,	
<i>crepidula</i> ...	308	Dundas, Tasmania ...	142
<i>haswelli</i> ...	308, 310	<i>dauidis</i> , TUBIFEX ...	252
<i>orbicularis</i> ...	308	<i>decorata</i> , MATHILDA ...	42, 214, 287
Crocoite, Magnet Mine, Tas-		<i>decorosa</i> , PRONUCULA ...	288
mania ...	141	<i>decorosum</i> , APONOMMA ...	168
CROSSEA <i>carinata</i> ...	42, 286	<i>decorosus</i> , IXODES ...	168
<i>concinna</i> ...	286	DELIOCHUS <i>zelivira</i> ...	335
<i>naticoides</i> ...	286, 290	DELPHINULA <i>sturti</i> ...	327
<i>crossi</i> , DRILLIA ...	213	<i>delta</i> , CUNA ...	213, 286
CRYPTOPORA <i>brazieri</i> ...	286	DELTOCYATHUS <i>rotæformis</i> ...	272
CRENOPSYLLUS <i>musculi</i> ...	109	<i>demissa</i> , PUNCTURELLA ...	288, 289
<i>cucumeris</i> , TETRANYCHUS ...	154	<i>demissa</i> , TETRAGNATHA ...	332
<i>cultriventris</i> , PSEUDALOPTES	185	DENTALIUM <i>erectum</i> ...	42, 213, 286
<i>cultriventris</i> , PTEROLICHUS	185	<i>lubricatum</i> ...	286
<i>cumberlandensis</i> , ATAX ...	160	<i>denter</i> , COLPOGNATHUS ...	61
CUNA <i>concentrica</i> ...	42, 286	<i>denter</i> , PLECTROPOMA ...	61
<i>delta</i> ...	213, 286	<i>denticulata</i> var., SPIRILLINA	
<i>particula</i> ...	42, 286	<i>limbata</i> ...	309
<i>curialis</i> , TURRITELLA ...	357	<i>denticulatus</i> , MACROURUS ...	346
CUSPIDARIA <i>alveata</i> ...	362	<i>denticulatus</i> , OPTONURUS ...	346
<i>angasi</i> ...	213	<i>depressus</i> , ANISOMYON ...	328
<i>brazieri</i> ...	286	<i>depressus</i> , GOBIUS ...	200
<i>latesulcata</i> ...	286	DERMANYSSIDÆ ...	173
<i>truncata</i> ...	47	DERMANYSSUS <i>avium</i> ...	174
CUVIERINA <i>columnella</i> ...	213, 286	<i>galline</i> ...	174
<i>cyanomelas</i> , OLISTHOPS ...	71	DERMATODECTES <i>equi</i> ...	191
<i>cyanotis</i> , ENTOMYZA ...	341	DERMODECIDÆ ...	192
CYCLOSTREMA <i>inscriptum</i> ...	42, 286	DERMODEX <i>folliculorum</i> ...	192
<i>johnstoni</i> ...	213, 216, 286	<i>folliculorum</i> , var. <i>homi-</i>	
<i>micron</i> ...	42	<i>inis</i> ...	193
CYLICHA <i>arachis</i> ...	286	<i>hominis</i> ...	193
<i>ordinaria</i> ...	213		
<i>protumida</i> ...	42, 213, 286		



	PAGE		PAGE
DERMODICOIDEA	148	ECTORISMA <i>granulata</i>	213, 302
<i>despecta</i> , CHIONE	41, 285	ECTATOSTICA <i>trogodytes</i>	338
<i>derisi</i> , OPHIOCLINUS	209	<i>cinetum</i> , APONOMMA	169
<i>derisi</i> , SCLEROPTERYX	209	<i>echinata</i> , TRUNCATULINA	309
<i>devotus</i> , CAPULUS	11, 213, 285	ECHIDNOPAHAGA <i>ambulans</i>	101
DIAPROCORUS	26	<i>edwardsi</i> , NEPHILA	336
<i>multipunctatus</i>	26	<i>elastica</i> (var.) HIPPOSPONGIA	
<i>dilecta</i> , CARDITA	41	<i>equina</i>	119
<i>dilecta</i> , DRILLIA	42, 286	<i>elegans</i> , EURYOPSIS	26
<i>dilecta</i> , EMARGINULA	42	<i>elegans</i> , POROCIDARIS	271, 345
<i>dilecta</i> , NUCULA	362	<i>elegans</i> , PSEUDORISSOINA	51
<i>dilecta</i> , VENERICARDIA	289	<i>elegantula</i> , RISSOINA	288
DIPIYA, <i>corrugata</i>	42, 286	ELEGINUS <i>bursinus</i>	39
DIPLOCREPIS <i>cardinalis</i>	204, 205	<i>ellipticum</i> , RHIPISTOMA	165
<i>costatus</i>	203, 205	<i>ellipticus</i> , RHIPICEPHALUS	165
<i>parripianis</i>	202, 205	<i>elongatus</i> , MYXUS	60
<i>panicus</i>	205	ELOPS <i>sacrus</i>	58
<i>dipsacoides</i> , ARCUCLARIA	359	EMARGINULA <i>dilecta</i>	42
DIPULUS	77	<i>superba</i>	214, 216, 286
<i>cæcus</i>	78	<i>emina</i> , MANGELIA	53, 214, 287
<i>discoidalis</i> , PULTEA	180	<i>ensiculatus</i> , POROLEDA	214, 288
DISCORBINA <i>aracana</i>	309	ENTELEGYNÆ	330
<i>bertheloti</i>	309	<i>entomophagus</i> , TYROGLYPHIUS	180
<i>biconcava</i>	309	EXTOMOPHILA <i>picta</i>	340
<i>prisiensis</i>	309	EXTOMYZA <i>cyanotis</i>	341
<i>vesicularis</i>	309	EPEIRA <i>græffei</i>	335
sp.	309	<i>melanota</i>	335
<i>discus</i> , CRASSATELLITES	286, 300	<i>melanopygia</i>	335
<i>discus</i> , LEPTOPENUS	272	EPEIRIDÆ	330
<i>distincta</i> , SCALA	288	EPHIPPIUS <i>multifasciatus</i>	66
<i>dolichanthus</i> , LELAPS	172	EPIGRUS <i>schævus</i>	286
<i>domesticus</i> , ACARUS	181	EPINEPHELUS <i>fasciatus</i>	61
<i>domesticus</i> , GLYCIPIHAGUS	181	EPISINTUS	25
<i>dorsalis</i> , CHEILOBRANCHIUS	196	<i>australis</i>	25
DRILLIA <i>cori</i>	213	EPITONIUM <i>bellicosum</i>	360
<i>crossi</i>	213	<i>equi</i> , DERMATODECTES	191
<i>dilecta</i>	42, 286	<i>equi</i> , PSOROPTES	191
<i>haswelli</i>	286, 297	<i>equi</i> , SARCOPTES	189, 191
<i>legrandi</i>	298	<i>equi</i> (var.), PSOROPTES <i>communis</i>	191
<i>multilirata</i>	286	<i>equi</i> (var.), PSOROPTES <i>longirostris</i>	191
<i>nenia</i>	42, 286	<i>equi</i> (var.), SARCOPTES <i>scabei</i>	189
<i>pentagonalis</i>	286, 298	<i>equina</i> (var.), <i>elastica</i> , HIPPOSPONGIA	119
<i>tricarinata</i>	213, 286	<i>equina</i> (var.) <i>meandriniformis</i> , HIPPOSPONGIA	120
<i>woodsii</i>	213	<i>erectum</i> , DENTALIUM	42, 213, 286
<i>dringii</i> , JULIS	71	<i>erectus</i> , LIMOPSIS	214, 224
<i>dugesi</i> , IXODES	166	ERIOPHES <i>pyri</i>	192
Dugong bones on the coast of New South Wales	17	ERIOPHYES <i>pyri</i>	192
<i>duploensis</i> , MODIOLA	322	ERIOPHYIDÆ	191
DUNOCYATHUS <i>parasiticus</i>	272	ERYNETES <i>limacum</i>	150
		EUCHELUS <i>scabriusculus</i>	286
		EUCTA <i>anguilla</i>	332
		<i>caudifera</i>	332

## E

EDOLISOMA *tenüirostre* ... 340  
*edelenis*, LABRICHTHYS ... 69

	PAGE		PAGE
EUFREYANA <i>tarandus</i> ...	182	<i>fragilissima</i> , SPIROLOCULINA ...	306
EULIMA <i>fricata</i> ...	286, 290	FREYANA <i>caput-medusæ</i> ...	182
EULIMELA <i>turrita</i> ...	42	<i>tarandus</i> ...	182
EUPHAUSIA <i>pellucida</i> ...	119	<i>fricata</i> , EULIMA ...	286, 290
EUPODIDÆ ...	150	FRONDICULARIA, sp ...	308
EUPODOIDEA ...	149, 150	<i>fronto</i> , PATECUS ...	75, 76, 77
EUPTEROLICHUS <i>ornatus</i> ...	183	<i>furcifera</i> , CAMPAGES ...	43
<i>phyloproctus</i> , var. <i>minor</i> ...	183	<i>fusca</i> , ATLANTA ...	285
EURYOPIS ...	25	<i>fusca</i> , PSAMOSPIHERA ...	307
<i>elegans</i> ...	26	<i>fuscocapitulum</i> , BITTIUM ...	217
<i>umbilicata</i> ...	26		
EUSPONGIA <i>illawarra</i> ...	119	G	
EUTHRIA <i>tabida</i> ...	214, 286	<i>gabrielii</i> , OPHIOCLINUS ...	208
<i>excavata</i> , SPIROLOCULINA ...	306	GAFRARIUM <i>angasi</i> ...	286
<i>exigua</i> , PLANISPIRINA ...	306	<i>galii</i> , PSEUDOMONACANTHUS ...	79
<i>exigua</i> , PSEUDORISSOINA ...	42	<i>galline</i> , ACARUS ...	174
<i>extranea</i> , SMARIDIA ...	155	<i>galline</i> , DERMANYSSUS ...	174
<i>exuleerans</i> , ACARUS ...	189	GAMASIDÆ ...	171
EYLAIIS <i>maccullochi</i> ...	159	GAMASOIDEA ...	149, 171
		GAMASUS <i>flavolimbatus</i> ...	173
F		GANORHYNCHUS <i>strassmilchii</i> ...	129
<i>fabale</i> , DACRYDIUM ...	286	GAUDRYINA <i>subrotundata</i> ...	307
<i>faleuliger</i> , PROTOLICHUS ...	184	<i>geminatum</i> , SPHEROZOUM ...	281
<i>faleuliger</i> , PTEROLICHUS ...	184	<i>gemmata</i> , TETRAGNATHA ...	332
<i>farinea</i> , ALEUROBIUS ...	180	<i>georgianus</i> , SCORPIS ...	64
<i>fasciata</i> , PERCA ...	61	<i>gibbosa</i> , CAVOLINIA ...	213
<i>fasciatus</i> , CÆLORHYNCHUS ...	348, 355	<i>gigas</i> , MUREX ...	99
<i>fasciatus</i> , EPINEPHELUS ...	61	Gilbert, John ...	125
<i>fasciatus</i> , MACRURUS ...	348	Glauberite, pseudomorphs	
<i>fasciatus</i> , PTFLEX ...	103	after, White Cliffs ...	34
FASCINUS <i>typicus</i> ...	286	Glaucinite casts of Foraminifera ...	305
<i>fastosa</i> , PLEUROTOMELLA ...	288, 295	GLOBIGERINA <i>æquilateralis</i> ...	309
<i>favetti</i> , PROTOLICHUS ...	184	<i>bulloides</i> ...	305, 309
<i>favetti</i> , PTEROLICHUS ...	184	<i>bulloides</i> , var. <i>triloba</i> ...	309
FEDRIZZIA <i>grossipes</i> ...	175	<i>cretacea</i> ...	309
<i>ferox</i> , TETRAGNATHA ...	332	<i>limbata</i> ...	309
<i>ferruginea</i> , STIVA ...	288	sp. ...	309
<i>filamentosus</i> , CICHLOPS ...	62	<i>globosa</i> , LAGENA ...	305, 308
<i>filamentosus</i> , HETEROSCARUS ...	71	<i>globularis</i> , COLLOSPIHERA ...	282
<i>filiformis</i> , NODOSARIA ...	308	<i>gloria-maris</i> , CLEIDOPTUS ...	60
<i>filocincta</i> , RISSOA ...	214, 217, 288	<i>gloria-maris</i> , MONOCENTRIS ...	60
Fish-fry killed by UTRICULARIA ...	3	<i>gloriosa</i> , BRYOBIA ...	152
Fish-fry, retarded growth of ...	4	GLYCIPHAGUS <i>domesticus</i> ...	181
FLABELLUM <i>australe</i> ...	272	<i>runorum</i> ...	181
sp. ...	272	GLYPHIDODON <i>australis</i> ...	69
<i>flavolimbatus</i> , GAMASUS ...	173	<i>brownriggii</i> ...	69
<i>flesoides</i> , RHOMBOSOLEA ...	197	GLYPHISODON <i>biocellatus</i> ...	68, 69
<i>flindersi</i> , MITROMORPHA ...	298	<i>brownriggii</i> ...	68
<i>fulvicolorum</i> , ACARUS ...	192	<i>glyptus</i> , ASTELE ...	213
<i>fulvicolorum</i> , DERMODEX ...	192	GOBIESOX <i>cardinalis</i> ...	205
<i>fulvicolorum</i> , var. <i>hominis</i> , DERMODEX ...	193	GOBIUS <i>depressus</i> ...	200
sp. ...	193	<i>mucosus</i> ...	200
<i>fortis</i> , LEDA ...	362	<i>godeffroyana</i> , TURRITELLA ...	214

	PAGE
<i>goldsteini</i> , TROPHON ...	288
<i>GOURA coronata</i> , var. <i>nigra</i> ...	230
<i>gracilis</i> , MICROMERYS ...	23
<i>gracilis</i> , OPHIOCLINUS ...	207
<i>graeffei</i> , EPEIRA ...	335
<i>graeffei</i> , META ...	335
<i>graeffei</i> , PHONOGNATHA ...	335
<i>grallarius</i> , EDICNEMUS, eggs of	315
GRAMMATODON <i>daintreei</i> ...	322
<i>granulata</i> , ARGYROPEIRA ...	335
<i>granulata</i> , ECTORISMA ...	213, 302
<i>granulatus</i> , BALISTES ...	80, 210
<i>granulatus</i> , PSEUDOMONACANTHUS ...	80, 210
<i>granulosissima</i> , MANGELIA ...	287
<i>gregaria</i> , SPIRULÆA ...	318
<i>grosserugosa</i> , ANOMALINA ...	309
<i>grossipes</i> , FEDRIZZIA ...	175
<i>guentheri</i> PSEUDOLABRUS ...	70
GYMNODACTYLUS <i>louisianensis</i> ...	13
<i>olivi</i> ...	14
GYMNOTHORAX <i>punctatofasciatus</i> ...	58

## H

HEMAPHYSALIS <i>leachi</i> ...	165
<i>longicornis</i> ...	16
<i>micropola</i> ...	166
<i>papuanu</i> ...	165
<i>rosea</i> ...	166
HALACARIDÆ ...	161
HALACARUS <i>chevreuxi</i> ...	162
<i>hispidus</i> ...	162
<i>lamellosus</i> ...	163
<i>oblongus</i> ...	162
<i>panopæ</i> ...	162
<i>panopæ</i> , var. <i>squamifera</i> ...	162
<i>pulcher</i> ...	163
<i>halligani</i> , CERITHIOPSIS ...	51
<i>hamiltoni</i> , SPHEROIDES ...	210
HARPE <i>vulpina</i> ...	70
<i>hasseltii</i> , LATRODECTUS ...	28
<i>hasta</i> , LUTJANUS ...	63
<i>hasta</i> , POMADASIS ...	63
HASTIGEBINA <i>pelagica</i> ...	309
<i>haswelli</i> , CRISTELLARIA ...	308, 310
<i>haswelli</i> , DRILLIA ...	286, 297
<i>haswelli</i> , HOPLICHTHYS ...	351
<i>hedleyi</i> , CHLAMYS ...	285
<i>hedleyi</i> , COLLOSPHERA ...	281

	PAGE
HELICOLENUS <i>percoides</i> ...	350
HEMITHYRIS <i>colurnus</i> 44, 214, ...	286
HETERACTITIS <i>brevipes</i> ...	343
HETEROPUS <i>alastoris</i> ...	177
HETEROSCARUS <i>filamentosus</i> ...	71
Heulandite, Werris Creek, N.S. Wales ...	422
<i>hexagona</i> , var. <i>lata</i> , LAGENA ...	308
<i>hilli</i> , BELONZOZOM ...	279
<i>hilli</i> , CERATOPHYLLUS ...	103
<i>hippocrepis</i> , BALISTES ...	80
<i>hippocrepis</i> , PSEUDOMONACANTHUS ...	80
HIPPOSPONGIA <i>equina</i> , var. <i>elastica</i> ...	119
<i>equina</i> var. <i>meandriformis</i> ...	120
sp. ...	120
<i>hispidus</i> , HALACARUS ...	162
<i>hispidus</i> , TETRAODON ...	210
<i>hispidus</i> , POLYMELA ...	162
HISTIOPTERUS <i>recurvirostris</i> ...	62
HOLCOTROCHUS <i>crenulatus</i> ...	272
HOLOCENTRUM <i>rubrum</i> ...	60
HOLOCENTRUS <i>calcarifer</i> ...	62
<i>holocyclus</i> , IXODES ..	167
<i>hominis</i> , DERMODEX ...	193
<i>hominis</i> var., DERMODEX <i>folliculorum</i> ...	193
<i>hominis</i> , SARCOPTES ...	189
<i>hominis</i> var., SARCOPTES <i>scabiei</i> ...	189
HOPLICHTHYS <i>haswelli</i> ...	351
HOPLOCEPHALUS <i>bitorquatus</i> ...	38
<i>hungaroides</i> ...	38
<i>stephensii</i> , climbing habits of ...	38
<i>horrida</i> , SCORPENA ...	74
<i>horridum</i> , SYNANCIIDIUM ...	74
<i>hughendenensis</i> , AVICELLA ...	321
<i>hughendenensis</i> , AVICULA ...	321
<i>humeralis</i> , TERAPON ...	62
<i>humeralis</i> , THERAPON ...	62
<i>huxleyi</i> , COLLOSPHERA ...	282
HYDATINA <i>tasmanica</i> ...	286
HYRACHINA <i>odontognathus</i> ...	160
HYDRACHNIDÆ ...	159
HYDRACHNOIDEA ...	149, 159
<i>hydrosauri</i> , AMBLYOMMA ...	169
<i>hydrosauri</i> APONOMMA ...	169
<i>hydrosauri</i> , IXODES ..	169
HYLIDÆ, retarded growth of tadpole of ...	4
HYPERAMMINA <i>vaganus</i> ...	307
HYPOCHILIDÆ ...	338
HYPSPIDOPS ...	69
<i>microlepis</i> ...	67

	PAGE		PAGE
ICHTHYODECTES <i>marathonensis</i> ...	8	<i>kampyla</i> , NASSARIA ...	219
<i>identatus</i> , IXODES ...	166	<i>kemb lensis</i> , MARGINELLA ...	295
<i>illawarra</i> , EUSPONGIA ...	119	<i>kerandrenii</i> , ATLANTA ...	299
<i>impressa</i> , SPIROLOCULINA ...	306	<i>kerandrenii</i> , OXYGYRUS ...	287, 299
<i>incanus</i> , TOTANUS ...	343	KNEMIDOKOPTES <i>viriparus</i> ...	190
<i>incisa</i> , TURRITELLA ...	214	<i>kumu</i> , CHELIDONICHTHYS ...	75
<i>incisifrons</i> , ARGYRODES ...	25	<i>kumu</i> , TRIGLA ...	75
<i>incisus</i> , BUCCINUM ...	99		
<i>inclinata</i> , ATLANTA ...	285	L	
<i>incommoda</i> , BULLA ...	213, 285	<i>labiosus</i> CATULUS ...	57
<i>inconstans</i> , OPHTHALMIDIUM ...	307	LABRICHTHYS <i>hastockii</i> ...	70
<i>induta</i> , LUCINA ...	363	<i>edelensis</i> ...	69
<i>inflata</i> , LIMACINA ...	287	<i>punctulata</i> ...	69
<i>inflata</i> , CAVOLINIA ...	213, 285	LABRUS <i>tetricus</i> ...	70
<i>innotabilis</i> , CÆLORHYNCHUS ...	348	<i>lactea</i> , ROCHEFORTIA ...	214, 288
<i>inopinata</i> , LEDA ...	214	LÆLAPS <i>coniferus</i> ...	173
<i>inornata</i> , PHILOBRYA ...	288	<i>dolichanthus</i> ...	172
<i>inscriptum</i> , CYCLOSTREMA ...	42, 286	<i>stilosus</i> ...	172
<i>insculpta</i> , CARETTOCHELYS ...	110	<i>lævigata</i> , MARGINELLA ...	42, 214, 287
<i>insperatus</i> , CACOMANTIS, eggs of ...	423	LAGENA <i>globosa</i> ...	305, 308
<i>integella</i> , RISSOA ...	288	<i>hexagona</i> , var. <i>lata</i> ...	308
<i>integra</i> , TURQUETIA ...	364	<i>orbignyana</i> ...	307
<i>intermedius</i> , TRACHICHTHYS ...	349	<i>plumigera</i> ...	307
<i>involutus</i> , CORNUSPIRA ...	306	<i>squamosa-marginata</i> ...	307
<i>ischnus</i> , EPIGRUS ...	286	<i>striata</i> ...	308
ISOTOMA <i>troglydytica</i> ...	313	<i>sulcata</i> ...	305, 307
IXODE ...	187	<i>sulcata</i> , var. <i>annularis</i> ...	307, 311
IXODES <i>horis</i> ...	166	LAMBRUS <i>validus</i> ...	231
<i>decorosus</i> ...	168	<i>lamellosus</i> , COPIDOGNATHUS ...	163
<i>dugesii</i> ...	166	<i>lamellosus</i> , HALACARUS ...	163
<i>halocyclus</i> ...	167	<i>laminatus</i> , TROPHON ...	214, 288
<i>hydrosauri</i> ...	169	LAMPUSIA <i>nodocostata</i> ...	219
<i>identatus</i> ...	166	<i>lata</i> var., LAGENA <i>hexagona</i> ...	308
<i>ornithorhynchi</i> ...	167	LATES <i>calcarifer</i> ...	62
<i>tasmani</i> ...	167	<i>latesulcata</i> , CUSPIDARIA ...	286
<i>trimaculatus</i> ...	168	LATREILLOPSIS <i>petterdi</i> ...	353
<i>varani</i> ...	168	LATROBECTUS ...	28
IXODIDE ...	165	<i>hasseltii</i> ...	28
IXODOIDEA ...	149, 163	<i>scelio</i> ...	28
J		<i>lauretance</i> , TEREBRA ...	214, 222
<i>jacksonensis</i> , NASSA ...	214, 287, 359	<i>leachi</i> , HEMAPHYSALIS ...	165
JANULUS ...	25	<i>leachi</i> , RHIPIDOSTOMA ...	165
<i>bicornis</i> ...	25	<i>leachi</i> , RHIPIDOSTOMA ...	165
<i>johnstoni</i> , CYCLOSTREMA ...	213, 216	LEDA <i>fortis</i> ...	362
<i>jukesiana</i> , SCALA ...	288	<i>inopinata</i> ...	214
JULIS <i>dringii</i> ...	71	<i>miliacea</i> ...	42, 214, 287
<i>lineolatus</i> ...	70	<i>pala</i> ...	361
		<i>ramsayi</i> ...	214
K		<i>legrandi</i> , DRILLIA ...	298
<i>kampyla</i> , CYMATIUM ...	213, 219, 286	LEIOSTRACA <i>lodderæ</i> ...	42
		LEISOMA, sp. ...	176
		<i>lenticularis</i> , ARACANA ...	82
		<i>lenticularis</i> , OSTRACION ...	82

	PAGE		PAGE
LEPIDOGASTER <i>puniceus</i> ...	205	<i>longicornis</i> , HEMAPHYSALIS ...	165
LEPTOPENUS <i>discus</i> ...	272	<i>longirostris</i> , CAVOLINIA ...	213
<i>lepturus</i> , PILETON ...	343	<i>longirostris</i> , var. <i>angulata</i> , CAVOLINIA ...	285
LEPTUS larvæ ...	158, 159	<i>longirostris</i> , var. <i>equi</i> , PSOROP- TES ...	191
<i>leucocephalus</i> , CLADORHYNCHUS	343	<i>longirostris</i> , var. <i>strangulata</i> , CAVOLINIA ...	285, 299
LEUCOTINA <i>micra</i> ...	42	LOTORIUM <i>nodocostatum</i> ...	219
<i>levifoliata</i> , SCALA ...	288, 290	<i>louisianensis</i> GYMNO DACTYLUS	13
Lewin, John William ...	121	<i>lubricatum</i> , DENTALIUM ...	286
LIACARUS, sp. ...	176	LUCINA <i>induta</i> ...	363
<i>licinus</i> , MUREX ...	214, 219	<i>lanula</i> , PROTOLICHUS ...	183
<i>ligata</i> , OSCILLA ...	42	<i>lanula</i> , PTEROLICHUS ...	183
LIMA <i>bassi</i> ...	287	<i>lapata</i> , TETRAGNATHA ...	332
<i>bullata</i> ...	42, 287	<i>lutaria</i> , MANGELIA ...	287, 296
<i>murrai</i> ...	223	LUTIANUS <i>chrysotaenia</i> ...	62
LIMACINA <i>inflata</i> ...	287	LUTIANUS <i>hasta</i> ...	63
<i>limacum</i> , ACARUS ...	150	<i>lutuberculata</i> , TETRAGNATHA	332
<i>limacum</i> , ERYNETES ...	150	LYONSIELLA <i>quadrata</i> ...	287, 302
<i>limbata</i> , SPIRILLINA ...	309		
<i>limbata</i> , var. <i>denticulata</i> , SPIRILLINA ...	309	M	
<i>limbata</i> , SPIROLOCULINA ...	306	MACCOYELLA <i>corbiensis</i> ...	320
<i>limbatum</i> , AMBLYOMMA ...	170	<i>maccullochi</i> , CHÆTODERMIS	81
LIMEA <i>acelinis</i> ...	46, 223	<i>maccullochi</i> , EYLAI ...	159
<i>murrayi</i> ...	214, 223, 287	<i>macella</i> , POLYSTOMELIA	306, 310
LIMOPSIS <i>brazieri</i> ...	287	MACROGASTER <i>platypus</i> ...	193
<i>erectus</i> ...	214, 224	MACROPODUS <i>viridicauratus</i>	1
<i>tenisoni</i> ...	42, 214, 287	MACRORUS <i>denticulatus</i> ...	346
<i>linea</i> , MODIOLA ...	287, 300	<i>nigromaculatus</i> ...	346
<i>lineata</i> , DAMPERIA ...	63	<i>macrurus</i> , CHARCHARIAS ...	226
<i>lineatus</i> , CICHLOPS ...	63	MACRURUS <i>fasciatus</i> ...	348
<i>lineolatus</i> , JULIS ...	70	MACTRA <i>trigonalis</i> ...	326
<i>lineolatus</i> , OPIETHALMOLEPIS	70	<i>maculata</i> , CHLAMYDODERA ...	340
<i>linneana</i> , GLOBIGERINA ...	309	<i>maculata</i> , NEPHILA ...	336
LINYPHIA <i>melanozantha</i> ...	331	<i>maculatus</i> , PATECUS ...	75, 77
<i>nitens</i> ...	331	<i>maculosus</i> , CHIRONEMUS ...	63
<i>quindecim-punctata</i> ...	331	<i>maculosus</i> , THREPTERIUS ...	63
<i>sublutea</i> ...	331	<i>maguirostris</i> , MELITHREPTUS	20
LINYPHINE ...	330	<i>major</i> , ALLOPTES ...	186
LIOTHYRIS <i>ura</i> ...	43	MANGELIA <i>emina</i> ...	53, 214, 287
LIOTIA <i>alazon</i> ...	49	<i>granulosissima</i> ...	287
<i>annulata</i> ...	42	<i>lutaria</i> ...	287, 296
<i>capitata</i> ...	357	<i>spica</i> ...	287, 297
<i>compacta</i> ...	42, 287	<i>watsoni</i> ...	214
<i>minima</i> ...	42, 287	<i>manicatus</i> , PTERODECTES	186
<i>tasmanica</i> ...	42	<i>marathonensis</i> , ICHTHYODECTES	8
<i>tasmanica</i> , var. <i>scalaris</i>	287	<i>margaritacea</i> , TRIGONIA ...	288
LIPPISTES <i>lorenzaris</i> ...	287	<i>margaritarius</i> , ARGYRODES	25
<i>lischkeana</i> , CORALLIOPHILA	219, 285	<i>margaritata</i> , TETRAGNATHA	332
<i>lischkeana</i> , RAPANA ...	213, 219	MARGINELLA <i>agapeta</i> ...	214
LISTROPHORIDE ...	187	<i>allporti</i> ...	214, 287, 295
<i>litoralis</i> , PHOLCUS ...	22	<i>angasi</i> ...	42
<i>livens</i> , ANCOCELUS ...	28	<i>brazieri</i> ...	214, 287
<i>lobatata</i> , TRUNCATULINA ...	309		
<i>lobulatus</i> , ALLOPTES ...	185		
<i>loldera</i> , LEOSTRACA ...	42		

	PAGE		PAGE
MARGINELLA <i>cratericula</i> ...	214	MILIOLINA <i>alveoliformis</i> ...	306
<i>kemblensis</i> ...	295	<i>bicornis</i> ...	306
<i>laevigata</i> ...	42, 214, 287	<i>separans</i> ...	306
<i>multiplicata</i> ...	287	<i>trigonula</i> ...	306
<i>mustellina</i> ...	42	<i>milvulina</i> , var. <i>PSEUDALLOP-</i>	
<i>ochracea</i> ...	42, 214, 287	<i>TES aquilius</i> ...	184
<i>simsoni</i> ...	287	<i>milvulina</i> , var. <i>PTEROLICHUS</i>	
<i>stanislaus</i> ...	287	<i>aquilinus</i> ...	184
<i>stilla</i> ...	42, 214, 287	Mimetite, Zeehan, Tasmania ...	189
<i>strangei</i> ...	214, 287	<i>minerva</i> , STEPHANOCIRCUS ...	108
<i>whani</i> ...	42, 287	<i>miniaceum</i> , POLY TREMA ...	310
<i>marmorata</i> , PENTAROGE ...	201	<i>minor</i> var., EUP TEROLICHUS	
<i>marmoratus</i> , APISTUS ...	201	<i>phylloproctus</i> ...	183
<i>mars</i> , STEPHANOCIRCUS ...	108	<i>minor</i> var., PTEROLICHUS	
<i>martius</i> , PANDALUS ...	355	<i>phylloproctus</i> ...	183
<i>martius</i> , PLESIONIKA ...	355	<i>minor</i> , SARCOPTES ...	188
MATHILDA <i>decorata</i> ...	42, 214, 287	<i>minuta</i> , PRONTCULA ...	288
<i>maxilla</i> , THECIDEA ...	45	<i>minutula</i> , ACRILLA ...	52
<i>meandrina</i> , THORECTA ...	120	<i>minutula</i> , SCALA ...	42, 52
<i>meandriniformis</i> , var. HIP-		<i>minutula</i> , SCALARIA ...	52
<i>POSPONGIA equina</i> ...	120	<i>miranda</i> , VULPECULA ...	215
MEGALATRACTUS <i>arvanus</i> ...	98	MISOCALIUS <i>palliolatus</i> ...	342
<i>megalourus</i> , MONACANTHUS ...	79	MITRA <i>scalariformis</i> ...	287
MEGERLIA <i>willemoesi</i> ...	43	<i>strangei</i> ...	42, 287
MELANELLA <i>commensalis</i> ...	42	<i>tasmanica</i> ...	287
<i>melania</i> , EPEIRA ...	335	MITROMORPHA <i>alba</i> ...	287, 298
<i>melania</i> , META ...	335	<i>flindersi</i> ...	298
<i>melania</i> , SINGOTYPNA ...	335	MODIOLA <i>australis</i> ...	287
<i>melanopygia</i> , EPEIRA ...	335	<i>dunlopensis</i> ...	322
<i>melanopygia</i> , SINGOTYPNA ...	335	<i>linea</i> ...	287, 300
<i>melano-antha</i> , LINYPHIA ...	331	MODIOLARIA <i>splendida</i> ...	287
MELITHREPTUS <i>hervirostris</i> ,		MONACANTHUS <i>chinensis</i> ...	79
<i>insular</i> form of ...	20	<i>megalourus</i> ...	79
<i>magnirostris</i> of ...	20	Monazite, The Gulf, N. S.	
<i>menardii</i> , PULVINULINA ...	309	Wales ...	414
<i>meridionalis</i> , COCCULINA ...	215	MONILEA <i>arata</i> ...	214, 287
<i>meridionalis</i> , OMALAXIS ...	287	<i>oleacea</i> ...	214
Mesolite, Ben Lomond, N. S.		<i>oleata</i> ...	215
Wales ...	419	<i>philippensis</i> ...	214, 287
MESOPRION <i>chryso-tenia</i> ...	62	MONOCENTRIS <i>gloria-maris</i> ...	60
META <i>graeffei</i> ...	335	MONTACUTA <i>semiradiata</i> ...	301
<i>melania</i> ...	335	<i>montanus</i> , RHYNCHOLOPHUS ...	155
<i>ornata</i> ...	334	<i>moorei</i> , CYPRINA ...	326
<i>zeliriva</i> ...	335	<i>moorei</i> , CYTHEREA ...	326
MICHELIA <i>caput-medusæ</i> ...	182	<i>morchii</i> , SCALA ...	214
<i>meliniana</i> , PULVINULINA ...	309	<i>morelia</i> , AMBLYOMMA ...	170
<i>micra</i> , CANCELLARIA ...	361	<i>mucosus</i> , GOBIUS ...	200
<i>micra</i> , LECOTINA ...	42	<i>muelleri</i> , PARALICHTHYS ...	73
<i>microlepis</i> , HYSIPOPS ...	67	<i>muelleri</i> , PSEUDOCROMIS ...	62
<i>microlepis</i> , PARMA ...	68, 69	<i>muelleri</i> , PSEUDORHOMBUS ...	73
MICROMERYS ...	23	<i>multifasciatus</i> , EPHIPPUS ...	63
<i>gracilis</i> ...	23	<i>multifasciatus</i> , SCATOPHAGUS ...	66
<i>micron</i> , CYCLOSTREMA ...	42	<i>multilirata</i> , DRILLIA ...	286
<i>micropola</i> , HÆMAPHYSALIS ...	166	<i>multiplicata</i> , MARGINELLA ...	287
<i>miliaea</i> , LEDA ...	42, 214, 287	<i>multipunctatus</i> , DIAPROCORUS ...	26
		MUNIA <i>castaneothorax</i> ...	342

	PAGE
MUREX <i>acanthopterus</i> ... ..	287
<i>gigas</i> ... ..	99
<i>licinus</i> ... ..	219
<i>murrayi</i> , LIMA ... ..	223
<i>murrayi</i> , LIMEA ...214, 223,	287
<i>musculi</i> , CTENOPSISILLUS ...	109
MUS <i>rattus</i> ... ..	312
<i>tompsoni</i> ... ..	312
<i>variabilis</i> ... ..	312
<i>mustellina</i> , MARGINELLA ...	42
<i>mutans</i> , CNEMIDOCOPTES ...	190
<i>mutans</i> , SARCOPTES ... ..	190
MYODORA <i>albida</i> ... ..	287, 301
<i>corrugata</i> ... ..	301
<i>myops</i> , SALMO ... ..	58
<i>myops</i> , TRACHINOCEPHALUS	58
MYXUS <i>elongatus</i> ... ..	60

## N

NACELLA <i>tasmanica</i> ... ..	215
NASSA ... ..	359
<i>jacksonensis</i> ...214, 287,	359
NASSARIA <i>kampyla</i> ... ..	219
<i>naticoides</i> , CROSSEA... ..	286, 290
Natrolite, Inverell, N.S. Wales	420
<i>navus</i> , (ECOBIUS ... ..	11
NEATYPUS ... ..	64
<i>obliquus</i> ... ..	65
<i>nebulosus</i> , PARAFERCIS ... ..	75
<i>nebulosus</i> , PERCIS ... ..	75
<i>nenia</i> , DRILLIA ... ..	42, 286
NEPHILA <i>edwardsi</i> ... ..	336
<i>maculata</i> ... ..	336
<i>ventricosa</i> ... ..	337
NEPHILENGYS <i>rainbowi</i> ... ..	336
NEPHILINÆ ... ..	335
NEOPATECUS... ..	76, 77
<i>neopilchardus</i> , CLUPANODON	58
<i>neopilchardus</i> , CLUPEA ...	58
NEOSEBASTES <i>panda</i> ... ..	74
NERIENE <i>analis</i> ... ..	331
NEZUMIA ... ..	347
<i>nigra</i> var. , GOURA <i>coronata</i>	230
<i>nigricans</i> , CHILODACTYLUS... ..	63
<i>nigromaculatus</i> , MACROURUS	346
<i>nitens</i> , LINYPHIA ... ..	331
<i>nitida</i> , CANDEINA ... ..	309
<i>nitidula</i> , OBELISCUS... ..	217
<i>nitidula</i> , ODOSTOMIA ... ..	217
<i>nitidula</i> , PYRAMIDELLA ... ..	216
<i>nitidula</i> , SYRNOLA ... ..	216
<i>nitidula</i> , TIBERIA ... ..	214, 216
<i>nobilis</i> , BEYOBIA ... ..	152
<i>nodocostata</i> , LAMPUSIA ... ..	219

	PAGE
<i>nodocostatum</i> , LOTORIUM ... ..	219
NODOSARIA <i>filiformis</i> ... ..	308
<i>scalaris</i> ... ..	308
<i>vertebralis</i> ... ..	308
sp. ... ..	308
<i>nodosa</i> , VERMICULARIA £89,	292
<i>notabilis</i> , PHREODRILOIDES	260
NOTEDRUS <i>cati</i> ... ..	188
NOTOEDRES <i>cati</i> ... ..	188
<i>notoedres</i> , var. <i>cati</i> , SARCOPTES	188
NOTOPHYLLIA <i>recta</i> ... ..	272
<i>novariensis</i> , RISSOA... ..	288
NUCULA <i>dilecta</i> ... ..	362
<i>obliqua</i> ... ..	287, 362

## O

OBELISCUS <i>nitidula</i> ... ..	217
<i>obliqua</i> , NUCULA ... ..	287, 362
<i>obliquiloculata</i> , PULLENIA ...	309
<i>obliquus</i> , NEATYPUS... ..	65
<i>oblongus</i> , HALACARUS ... ..	162
<i>obolella</i> , SAREPTA ... ..	288
<i>obtusata</i> , SPHYRENA ... ..	60
<i>ochracea</i> , MARGINELLA 42, 214,	287
ODAX <i>pullus</i> ... ..	71
<i>richardsonii</i> ... ..	71
<i>odontognathus</i> , HYDRACHNA	160
ODONTOSTOMIA <i>cretacea</i> ... ..	329
ODOSTOMIA <i>nitidula</i> ... ..	217
<i>simplex</i> ... ..	287
(ECOBIUS <i>navus</i> ... ..	11
(EDICNEMUS <i>grallarius</i> , eggs of	315
<i>oleacea</i> , MONILEA ... ..	214
<i>oleata</i> , MONILEA ... ..	215
OLISTHOPS <i>cyanomelas</i> ... ..	71
<i>olivacea</i> RISSOA ... ..	42, 288
<i>olivii</i> , GYMNODACTYLUS ... ..	14
OMALAXIS <i>meridionalis</i> ... ..	287
Opal pseudomorphs White	
Cliffs ... ..	81
<i>opercularis</i> , POLYACANTHUS,	
breeding habits of	1
OPERCULINA <i>ammonoides</i> ... ..	310
OPHIOCLINUS ... ..	209
<i>devisi</i> ... ..	209
<i>gabrieli</i> ... ..	208
<i>gracilis</i> ... ..	207
OPHTHALMOLEPIS <i>lineolatus</i>	70
OPHTHALMIDIUM <i>inconstans</i> ...	307
OPTONURUS <i>dentienlatus</i> ... ..	346
<i>opulenta</i> , TURRITELLA 288,	292
<i>orbicularis</i> , CRISTELLARIA ...	308
<i>orbignyana</i> , LAGENA ... ..	307
ORBITOLITES <i>complanata</i> ... ..	306

	PAGE		PAGE
ORBULINA <i>porosa</i> ...	309	PARMA <i>microlepis</i> ...	68, 69
<i>universa</i> ...	309	<i>squamipinnis</i> ...	68, 69
<i>ordinaria</i> , CYLICHNA ...	213	<i>particula</i> , CUNA ...	42, 286
ORIBATIDÆ ...	176	<i>parva</i> , var. <i>tasmanica</i> , ACMEÆA ...	215
ORIBATOIDEA ...	149, 175	<i>parvipinnis</i> DIPLOCREPIS ...	202, 205
<i>ornata</i> , META ...	334	PATÆCUS ...	77
<i>ornatus</i> , EUPTEROLICHUS ...	183	<i>armatus</i> ...	76, 77
<i>ornatus</i> , PTEROLICHUS ...	183	<i>fronto</i> ...	75, 76, 77
<i>ornithorhynchi</i> , IXODES ...	167	<i>maculatus</i> ...	75, 77
Orthoclase, Bolivia, N. S.		<i>subocellatus</i> ...	76, 77
Wales ...	270	<i>vincentii</i> ...	77
Cockburn Creek, N. S.		<i>waterhousii</i> ...	76
Wales ...	265	<i>pectinata</i> , PHILOBRYA ...	288
Inverell, N. S. Wales ...	270	PEDICULOIDES <i>alastoris</i> ...	177
Oban, N. S. Wales ...	266	PEDICULARIA <i>stylasteris</i> ...	42
Uralla, N. S. Wales ...	269	<i>pelagica</i> , HASTIGERINA ...	309
OSCILLA <i>ligata</i> ...	42	<i>pellucida</i> , EUPHAUSIA ...	119
<i>oscitans</i> , PHILINE ...	361	PELTORHAMPHUS <i>bassensis</i> ...	198
OSTRACION <i>auritus</i> ...	82	PENÆUS <i>semisulcatus</i> ...	119
<i>lenticularis</i> ...	82	<i>penicilligerus</i> , BALISTES ...	80
<i>ovale</i> , COLLOZOOM ...	277	<i>penicilligerus</i> , CHÆTODERMIS ...	80
<i>oris</i> , CHORIOPTES ...	191	PENTACEROPSIS <i>recurrostris</i> ...	62
<i>oris</i> var. <i>CHORIOPTES sym-</i>		<i>pentagonalis</i> , DRILLIA ...	286, 298
<i>biotes</i> ...	191	PENTAROSE <i>marmorata</i> ...	201
<i>oroidea</i> , CHILOSTOMELLA ...	307	PERCA <i>fasciata</i> ...	61
OXYGYRUS, <i>kerandrenii</i> ...	287, 299	<i>percoides</i> , HELICOLENUS ...	350
OXYTOMA <i>rockwoodensis</i> ...	321	<i>percoides</i> , SCORPÆNA ...	350
		<i>percoides</i> , SEBASTES ...	350
		PERCIS <i>nebulosus</i> ...	75
		<i>persicus</i> , ARGAS ...	164
		<i>perversidens</i> , BATHYARCA ...	41, 285
		PETROBIA <i>speciosa</i> ...	152
		<i>petterdi</i> , LATREILLOPSIS ...	353
		Petterdi, Britannia Mine,	
		Zeehan, Tasmania ...	137
		PHÆTON <i>lepturus</i> ...	343
		PHILEMON <i>citreoangularis</i> ...	341
		PHILINE <i>oseitans</i> ...	361
		<i>teres</i> ...	288
		<i>trapezia</i> ...	361
		<i>trapezina</i> ...	288
		<i>philippensis</i> , MONILEA ...	214, 287
		<i>philippensis</i> , TURRITELLA ...	214
		<i>philippensis</i> , TYPHIS ...	289
		PHILOBRYA <i>inornata</i> ...	288
		<i>pectinata</i> ...	288
		<i>tatei</i> ...	288
		PHOLCUS ...	22
		<i>litoralis</i> ...	22
		PHONOGNATHA <i>græffei</i> ...	335
		PHREODRILOIDES ...	260
		<i>notabilis</i> ...	260
		PHYLARCHUS ...	26
		<i>splendens</i> ...	26
		<i>phylloproctus</i> , var. <i>minor</i> ,	
		EUPTEROLICHUS ...	183

## P

PACHYDOMELLA ...	325
<i>chutus</i> ...	325
<i>pagodoides</i> , COLUMBARIUM ...	213, 285
<i>pala</i> , LEDA ...	361
<i>palliolatus</i> , MISOCALIUS ...	342
PANDALUS <i>martini</i> ...	355
<i>panda</i> , NEOSEBASTES ...	74
<i>panda</i> , SCORPÆNA ...	74
<i>pandora</i> , RHAPHIDOZOOM ...	280
<i>panope</i> , HALACARUS ...	162
<i>panope</i> , POLYMELA ...	162
<i>panope</i> , var. <i>squamifera</i> ,	
HALACARUS ...	162
<i>papua</i> , HÆMAPHYSALIS ...	165
<i>papuanum</i> , TROMBIDIUM ...	158
<i>papyracea</i> , PSEUDAVICULA ...	319
<i>paradisiacus</i> , PTERODECTES ...	186
PARALICHTHYS <i>muelleri</i> ...	73
PARAPERCCIS <i>nebulosus</i> ...	75
PARASCYLLIUM <i>collare</i> , egg-	
<i>case</i> ...	229
<i>parasiticus</i> , DUNOCYATHUS ...	272
<i>parisiensis</i> , DISCORBINA ...	309
PARMA ...	69



	PAGE		PAGE
<i>phylloproctus</i> , var. <i>minor</i> , ...		PROTALGES <i>australis</i> ...	185
<i>UTEROLICHUS</i> ...	183	<i>cartus</i> ...	185
PHYTOPHAGUS <i>arianus</i> ...	192	<i>protensa</i> , TETRAGNATHA ...	332
<i>aronia</i> ...	192	PROTOLICHUS <i>affinis</i> ...	184
<i>cotoneastri</i> ...	192	<i>brachiatus</i> var. <i>crassior</i> ...	183
<i>pyri</i> ...	192	<i>chiragicus</i> ...	183
<i>sorbi</i> ...	192	<i>falculiger</i> ...	184
<i>picta</i> , ENTOMOPHILA ...	340	<i>favettei</i> ...	184
<i>piri</i> , ERIOPHYTES ...	192	<i>lunula</i> ...	183
PLANISPIRINA, sp. ...	306	<i>velifer</i> ...	184
<i>exigua</i> ...	306	<i>protumida</i> , CYLICHNA 42, 213, ...	286
PLANORBULINA sp. ...	309	<i>prunorum</i> , GLYCIPIHAGUS ...	181
PLATYTROCHUS <i>compressus</i> ...	272	PSAMMOSPHERA <i>fusca</i> ...	307
<i>platypus</i> , MACROGASTER ...	193	PSEUDALLOPTES <i>equilinus</i> , ...	
PLECTROPOMA <i>dentex</i> ...	61	var. <i>mitraluna</i> ...	184
<i>serratum</i> ...	61	<i>cultri ventris</i> ...	185
PLESIONIKA <i>martius</i> ...	355	<i>spathuliger</i> ...	184
PLEURONECTES <i>victoriae</i> ...	197	PSEUDAPHRITIS <i>bursinus</i> ...	39
<i>pleurotheca</i> , BRANCHIURA ...	256	<i>urivillii</i> ...	38
PLEUROTOMA <i>casearia</i> ...	214, 220	PSEUDAVICULA ...	319
PLEUROTOMELLA <i>fastosa</i> ...	288, 295	<i>anomala</i> ...	319
<i>repratca</i> ...	288	<i>papyracea</i> ...	319
<i>plexa</i> , COLUMBELLA ...	285	PSEUDOCHEBOMIS <i>muelleri</i> ...	62
<i>plumigera</i> , LAGENA ...	307	PSEUDOLABRUS <i>guentheri</i> ...	70
POLINICES <i>beddomei</i> ...	288	<i>punctulatus</i> ...	69
<i>subcostatus</i> ...	214, 288	<i>tetricus</i> ...	70
<i>umblicata</i> ...	288	PSEUDOMONACANTHUS <i>brownii</i> ...	80
POLYACANTHUS <i>opercularis</i> , ...		<i>galii</i> ...	79
breeding habits of ...	1	<i>granulatus</i> ...	80, 210
POLYMELA <i>chevreuxi</i> ...	162	<i>hippocrepis</i> ...	80
<i>hispidus</i> ...	162	PSEUDORHOMBUS <i>muelleri</i> ...	73
<i>panopæ</i> ...	162	PSEUDORISSOINA <i>elegans</i> ...	51
<i>panopæ</i> var. <i>squamifera</i> ...	162	<i>exigua</i> ...	42
POLYMORPHINA <i>alveolinifera</i> ...		PSILOCHORUS <i>sphaeroides</i> ...	23
<i>mis</i> ...	305, 308	PSOROPTES <i>equi</i> ...	191
<i>polyommata</i> , PTERYGOTRIGLA ...	74	<i>communis</i> , var. <i>equi</i> ...	191
<i>polyommata</i> , TRIGLA ...	74	<i>longirostris</i> , var. <i>equi</i> ...	191
POLYSTOMELLA <i>crispa</i> ...	310	PTEROCOLUS <i>caudacutus</i> ...	186
<i>macella</i> ...	306, 310	<i>manicatus</i> ...	186
<i>subnudosa</i> ...	310	PTERODECTES <i>paradisineus</i> ...	186
POLYTREMA <i>minivaceum</i> ...	310	PTEROLICHUS <i>affinis</i> ...	183, 184
POMADASIS <i>hasta</i> ...	63	<i>aquilinus</i> , var. <i>mitraluna</i> ...	184
POROCIDARIS <i>elegans</i> ...	271, 345	<i>brachiatus</i> , var. <i>crassior</i> ...	183
POROLEDA <i>ensiculus</i> ...	214, 288	<i>chiragicus</i> ...	183
POROMYA <i>laris</i> ...	288, 302	<i>cultri ventris</i> ...	185
<i>undosa</i> ...	214, 224	<i>falculiger</i> ...	184
<i>porosa</i> , OREULINA ...	306	<i>favettei</i> ...	184
<i>porosus</i> , UPENEUS ...	64	<i>lunula</i> ...	183
PORTHEUS <i>australis</i> ...	7	<i>ornatus</i> ...	183
<i>postoculatum</i> , AMBLYOMMA ...	170	<i>phylloproctus</i> var. <i>minor</i> ...	183
<i>praecincta</i> , TRUNCATULINA ...	309	<i>spatuliger</i> ...	184
<i>pretiosa</i> , BRYOBIA ...	152	<i>velifer</i> ...	184
<i>pransa</i> , ATYS ...	285	PTERYGOTRIGLA <i>polyommata</i> ...	74
<i>profundior</i> , RISSOA ...	358	PTILOTTIS <i>versicolor</i> ...	29
PRONUCULA <i>decorosa</i> ...	288	<i>versicolor</i> , eggs of ...	30
<i>minuta</i> ...	288	<i>versicolor</i> , nest of ...	29

	PAGE		PAGE
<i>pulchellum</i> , CARDIUM	213, 285	<i>recurvirostris</i> , HISTIOPTERUS	62
<i>pulcher</i> , COPIDOGNATHUS	... 163	<i>recurvirostris</i> , PENTACEROPSIS	62
<i>pulcher</i> , HALACARUS	... 163	<i>reflexus</i> , ARGAS	... 163
<i>Pulex fasciatus</i>	... 103	<i>reticulata</i> , ARCA	... 41, 285
PULLENIA <i>obliquiloculata</i>	... 309	<i>reticulata</i> , TRUNCATULINA	... 309
<i>quinquelobata</i>	... 309	RHAPHIDOZOOM <i>brandtii</i>	... 280
<i>pullus</i> , ODAX	... 71	<i>panhora</i>	... 280
PULTEA <i>discoidalis</i>	... 180	RHIPICEPHALÆ	... 165
PULVINULINA <i>menardii</i>	... 309	RHIPICEPHALUS <i>annulatus</i>	... 166
<i>micheliniana</i>	... 309	<i>annulatus</i> , var. <i>australis</i>	167
<i>punctatofasciatus</i> , GYMNO-		<i>calcaratus</i>	... 166
THORAX	... 58	<i>ellipticus</i>	... 165
<i>punctulata</i> , LABRICHTHYS	... 69	RHIPIDOSTOMA <i>leachi</i>	... 165
<i>punctulatus</i> , PSEUDOLABRUS	69	RHIPISTOMA <i>ellipticum</i>	... 165
PUNCTURELLA <i>demissa</i>	288, 289	<i>leachi</i>	... 165
<i>puniceus</i> , DIPLOCREPIS	... 205	<i>rhomboidea</i> , VERTICORDIA	... 215
<i>puniceus</i> , LEPIDOGASTER	... 205	<i>rhomboidea</i> , VERTICORDIA	... 303
PURPURA <i>sertata</i>	... 42, 219	RHOMBOSOLEA <i>basensis</i>	... 198
<i>purpurissatus</i> , AULOPUS	... 59	<i>flesoides</i>	... 197
<i>pygmaea</i> , BOLIVINA	... 307	<i>victoriae</i>	... 197
<i>pygmaea</i> , UVIGERINA	... 309	RHYNCHOLOPHIDÆ	... 154
<i>pyramidata</i> , CLIO	... 213, 285	RHYNCHOLOPHUS <i>celeripes</i>	... 155
<i>pyramidatus</i> , AMPHITHALMUS	285	<i>montanus</i>	... 155
PYRAMIDELLA <i>nitidula</i>	... 216	RHYNCHOPRION <i>columbæ</i>	... 163
PYRENE <i>babylonica</i>	... 358	<i>ribis</i> , BRYOBIA	... 152
<i>pyri</i> , ERIOPHES	... 192	<i>richardsonii</i> , ODAX	... 71
<i>pyri</i> , PHYTOPHUS	... 192	<i>richei</i> , SPHEROIDES	... 210
<i>pyrum</i> , CASSIDEA	... 213	<i>richei</i> , TETRAODON	... 210
		<i>ringens</i> , BILOCULINA	... 306
		RISSEA <i>bicolor</i>	... 288
		<i>filocincta</i>	214, 217, 288
		<i>integella</i>	... 288
		<i>novariensis</i>	... 288
		<i>olivacea</i>	... 42, 288
		<i>profundior</i>	... 358
		RISSEINA <i>elegantula</i>	... 288
		<i>rockwoodensis</i> , OXYTOMA	... 321
		<i>robustus</i> , SPRATELLOIDES	... 195
		<i>robustus</i> , STOLEPHORUS	... 195
		ROCHFORTIA <i>acuminata</i>	214, 288
		<i>angasi</i>	... 288
		<i>lactea</i>	... 214, 288
		<i>rosarum</i> , TETRANYCHUS	... 154
		<i>rosea</i> , ACTEON	... 285
		<i>rosea</i> , ATLANTA	... 285
		<i>rosea</i> , HEMAPHYSALIS	... 165
		<i>rotiformis</i> , DELTOCYATHUS	272
		ROTALIA <i>calcar</i>	... 310
		sp.	... 310
		<i>rothschildi</i> , CERATOPHYLLUS	103
		<i>rubra</i> , SCLENA	... 60
		<i>rubriventris</i> , TETRAGNATHA	332
		<i>rubrum</i> , HOLOCENTRUM	... 60
		<i>rufipes</i> , THERIDIUM	... 27
		<i>rufus</i> , CHEILOBRANCHUS	... 195
		<i>rufus</i> , CHILOBRANCHUS	... 195

## Q

<i>quadrata</i> , LYONIELLA	288, 302
<i>quadridentata</i> , CAVOLINIA	213, 285
<i>quadrigeminum</i> , SPHEROZOOM	280
<i>queenslandicus</i> , TYROGLYPHUS	180
<i>quindecim-punctata</i> , LINYPHIA	331
<i>quinquelobata</i> , PULLENIA	... 309

## R

<i>radialis</i> , BASILISSA	... 285
<i>radiata</i> , BORNIA	... 48
<i>radula</i> , TEREBRATULINA	43, 288
<i>rainbowi</i> , NEPHILIGENYS	... 336
<i>ramsayi</i> , LEDA	... 214
<i>RAPANA lischkeana</i>	213, 219
<i>rapax</i> , BERLESIA	... 173
<i>rattus</i> , MUS	... 312
<i>recta</i> , NOTOPHYLLIA	... 272

	PAGE		PAGE
<i>sageneus</i> , SYNODUS ...	58	SCHISMOPE <i>atkinsoni</i> ...	42, 288
<i>sagittula</i> , TEXTULARIA ...	307	SCLENA <i>antarctica</i> ...	63
SALMO <i>myops</i> ...	58	<i>armata</i> ...	71
<i>tumbil</i> ...	58	<i>rubra</i> ..	60
<i>sarcinula</i> , BATHYTOMA ..	53	SCISSURELLA <i>australis</i> ...	288
SARCOPTES <i>anacanthos</i> ...	190	<i>scitula</i> , TURRITELLA... ..	42
<i>canis</i> ... ..	189	SCLEROPTERYX ... ..	209
<i>cati</i> ... ..	188	<i>derisi</i> ... ..	209
<i>communis</i> ... ..	189	<i>scobina</i> , CANCELLARIA	
<i>equi</i> ... ..	189, 191	213, 222, 285, 360	
<i>hominis</i> ... ..	189	Scolecite, Werris Creek, N. S.	
<i>minor</i> ... ..	188	Wales ... ..	421
<i>mutans</i> ... ..	190	SCOLOPSIS <i>bimaculatus</i> ...	63
<i>notoedres</i> , var. <i>cati</i> ...	188	SCOMBER <i>speciosus</i> ... ..	71
<i>scabiei</i> ... ..	189	SCORPÆNA <i>horrida</i> ... ..	74
<i>scabiei</i> , var. <i>equi</i> ...	189	<i>panda</i> ... ..	74
<i>scabiei</i> , var. <i>hominis</i> ...	189	<i>percoides</i> ... ..	350
<i>scabiei</i> , var. <i>wombati</i>	190	<i>paigensis</i> ... ..	61
<i>squamiferus</i> ... ..	189	SCORPIS <i>georgianus</i> ... ..	64
<i>wombati</i> ... ..	190	SCUPTIOR, CLATHURELLA ...	298
SARCOPTIDE ... ..	187	<i>sculptior</i> , DAPHNELLA ...	286, 298
SARCOPTOIDEA ... ..	149	<i>scutatus</i> , CENTRISCUS ...	59
SAREPTA <i>oholella</i> ... ..	288	SCYLLARUS <i>sieboldi</i> ... ..	231
SAURIDA <i>tumbil</i> ... ..	58	SCYLLIORHINUS <i>analis</i> ...	228
SAURUS, ELOPS ... ..	58	SCYLLIUM <i>anale</i> ... ..	228
<i>scabiei</i> , ACARUS ... ..	189	SEBASTES <i>percoides</i> ... ..	350
<i>scabiei</i> , SARCOPTES ... ..	189	<i>securiforme</i> , CRASSATELLITES	
<i>scabiei</i> , var. <i>equi</i> , SARCOPTES	189	42, 286, 301	
<i>scabiei</i> , var. <i>hominis</i> , SARCOPTES	189	<i>securiger</i> , ALLOPTES... ..	185
TES ... ..	189	SEIUS <i>acanthurus</i> ... ..	173
<i>scabiei</i> , var. <i>wombati</i> , SARCOPTES	190	SEMIRADIATA, MONTACUTA ...	301
COPTES ... ..	190	<i>semiradiatus</i> , CORIARIUS ...	286
<i>scabra</i> , BULLINA ... ..	213	<i>semisulcatus</i> , PENEUS ...	119
SCRABRINUSCULUS, EUCHELUS ...	286	SEPARANS, MILIOLINA ... ..	306
SCALA ... ..	360	<i>serratus</i> , PLECTROPOMA ...	61
<i>distincta</i> ... ..	288	<i>serricatum</i> , TROMBIDIUM ...	158
<i>yukesiana</i> ... ..	288	<i>sertata</i> , PURPURA ... ..	42, 219
<i>terjuliata</i> ... ..	288, 290	<i>setosa</i> , VERTICORDIA ... ..	303
<i>minutula</i> ... ..	42, 52	<i>sextuberculata</i> , ULESANIS ...	27
<i>morchi</i> ... ..	214	<i>sieboldi</i> , SCYLLARUS... ..	231
<i>translucida</i> ... ..	288, 290	SILIQVARIA <i>weldii</i> ... ..	42
<i>turrispharai</i> ... ..	52	<i>simplex</i> , ODOSTOMIA ... ..	287
SCALARIA ... ..	360	<i>simplex</i> , TROPHON ... ..	214, 288
<i>minutula</i> ... ..	52	<i>simsoni</i> , MARGINELLA ... ..	287
<i>scalariformis</i> , MITRA ... ..	287	<i>simsoni</i> , STEPHANOCIRCUS ...	108
<i>scalaris</i> var., LIOTIA <i>tasmanica</i> ..	287	SINGOTYPNA <i>melania</i> ... ..	335
<i>scalaris</i> , NODOSARIA ... ..	308	<i>melanopygia</i> ... ..	335
SCATOPHAGUS <i>multifasciatus</i> ...	66	<i>sinuata</i> , TURRITELLA ... ..	214
<i>sceleratus</i> , SPHEROIDES ... ..	82	SIRIUS <i>badius</i> ... ..	42, 288
<i>sceleratus</i> , TETRAODON ... ..	82	SIRO, ACARUS... ..	180, 189
<i>scelio</i> , LATRODECTUS ... ..	28	SIRO, TYROGLYPHUS ... ..	180
Scheelite, Hillgrove, N. S.		SMARIDIA <i>extranea</i> ... ..	155
Wales ... ..	414	<i>smithiana</i> , TURRITELLA ... ..	288
Scheelite, Mount Ramsay, Tasmania ..	415	<i>socialis</i> , AMAUROBIUS ... ..	9
		<i>sophia</i> , TURRITELLA ... ..	289

	PAGE		PAGE
<i>sorbi</i> , PHYTOPHUS ...	192	<i>strangei</i> , MARGINELLA ...	214, 287
<i>spathuliger</i> , PSEUDALLOPTES ...	184	<i>strangei</i> , MITRA ...	42, 287
<i>spatuliger</i> , PTEROLICHUS ...	184	<i>strangulata</i> var., CAVOLINIA	
<i>spatula</i> , CREPIDOGASTER ...	201	<i>longirostris</i> ...	285, 299
<i>speciosa</i> , BRYOBIA ...	152	<i>striata</i> , LAGENA ...	308
<i>speciosa</i> , PETROBIA ...	152	<i>stricta</i> , ADMETE ...	285, 295
<i>speciosus</i> , ACHORUTES ...	314	<i>strictus</i> , var. <i>australis</i> , SYM-	
<i>speciosus</i> , CARANX ...	71	PHIPIUS ...	349
<i>speciosus</i> , SCOMBER ...	71	<i>strigatus</i> , ÆOLISCTUS ...	59
<i>SPILEROIDES hamiltoni</i> ...	210	<i>stuarti</i> , VANIKOROPSIS ...	327
<i>richei</i> ...	210	<i>sturti</i> , DELPHINULA ...	327
<i>sceleratus</i> ...	82	<i>stylasteris</i> , PEDICULARIA ...	42
<i>SPHÆROZOUUM alveolatum</i> ...	281	<i>subcostatus</i> , POLINICES ...	214, 288
<i>geminatum</i> ...	281	<i>sublutea</i> , LINYPHIA ...	331
<i>quadrigeminum</i> ...	280	<i>subnudosa</i> , POLYSTOMELLA ...	310
<i>sphaeroides</i> , PSILOCHOROUS ...	23	<i>subocellatus</i> , PATÆCUS ...	76, 77
<i>SPHYRENA obtusata</i> ...	60	<i>subrotundata</i> , GAUDRYINA ...	307
<i>spica</i> , MANGELIA ...	287, 297	<i>subsquamosa</i> , TURRITELLA ...	289
<i>spinulipes</i> , UROPODA ...	175	<i>subula</i> , CLIO ...	213, 285
<i>SPIRILLINA limbata</i> ...	309	<i>sulcata</i> , LAGENA ...	305, 307
<i>limbata</i> , var. <i>denticulata</i> ...	309	<i>sulcata</i> , var. <i>annularis</i> , LA-	
<i>SPIROLOCULINA arenaria</i> ...	306	GENA ...	307, 311
<i>excavata</i> ...	306	<i>superba</i> , EMARGINATA ...	214, 216, 286
<i>fragilissima</i> ...	306	<i>super-concha</i> , CORBULA ...	324
<i>impressa</i> ...	306	<i>sussmilchi</i> , GANORHYNCHUS ...	129
<i>limbata</i> ...	306	<i>symbiotes</i> , var. <i>ovis</i> , CHORIOP-	
<i>tenniseptata</i> ...	306	TES ...	191
sp. ...	306	<i>SYMPHTRUS strictus</i> , var. <i>aus-</i>	
<i>SPIRULÆA</i> ...	318	<i>talis</i> ...	349
<i>gregaria</i> ...	318	<i>SYNANCIDIUM horridum</i> ...	74
<i>splendens</i> , PHYLARCHUS ...	26	<i>SYNODUS sagenens</i> ...	58
<i>splendida</i> , MODIOLARIA ...	287	<i>syri-gianus</i> , TYPHIS ...	289
<i>SPRATTELLOIDES robustus</i> ...	195	<i>SYRNOLA nitidula</i> ...	216
<i>spretus</i> , CADULUS ...	213, 285		
<i>squamea</i> , ADACNARCA ...	45, 213, 285		
<i>squamifera</i> var., HALACA-			
RUS <i>panopæ</i> ...	162		
<i>squamifera</i> var., POLYMELA			
<i>panopæ</i> ...	162		
<i>squamiferus</i> , SARCOPTES ...	189		
<i>squamipinnis</i> , PARMA ...	68, 69		
<i>squamosa-marginata</i> , LAGENA ...	307		
<i>stanislaus</i> , MARGINELLA ...	287		
<i>STEPHANOCIRCUS dasyuri</i> ...	107		
<i>mars</i> ...	108		
<i>minerva</i> ...	108		
<i>simsoni</i> ...	108		
<i>thomasi</i> ...	108		
<i>stephensii</i> , HOPLOCEPHALUS,			
Climbing habits of ...	38		
<i>Stilbite</i> , Jamberoo, N.S. Wales ...	422		
<i>stilla</i> , MARGINELLA ...	42, 214, 287		
<i>stilosus</i> , LÆLAPS ...	173		
<i>stimuleus</i> , TROPHON ...	288, 293		
<i>STIVA ferruginea</i> ...	288		
<i>STOLEPHORUS robustus</i> ...	195		

## T

<i>tabida</i> , EUTHRIA ...	214, 286
<i>tarandus</i> , EUFREYANA ...	182
<i>tarandus</i> , FREYANA ...	182
TARSONEMIDÆ ...	176
TARSONEMUS <i>anaeus</i> ...	178
<i>anaeus</i> ...	178
<i>baneroffi</i> ...	177
<i>tasmanianus</i> , BLENNIUS ...	205
<i>tasmanica</i> , var., ACMEIA	
<i>parva</i> ...	210
<i>tasmanica</i> , COCCULINA ...	213, 215
<i>tasmanica</i> , DAPHNELLA ...	286
<i>tasmanica</i> , HYDATINA ...	286
<i>tasmanica</i> , LIOTIA ...	42
<i>tasmanica</i> , MITRA ...	287
<i>tasmanica</i> , NACELLA ...	215
<i>tasmanica</i> , var. <i>scalaris</i> , LIO-	
TIA ...	...

	PAGE		PAGE
<i>tasmanica</i> , VULPECULA ...	215	Theridion ...	27
<i>tasmani</i> , IXODES ...	167	<i>albi-striatum</i> ...	27
<i>tatei</i> , PHILOBRYA ...	288	<i>rufipes</i> ...	27
<i>tatei</i> , XENOPHORA ...	215, 289	<i>tepidariorum</i> ...	27
<i>telarius</i> , ACARUS ...	153	<i>thetidis</i> , AMUSIUM 41, 213, 223, 285	285
<i>telarius</i> , var. <i>cinnabarinus</i> , TETRANYCHUS ...	153	<i>th. tidis</i> , CYLICHNA ...	213
<i>telarius</i> , TETRANYCHUS ...	153	<i>thomasi</i> , STEPHANOCIRCUS ...	108
TELLINA <i>tenuilirata</i> ...	289	Thomsonite, Inverell, N. S. Wales ...	420
<i>tenisoni</i> , LIMOPSIS ... 42, 214,	287	THORECTA <i>meandrina</i> ...	120
<i>tenuilirata</i> , TELLINA ...	288	THRACIOPSIS <i>arenosa</i> ...	42, 288
<i>tenuirostre</i> , EDOLIISOMA ...	340	THREPETERIUS <i>maculosus</i> ...	63
<i>tenuis</i> , CONOPORA ...	41	THYASIRA <i>albigena</i> ...	363
<i>tenuis</i> , CYLICHNA ...	54	TIBERIA <i>nitidula</i> ...	214, 216
<i>tenuiseptata</i> , SPIROLOCULINA	306	<i>tomsoni</i> , MUS ...	312
<i>tephræops</i> , CREPIDENS ...	63	Topaz, Emmaville, N.S. Wales	83
TEPHRÆOPS <i>tephræops</i> ...	63	Topaz, Oban, N.S. Wales ...	85
<i>tephræops</i> , TEPHREOPS ...	63	Topaz, Bell Mount, Middle- sex, Tasmania ...	88
<i>tepidariorum</i> , THERIDION ...	27	Topaz, Flinder's Island, Tas- mania ...	87
TERAPON <i>humeralis</i> ...	62	Topaz, Mt. Cameron, Tasmania	85
TEREBRA <i>lauretanae</i> ...	214, 222	<i>torcularis</i> , LIPPITES ...	287
TEREBRATULINA <i>radula</i> ...	43, 288	TOTANUS <i>incanus</i> ...	343
<i>teres</i> , PHILINE ...	288	TRACHICHTHYS <i>intermedius</i> ...	349
<i>terreginensis</i> , CANCELLARIA	327	TRACHINOCEPHALUS <i>myops</i> ...	58
<i>tetracentrus</i> , ANALGES ...	185	TRACHINOTUS <i>bailtonii</i> ...	71
TETRAGNATHA <i>concinna</i> ...	332	<i>trapezia</i> , PHILINE ...	361
<i>cylindrica</i> ...	332, 333	<i>trapezina</i> , PHILINE ...	288
<i>demissa</i> ...	332	<i>translucida</i> , SCALA ...	288, 290
<i>ferox</i> ...	332	TREMATOTROCHUS sp. ...	272
<i>gemmata</i> ...	332	<i>verconis</i> ...	272
<i>lupata</i> ...	332	<i>tricarinata</i> , DRILLIA ...	213, 286
<i>hituberculata</i> ...	332	<i>tridentata</i> , CAVOLINIA ...	213, 285
<i>margaritata</i> ...	332	TRIGLA <i>kumu</i> ...	75
<i>protensa</i> ...	332	<i>polyommata</i> ...	74
<i>rubriventris</i> ...	332	<i>trigona</i> , ALLOMORPHINA ...	307
<i>valida</i> ...	332	<i>trigonalis</i> , MACTRA ...	326
TETRAGNATHINÆ ...	332	TRIGONIA <i>cinclata</i> ...	322
TETRANYCHIDÆ ...	151	<i>margaritacea</i> ...	288
TETRANYCHUS <i>cucumeris</i> ...	154	<i>trigonula</i> , ALLOMORPHINA ...	306
<i>rosarum</i> ...	154	<i>trigonula</i> , MILIOLINA ...	306
<i>telarius</i> ...	153	<i>triguttatum</i> , AMBLYOMMA ...	170
<i>telarius</i> , var. <i>cinnabari-</i> <i>rinus</i> ...	153	<i>trilobar</i> , var., GLOBIGERINA <i>bulloides</i> ...	309
TETRAODON <i>hispidus</i> ...	210	<i>trimaculatum</i> , APOKOMMA ...	168
<i>richei</i> ...	210	<i>trimaculatus</i> , IXODES ...	168
<i>sceleratus</i> ...	82	<i>trispinosa</i> , CAVOLINIA ...	213, 285
<i>letricus</i> , LABRUS ...	70	TRIVIA <i>avellanoides</i> ...	288, 293
<i>letricus</i> , PSEUDOLABRUS ...	70	<i>trochus</i> , TEXTULARIA ...	307
TEXTULARIA <i>agglutinans</i> ...	307	<i>trolodytica</i> , ISOGOMA ...	313
<i>sagittula</i> ...	307	<i>troglydutes</i> , ECTATOSTICA ...	338
<i>trochus</i> ...	307	<i>troglydutes</i> , THERIDION ...	338
<i>textularoides</i> , BOLIVINA ...	307	TROMBIDIIDÆ ...	156
THALASSOGERON <i>cautus</i> ...	344	TROMBIDIUM <i>papuanum</i> ...	158
THECIDEA <i>maxilla</i> ...	45	<i>serricatum</i> ...	158
THERIDION <i>troglydutes</i> ...	338		
THERAPON <i>humeralis</i> ...	62		

	PAGE		PAGE
TROMBOIDEA ...	149, 150	<i>universa</i> , ORBULINA ...	309
TROPHON <i>carduelis</i> ...	214	UPENEUS <i>porosus</i> ...	64
<i>goldsteini</i> ...	288	UROPODA <i>spinulipes</i> ...	175
<i>laminatus</i> ...	214, 288	UROPODIDÆ ...	175
<i>simplex</i> ...	214, 288	<i>urvillii</i> , PSEUDAPHRITIS ...	38
<i>stimuleus</i> ...	288, 293	UTRICULARIA killing fish-fry	3
TROUSSARTIA <i>caudacuta</i> ...	186	<i>ura</i> , LIOTHYRIS ...	43
<i>truncata</i> , CUSPIDARIA ...	47	UVIGERINA <i>canariensis</i> ...	309
TRUNCATULINA <i>echinata</i> ...	309	<i>pygmaea</i> ...	309
<i>lobatula</i> ...	309	sp. ...	309
<i>præcineta</i> ...	309		
<i>reticulata</i> ...	309	V	
sp. ...	309	<i>vadosa</i> , VERTICORDIA	289, 303
<i>wnellenstorffii</i> ...	309	<i>vagens</i> , HYPERAMMINA ...	307
<i>truncatus</i> , CHELTONDON ...	67	<i>vagensis</i> , CENTROGENYS ...	61
<i>truncatus</i> , CHELMONOPS ...	67	<i>vagensis</i> , SCORPENA ...	61
TUBIFEX <i>dauidis</i> ...	252	<i>valida</i> , TETRAGNATHA ...	332
<i>tumbil</i> , SALMO ...	58	<i>validus</i> , LAMBRUS ...	231
<i>tumbil</i> , SAURIDA ...	58	VANIKOROPSIS <i>stuarti</i> ...	327
TURBONILLA <i>constricta</i> ...	214	<i>carani</i> , XNODIS ...	168
<i>varicifer</i> ...	42	<i>variabilis</i> , MUS ...	312
TURNIX <i>velox</i> ...	342	<i>varicifer</i> , TURBONILLA ...	42
TURQUETIA <i>integra</i> ...	364	<i>velifer</i> , PROTOLICHUS ...	184
<i>turrisphari</i> , SCALA ...	52	<i>velifer</i> , PTEROLICHUS ...	184
<i>turrita</i> , EULIMELLA ...	42	<i>velox</i> , TURNIX ...	342
TURRITELLA <i>curialis</i> ...	357	VENERICARDIA <i>cavatica</i> ...	215, 289
<i>godeffroyana</i> ...	214	<i>dilecta</i> ...	289
<i>incisa</i> ...	214	<i>ventricosa</i> , NEPHILA ...	336
<i>opulenta</i> ...	288, 292	<i>vepratica</i> , PLEUROTOMELLA ...	288
<i>philippensis</i> ...	214	<i>verconis</i> , TREMATOTROCHUS ...	272
<i>scitula</i> ...	42	VERMETUS <i>waiti</i> ...	42
<i>sinuata</i> ...	214	VERMICLIARIA <i>vadosa</i> ...	289, 292
<i>smithiana</i> ...	288	<i>waiti</i> ...	289
<i>sophiæ</i> ...	289	<i>versicolor</i> , PTILOTTIS ...	29
<i>subsquamosa</i> ...	289	<i>versicolor</i> , PTILOTTIS, eggs of ...	30
TYPHIS <i>syringianus</i> ...	289	<i>versicolor</i> , PTILOTTIS, nest of ...	29
<i>philippensis</i> ...	289	<i>vertebralis</i> , NODOSARIA ...	308
<i>typicus</i> , FASCINUS ...	286	VERTICORDIA <i>australiensis</i> ...	303
TYROGLYPHIDÆ ...	178	<i>rhomboidea</i> ...	215, 303
TYROGLYPHUS <i>entomophagus</i> ...	180	<i>setosa</i> ...	303
<i>queenslandicus</i> ...	180	<i>vadosa</i> ...	289, 303
<i>sivo</i> ...	180	<i>vesicularis</i> , DISCORBINA ...	309
		<i>vestalis</i> , DAPHNELLA ...	213, 286
		Vesuvianite, BARRABA, N. S.	
U		Wales ...	415
ULESANIS ...	27	<i>vi toriæ</i> , PLEURONECTES ...	197
<i>sextovergulata</i> ...	27	<i>victoria</i> , RHOMBOSOLEA ...	197
<i>umbilicata</i> , EURYOPSIS ...	26	<i>vincenti</i> , PATECUS ...	77
<i>umbilicata</i> , POLINICES ...	288	<i>virgula</i> , CLIO ...	213, 285
<i>undata</i> , ASPELLA ...	285, 294	<i>viridiauratus</i> , MACROPODUS ...	1
<i>undosa</i> , POROMYA ...	214, 224	<i>vitreus</i> , CORIAREUS ...	286, 301
<i>undulata</i> , VOLUTA ...	215, 289	<i>viriparus</i> , KNEMIDOKOPTES ...	190
<i>uniforis</i> , COLLOSPHÆRA ...	282		

	PAGE
<i>VOLUTA undulata</i>	215, 289
<i>VULPECUA miranda</i>	215
<i>tasmanica</i> ...	215
<i>vulpina</i> , HARPE ...	70
<i>vulpinus</i> , COSSYPHUS	70

## W

<i>waiteri</i> , VERMETUS ...	42
<i>waiteri</i> , VERMICULARIA	289
<i>watehousii</i> , PATECUS	76
<i>watsoni</i> , MANGELIA ...	214
<i>weldii</i> , CIRSONELLA	41, 285
<i>weldii</i> , SILIQUARIA	42
<i>weburdi</i> , BATHYPHANTES ...	331
<i>whani</i> , MARGINELLA	42, 287
<i>willemoesi</i> , MEGERLIA	43
<i>wollumbillaensis</i> , ASTARTE	327
<i>wombati</i> , SARCOPTES	190
<i>wombati</i> , var., SARCOPTES	190
<i>scabiei</i> ...	190
<i>woolsi</i> , DRILLIA	213
<i>woodwardi</i> , BRAMICHTHYS	72
Workshops, Aboriginal, N.S.	
Wales ...	233
Belambi Beach	236
Bondi ...	235
Cronulla Beach	235

	PAGE
Maroubra	234
Adzes ...	249
Anvils ...	236
Gouges ...	249
Gravers ...	243
Grindstones ...	236
Knives, chipped-back	238
Nose-style ...	249
Rasps ..	249
Scrapers ..	241, 249
Shell deposits ...	237
Spear-baib flakes ...	244
<i>wuelenstorffii</i> , TRUNCATULINA	309

## X

XENOPHORA <i>tatei</i> ...	215, 289
----------------------------	----------

## Z

<i>zelicira</i> , DELIOCHUS ...	335
<i>zelivira</i> , META ...	335
Zeolites ...	416
Zircon, Glen Innes, N.S. Wales	95
Zircon, Inverell, N.S. Wales	96
Zircon, Boat Harbour, Tas-	96
mania ...	96











EXPLANATION OF PLATE I.

---

ICHTHYODECTES MARATHONENSIS, *Eth. fil.*

Skull seen slightly obliquely from below.

- m.* Right maxilla.  
*de.* „ and left dentaries.  
*ar.* „ „ articulars.  
*eth. & f.?* Ethmoid or frontal (?)  
*hm.* Hyomandibular or preoperculum.  
*pr.*  
*hy.* Hyoid bones.  
*op.* Operculum.  
*r.* Ribs.  
*v.* Vertebræ.  
*f.* Displaced fin rays.

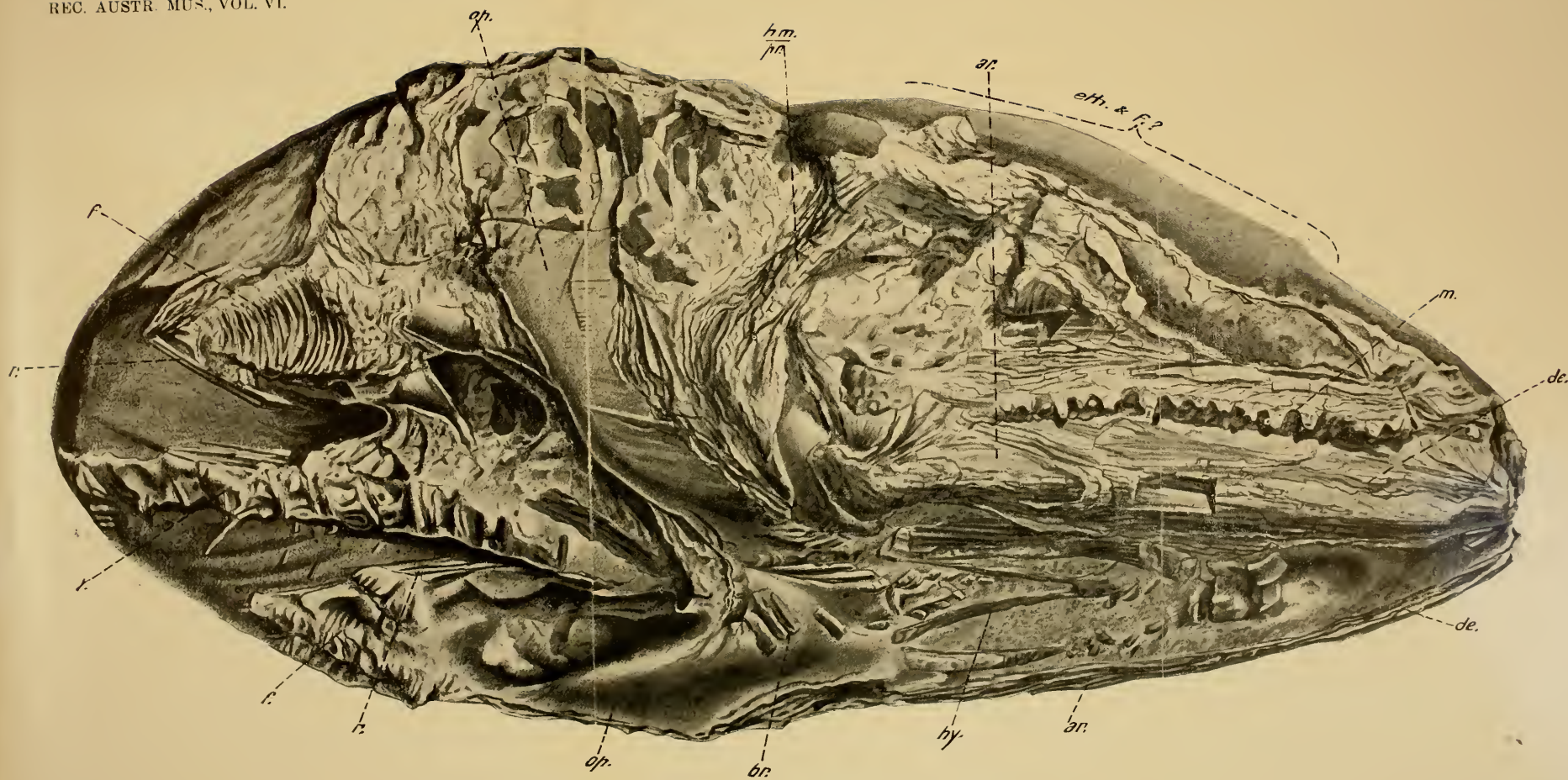

F. R. LEGGATT, del.





EXPLANATION OF PLATE II.

---

ICHTHYODECTES MARATHONENSIS, *Eth. fil.*  
Skull seen from below.  
[For lettering see Explanation of Plate i.]









EXPLANATION OF PLATE III.

---

Portion of web of *Amaurobius socialis*, Rainb.

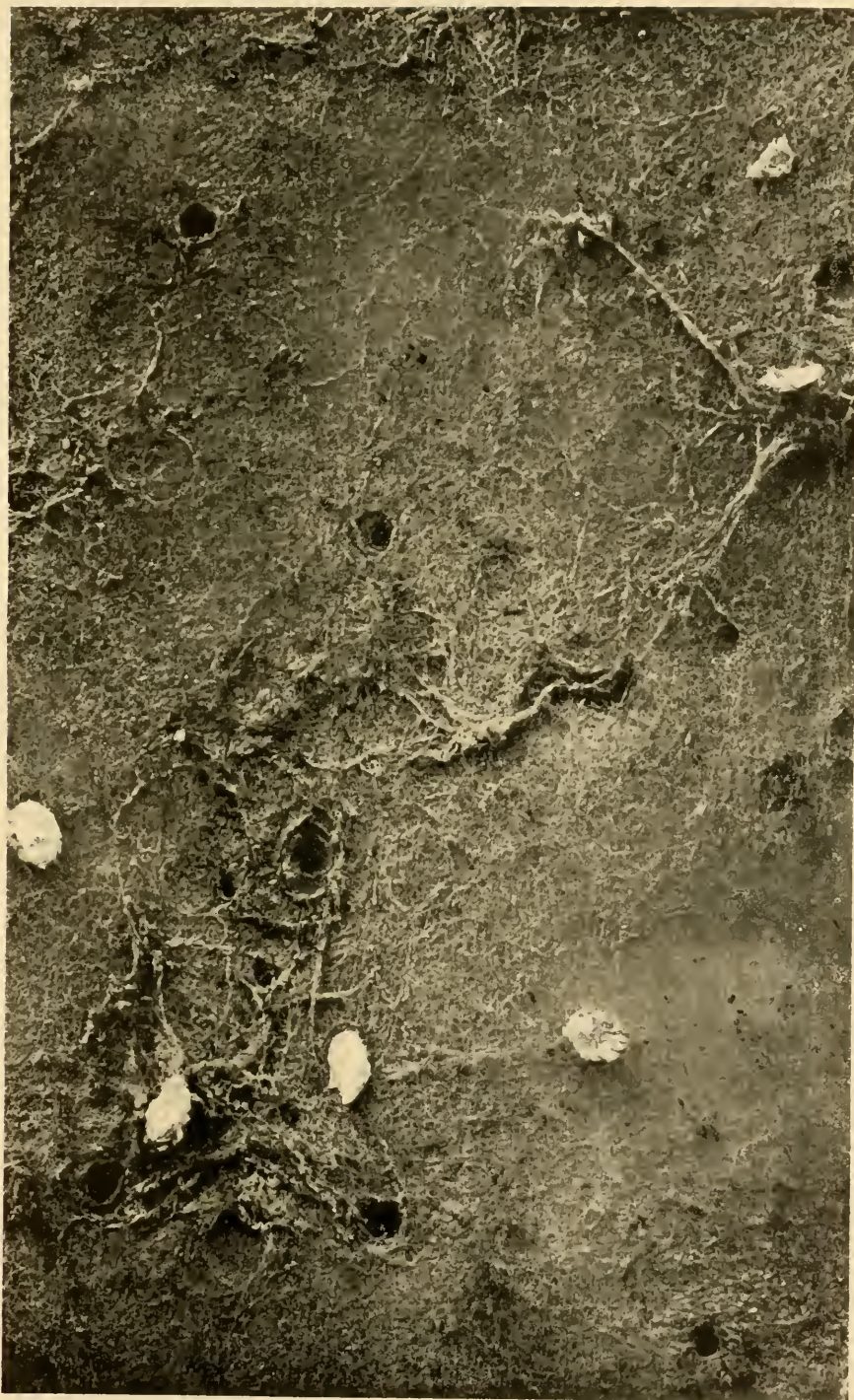

H BARNES, Junr., photo.,  
Austr. Mus.





EXPLANATION OF PLATE IV.

---

HALICORE DUGONG, *Gmelin*, sp.

- Fig. 1. Portion of a rib showing cuts and chipping of the surface.  
  , 2. Largest rib-portion with traces of numerous cuts contiguous  
      to the concave edge.  
  , 3. Third rib-portion similar to fig. 1.  
      (The figures are seven-tenths the natural size).





1.



2.



3.





EXPLANATION OF PLATE V.

---

- Fig. 1. Portion of a skin of *Melithreptus brevicestris*, Vigors and Horsfield.  
Short-billed Honey-eater.
- „ 2. Portion of a skin of *Melithreptus maguistrostris*, North.  
Large-billed Honey-eater.
- „ 3. Nest and eggs of *Ptilotis versicolor*, Gould.  
Varied Honey-eater.
- (Figs. 1 and 2. Natural size. Fig. 3. About two-thirds natural size).



1.

2.

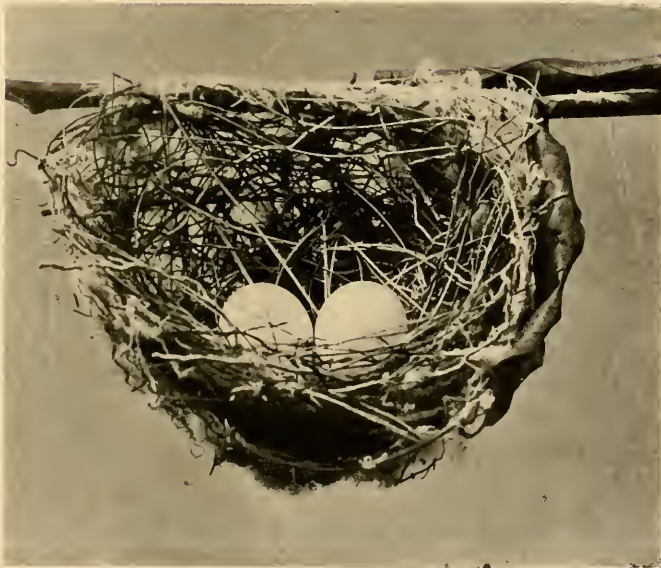

3.





EXPLANATION OF PLATE VI.

---

OPAL PSEUDOMORPHS, WHITE CLIFFS, N. S. WALES.

- Fig. 1. To the left of the central depression a crystal shows distinct cleavage traces on the edge.  
,, 2. Several crystals show pronounced cleavage traces.





1.



2.





## EXPLANATION OF PLATE VII.

GLAUBERITE CRYSTALS AND OPAL PSEUDOMORPHS, WHITE CLIFFS,  
N. S. WALES.

Forms :— $c$  (001),  $s$  (111),  $n$  ( $\bar{1}11$ ).

- Fig. 1. Projection on (001) of a glauberite crystal showing the forms  $s$  (111) and  $n$  ( $\bar{1}11$ ).
- .. 2. The same, with oscillation of (131) on  $s$  and of  $c$  on  $n$ .
- .. 3. Freehand drawing of a pseudomorphic opal crystal in similar position and showing the trace of the basal cleavage on  $n$  and striations supposed to be due to oscillatory combination of  $s$  with (131).
- .. 4. Projection of a glauberite crystal on a plane perpendicular to the zone axis  $ss'$ .
- .. 5. The same with traces of basal cleavage and (131) oscillating with  $s$ .
- .. 6. Freehand drawing of pseudomorphic opal crystal in similar position showing cleavage traces.
- .. 7. Projection of glauberite crystal on (010).
- .. 8. The same with oscillation of (131) on  $s$  and of  $c$  on  $n$ .
- .. 9. Freehand drawing of pseudomorphic opal crystal in similar position showing striations on  $s$  and cleavage traces on  $n$ .

Note.— $n'$  in the right hand half of fig. 4 should read  $n''$ , and in the left hand half  $n''$ .

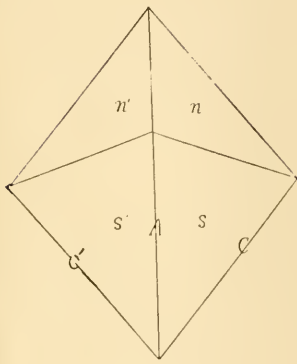

1

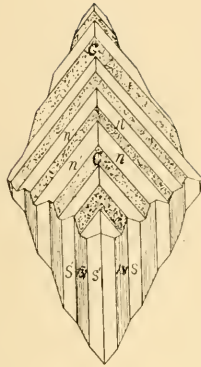

2



3

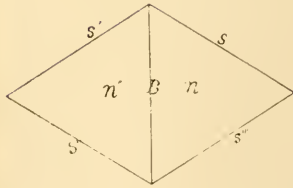

4

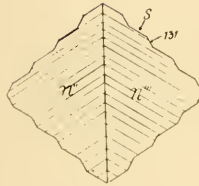

5



6

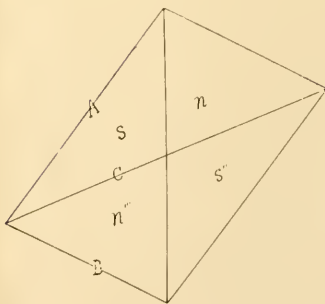

7

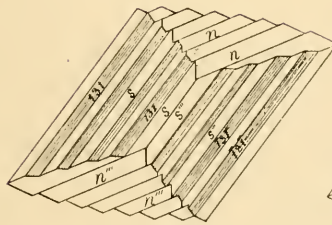

8

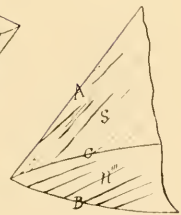

9





EXPLANATION OF PLATE VIII.

---

- Fig. 1. *Synodus sageneus*, Waite.  
,, 2. *Cynoglossus broadhursti*, Waite.  
(Both two-thirds natural size.)



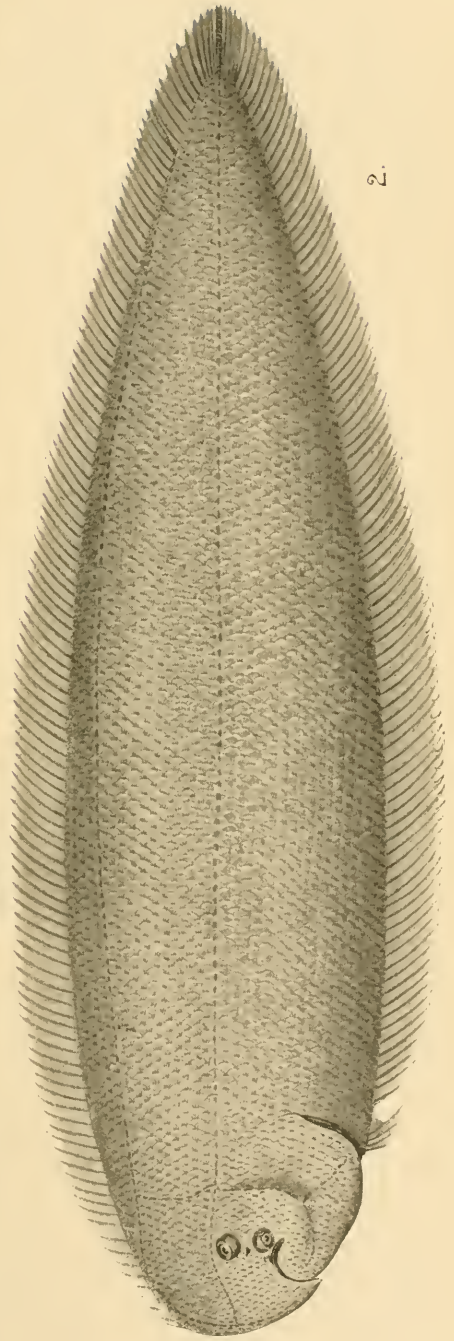
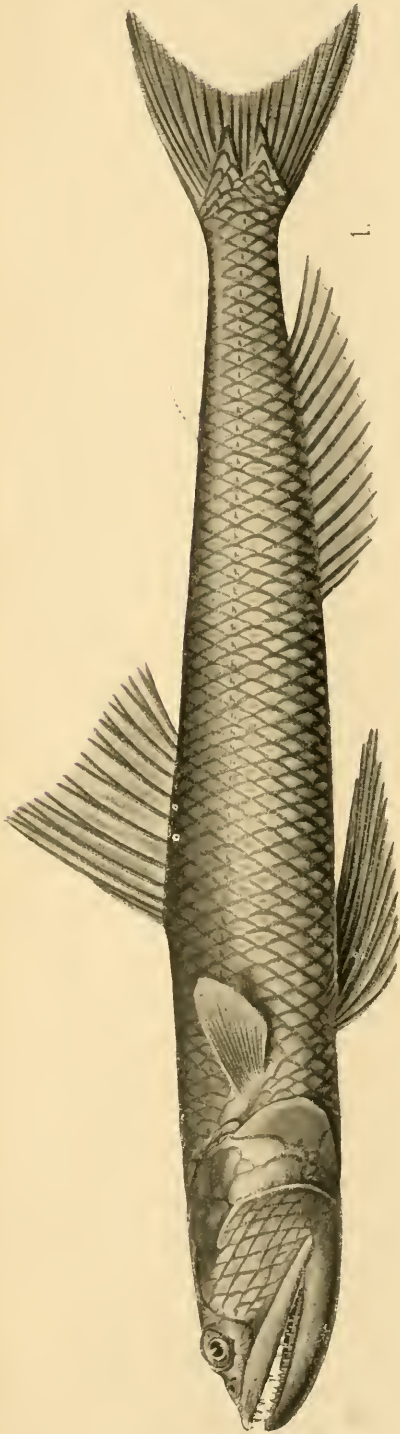

A. R. McCULLOCH, del.  
austr. Mus.





EXPLANATION OF PLATE IX.

---

*Terapon humeralis*, Ogilby.  
(Natural size.)

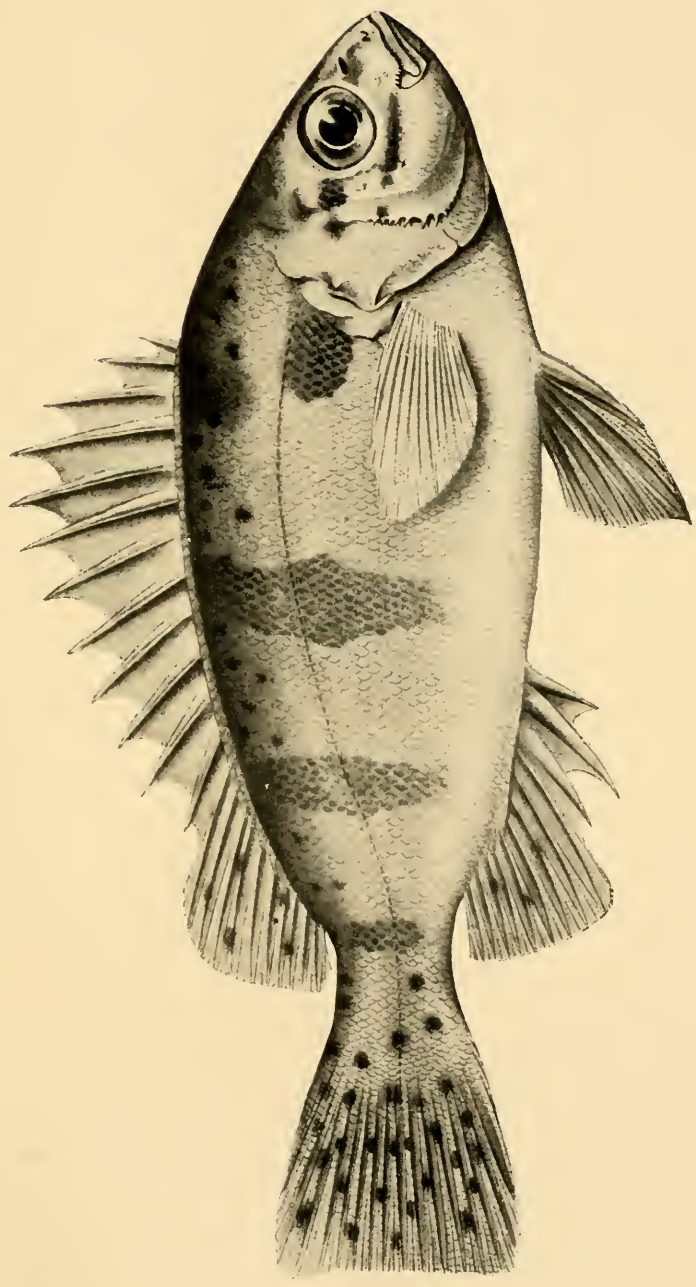

A. R. McCULLOCH. del.,  
Austr. Mus.





EXPLANATION OF PLATE X.

---

*Neatypus obliquus*, Waite.  
(Natural size.)



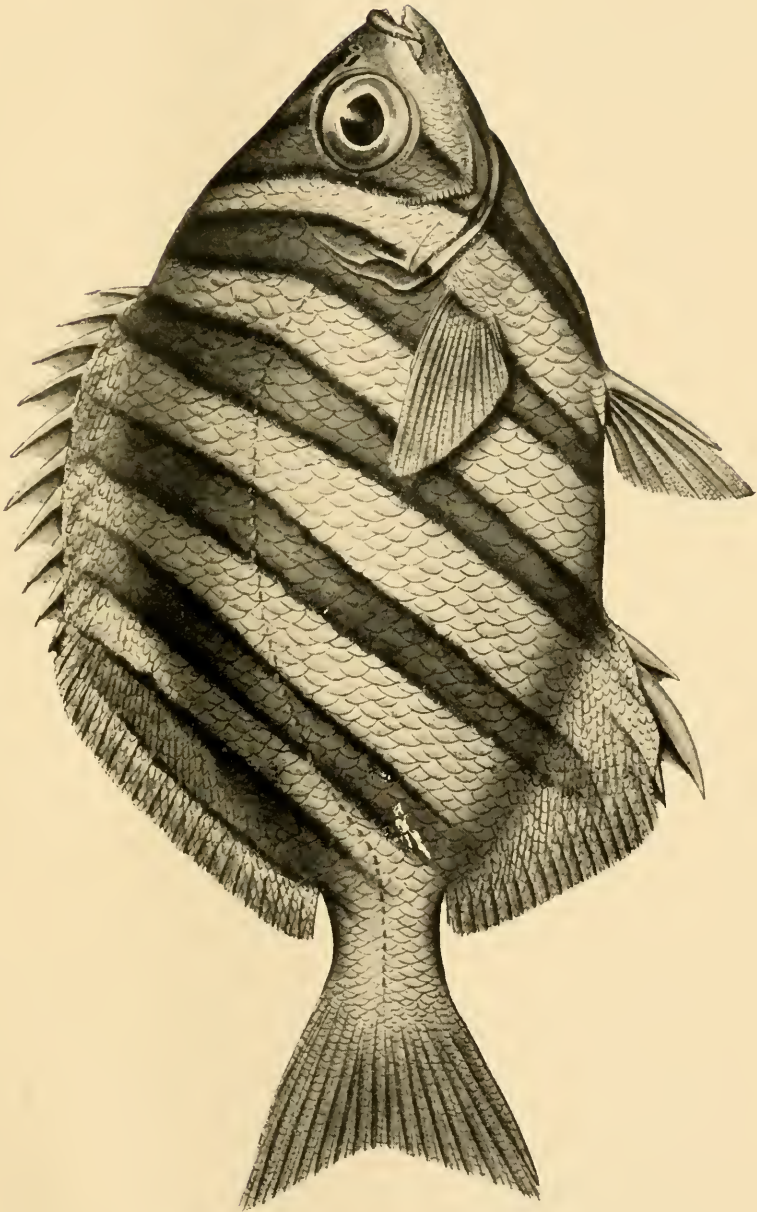





EXPLANATION OF PLATE XI.

---

Fig. 1. *Chaetodon assarius*, Waite.

„ 2. *Dipulus cæcus*, Waite.

(Both natural size.)

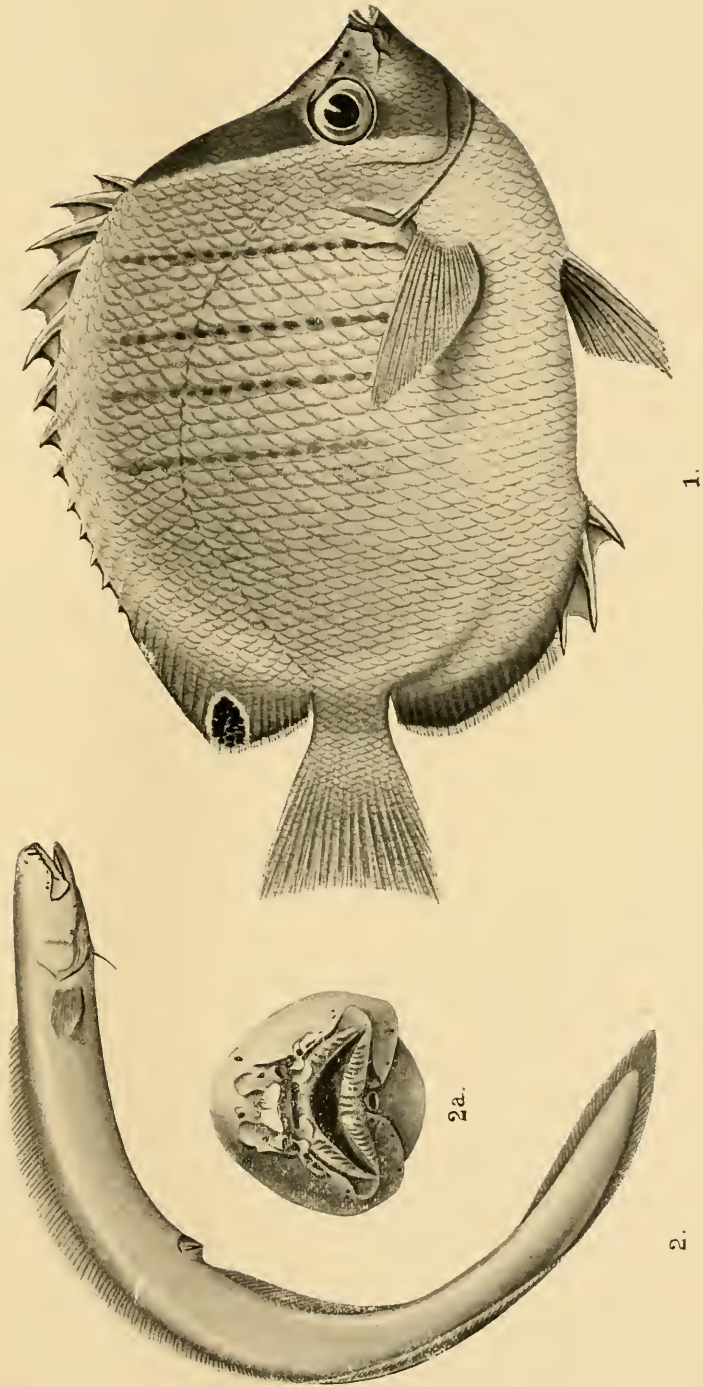





EXPLANATION OF PLATE XII.

---

*Hypsypops microlepis*, Günther.

- Fig. 1. Young, twice natural size.  
„ 2. „ enlarged one-seventh.  
„ 3. Adult, five-eighths natural size.



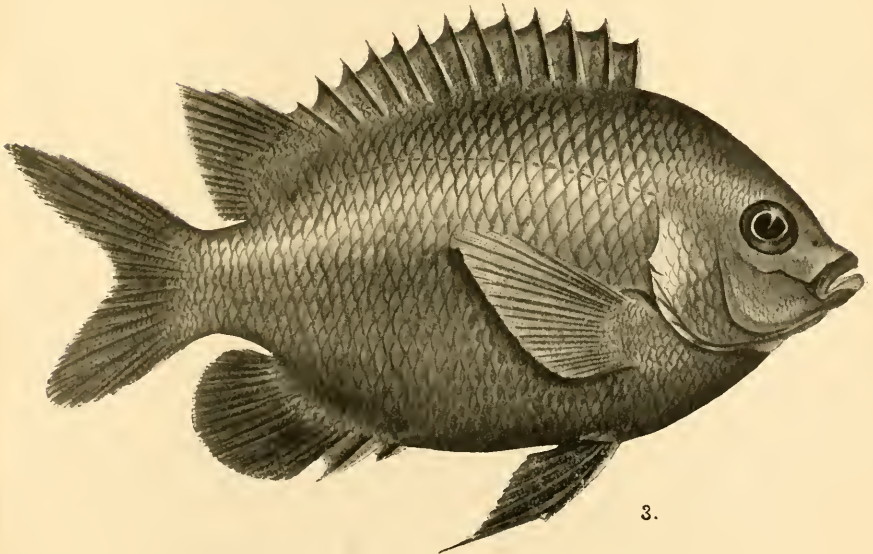
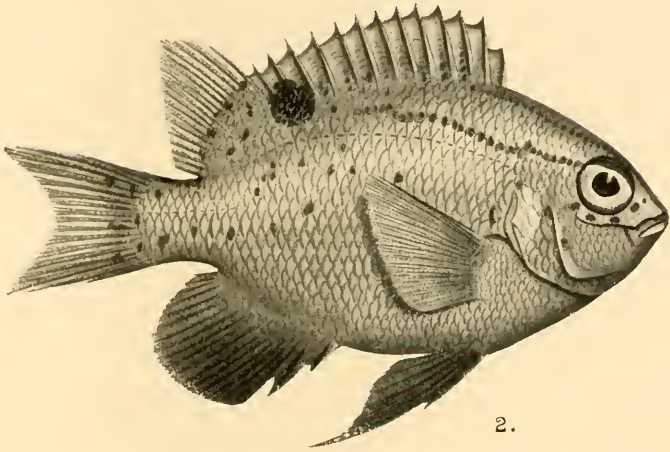
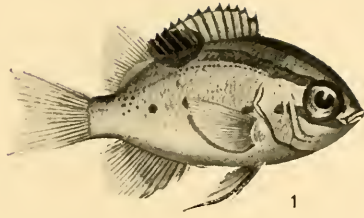





EXPLANATION OF PLATE XIII.

---

*Pseudolabrus punctulatus*, Günther.

(Seven-tenths natural size.)

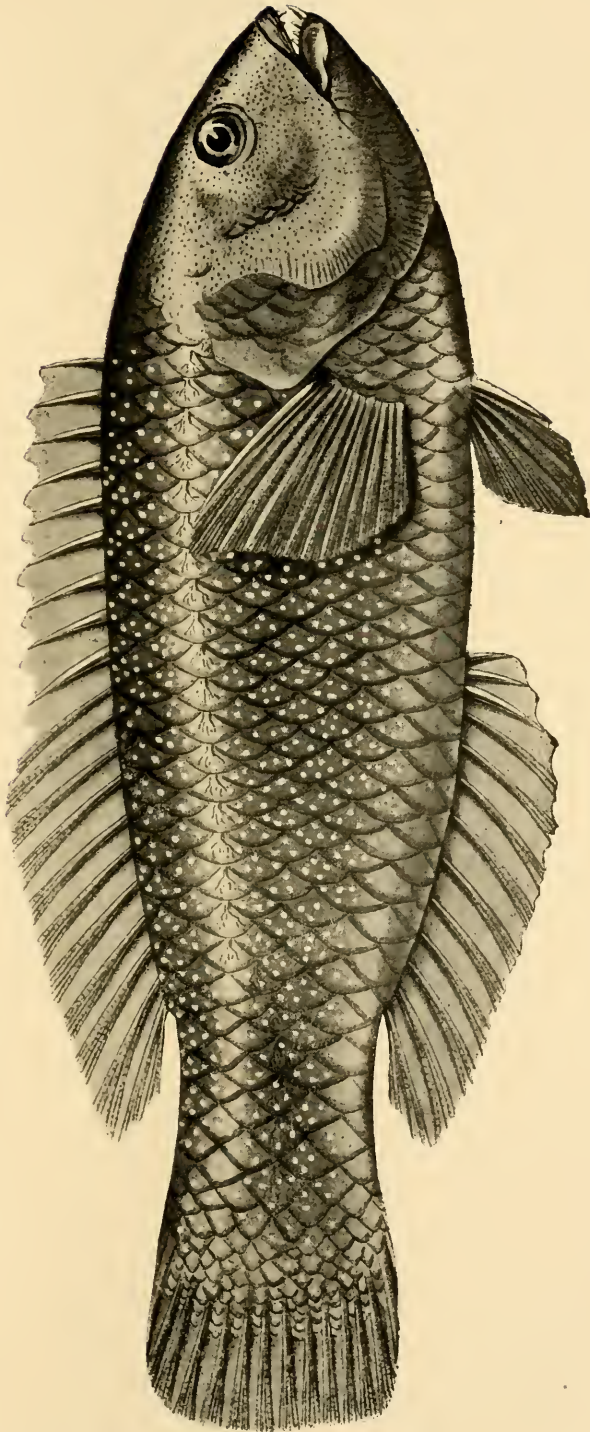





EXPLANATION OF PLATE XIV.

---

*Bramichthys woodwardi*, Waite.

(Slightly reduced.)



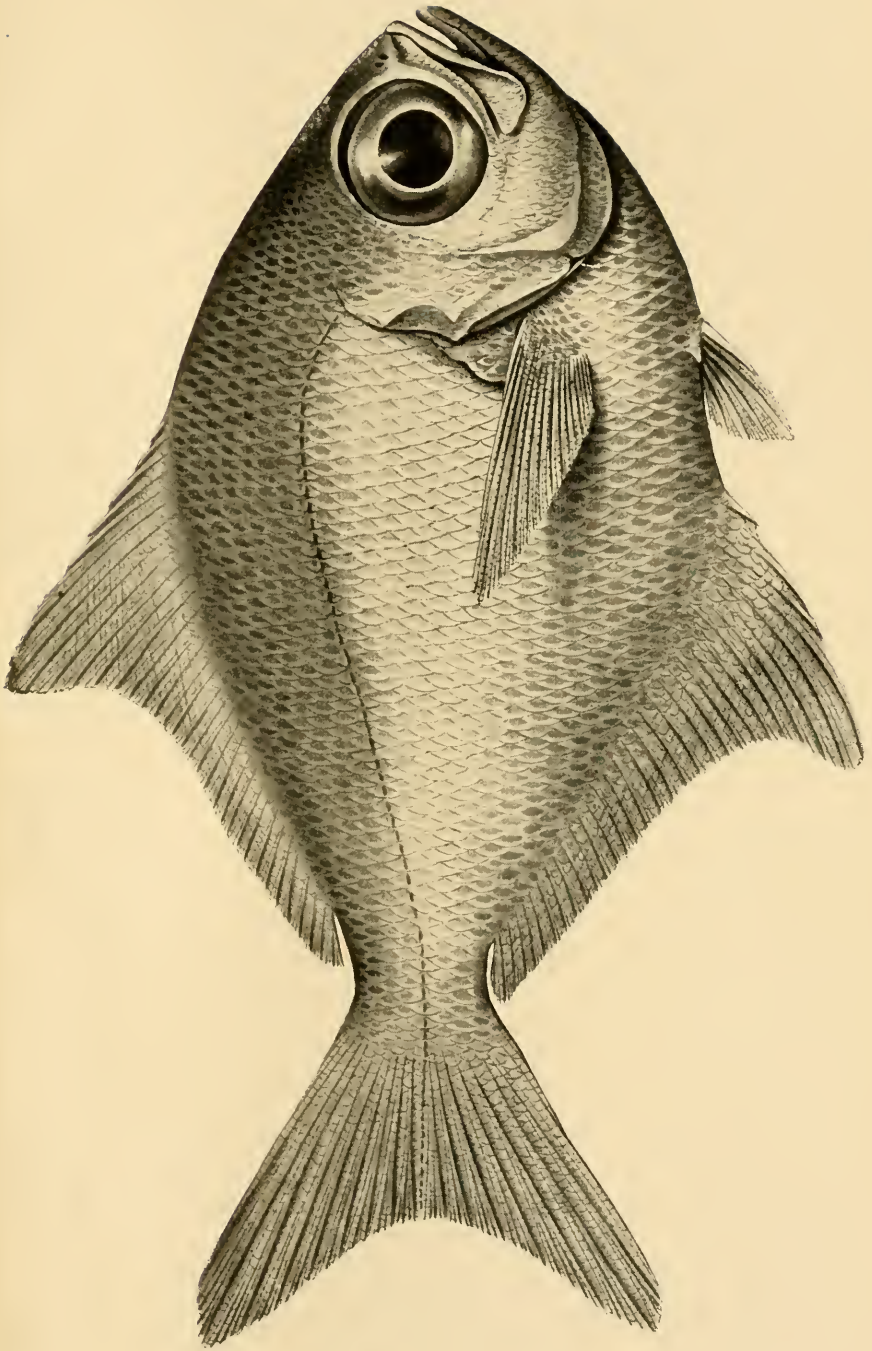

A. R. McCULLOCH, del.,  
Austr. Mus.





EXPLANATION OF PLATE XV.

---

*Pataeus maculatus*, Günther.

(Natural size.)







EXPLANATION OF PLATE XVI.

---

*Pseudomonacanthus gali*, Waite.

(Five-eighths natural size.)



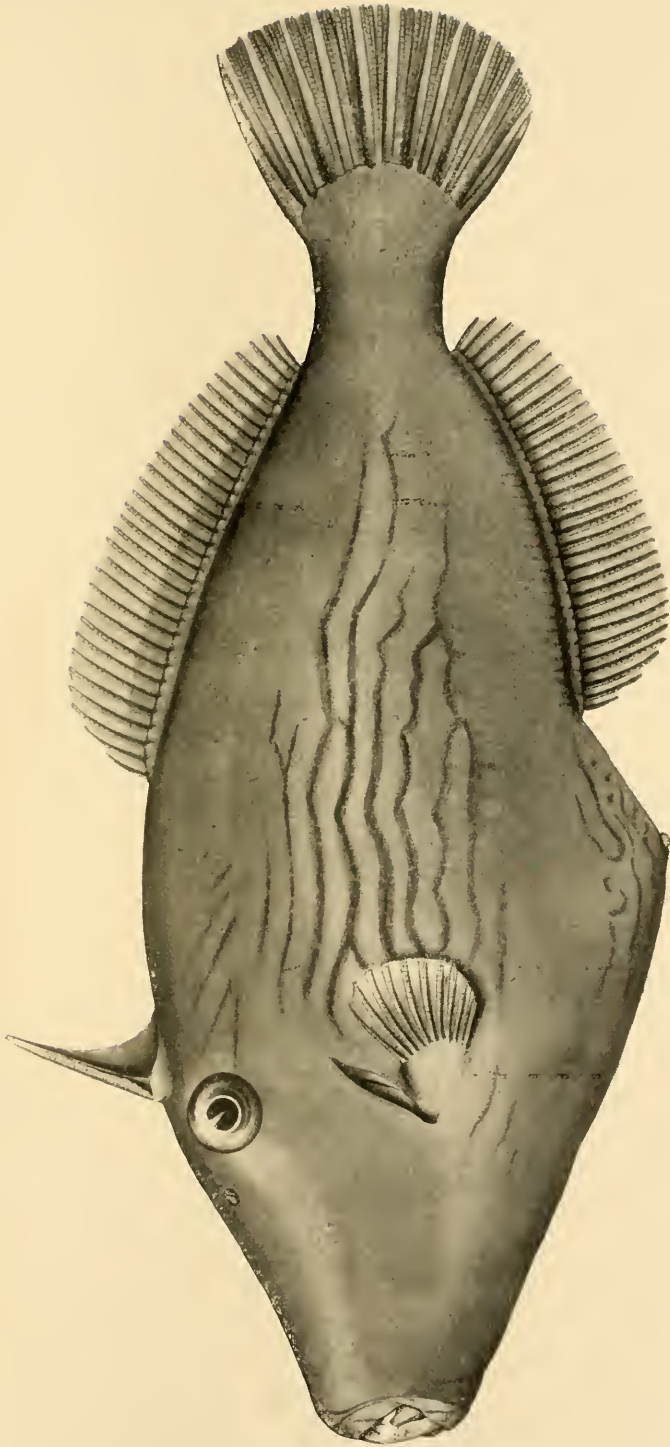





EXPLANATION OF PLATE XVII.

---

*Chætodermis maccullochi*, Waite.

(Five-sixths natural size.)

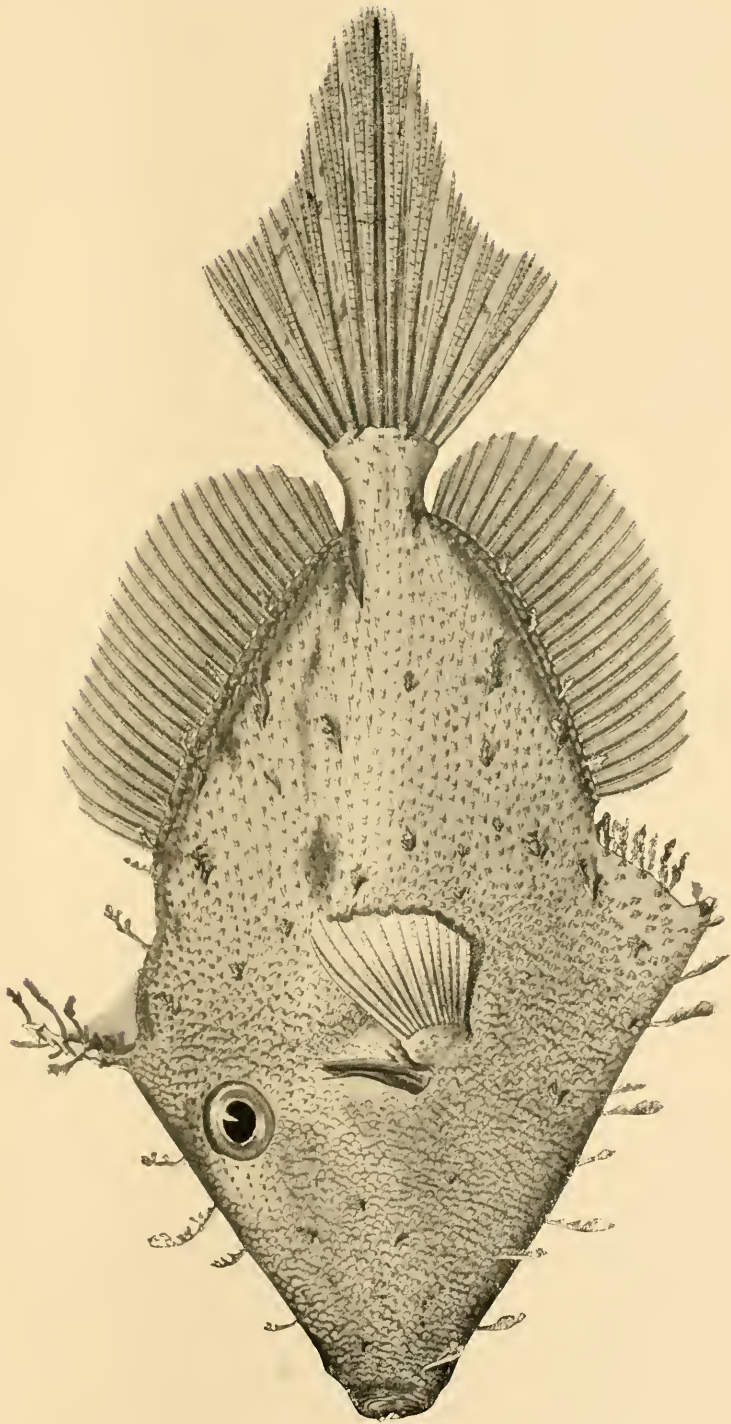





EXPLANATION OF PLATE XVIII.

---

TOPAZ.

Fig. 1. Emmaville, New South Wales.

Fig. 2. Oban, New South Wales.

Figs. 3, 4. Mount Cameron, Tasmania.

Fig. 5. Flinders Island, Tasmania.

Fig. 6. Bell Mount, Tasmania.

Forms:—*c* (001), *b* (010), *m* (110), *M* (230), *l* (120),  $\pi$  (250), *g* (130),  
*d* (201), *h* (203), *X* (043), *f* (021), *y* (041), *o* (221), *u* (111), *i* (223),  
*x* (243).



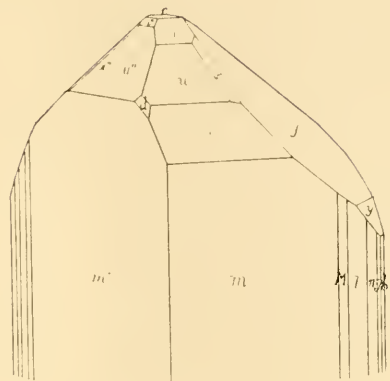

1

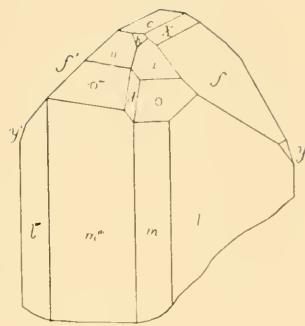

2

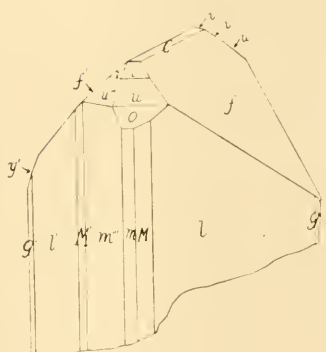

3

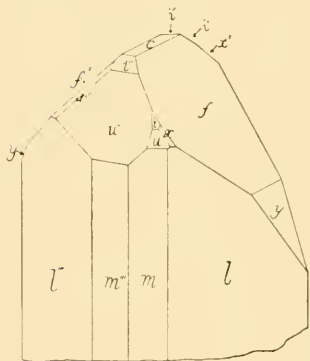

4

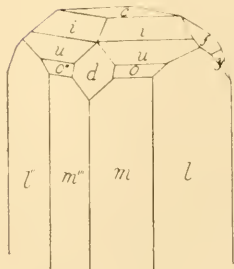

5

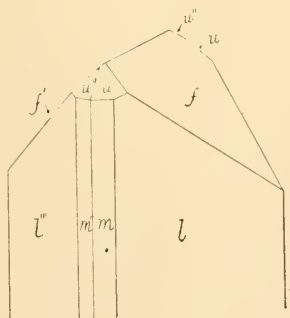

6





EXPLANATION OF PLATE XIX.

---

TOPAZ.

- Fig. 1. Emmaville, New South Wales. Stereogram showing all the recognized forms and the principal zones.

BARITE.

- Fig. 2. St. Peter's, near Sydney, New South Wales.  
Forms and indices as in Anglesite below.

ANGLESITE.

- Fig. 3. Maestrie's Mine, Dundas, Tasmania.  
Fig. 4. Mine Meretrice, New Caledonia.  
Figs. 5, 6. Lewis Ponds, New South Wales.

Forms:—*c* (001), *b* (010), *a* (100), *m* (110), *d* (102), *o* (011), *z* (111),  
*y* (122).

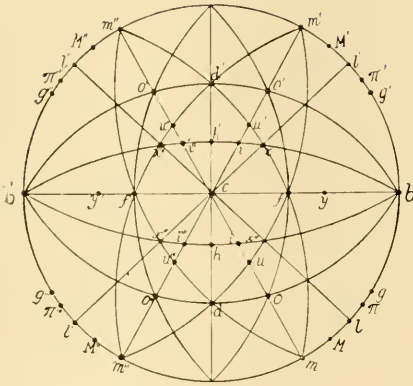

1

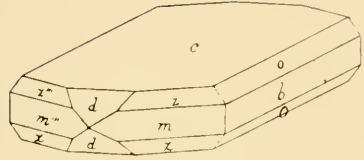

2

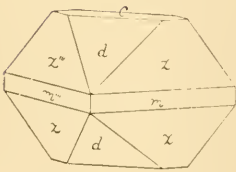

6

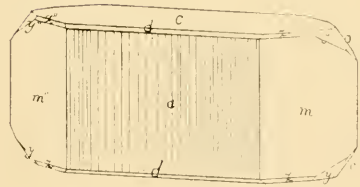

3

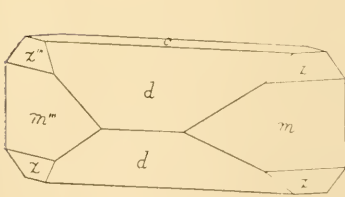

5

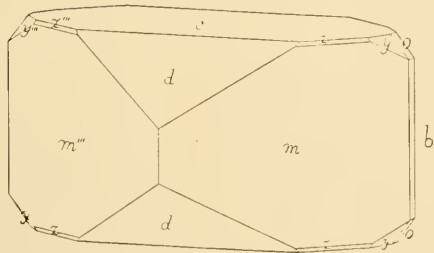

4





EXPLANATION OF PLATE XX.

CERUSSITE.

Figs. 1, 2, 3. Magnet Mine, Tasmania. The crystals are trillings on  $m$  (110). Fig. 3 is a stereogram shewing the distribution of the faces and the chief zones.

Forms:— $c$  (001),  $a$  (100),  $b$  (010),  $m$  (110),  $r$  (130),  $i$  (021),  $k$  (011),  
 $x$  (012),  $p$  (111).

ZIRCON

Fig. 4 Glen Innes, New South Wales.

Fig. 5 Inverell, New South Wales.

Fig. 6. Boat Harbour, Tasmania.

Forms — $a$  (100),  $m$  (110),  $p$  (111),  $r$  (221),  $u$  (331),  $x$  (131).



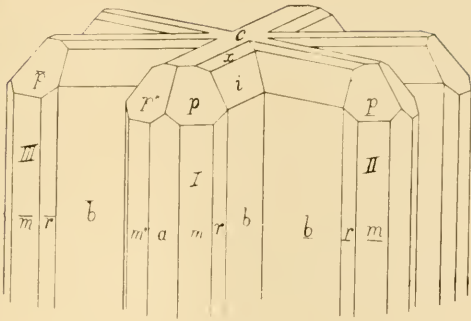

1

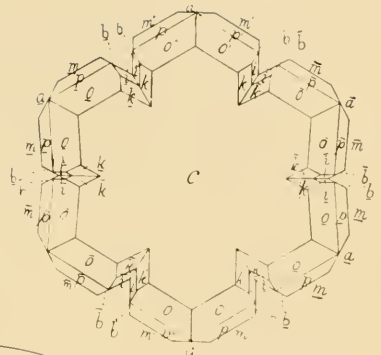

2

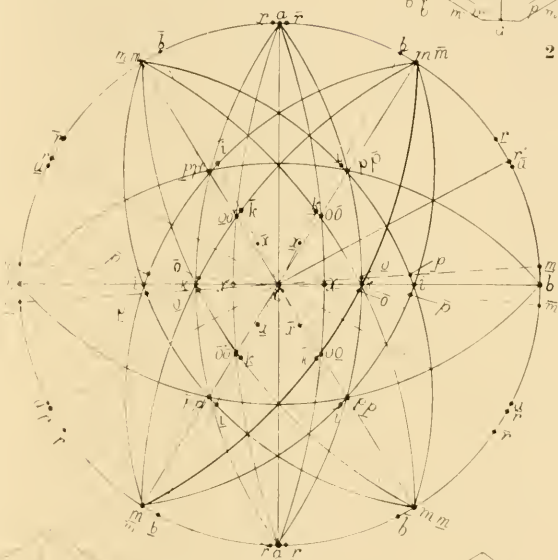

3



4

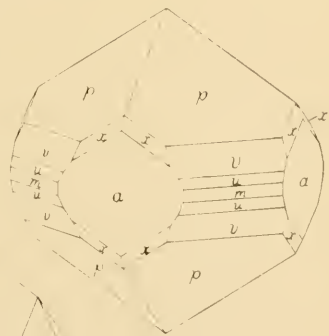

5



6





EXPLANATION OF PLATE XXI.

---

MEGALTRACTUS ARUANUS, L.

Torres Strait, about a quarter the natural size.

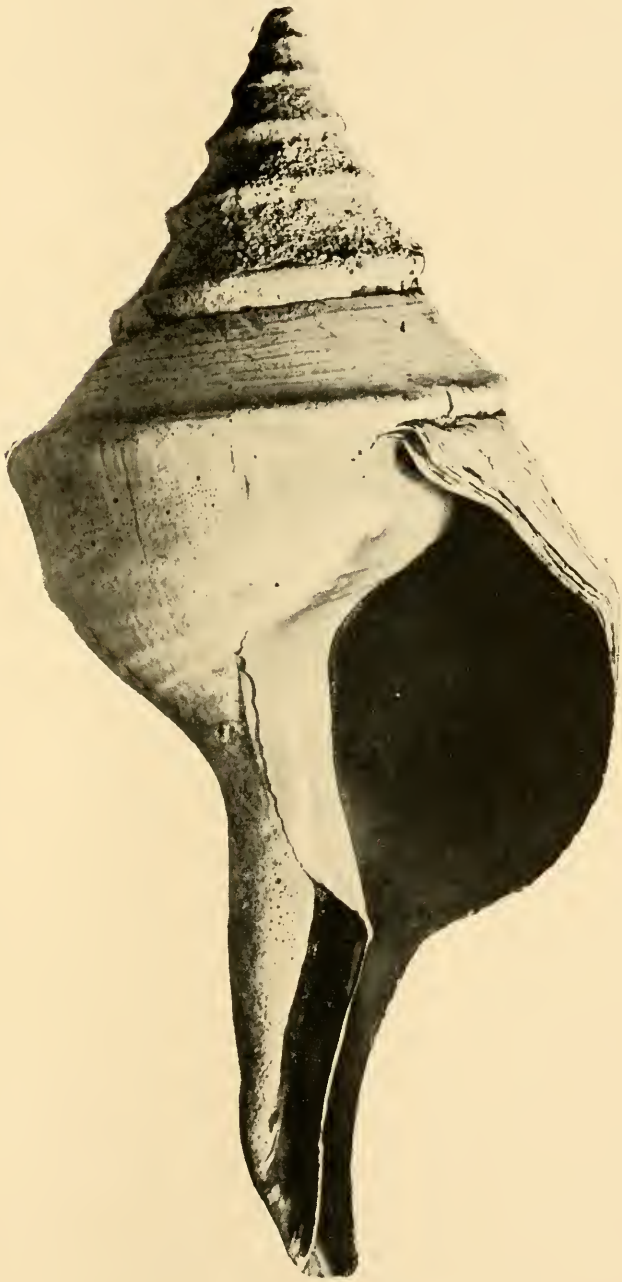





EXPLANATION OF PLATE XXII

---

MEGALATRACTUS ARUANUS.

Wellesly Islands, Gulf of Carpentaria, fashioned by natives to carry water, about a quarter the natural size.





T. WHITELEGGE, Photo.  
Austr. Mus.





EXPLANATION OF PLATE XXIII.

---

ECHIDNOPHAGA AMBULANS, *Olf.*

- Fig 1 Showing posterior abdominal segments rounded.  
" 2. " " " " " excavated.

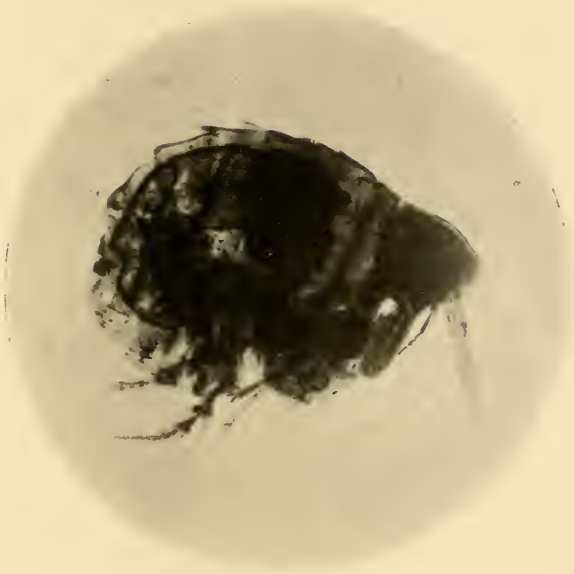

1

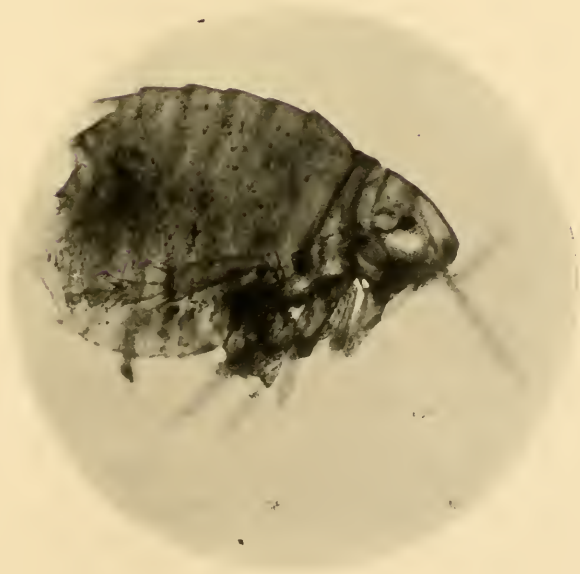

2





EXPLANATION OF PLATE XXIV

---

CARETTOCHELYS INSCULPTA, *Ramsay*.

Fig. 1. Carapace.

„ 2. Plastron.





1.

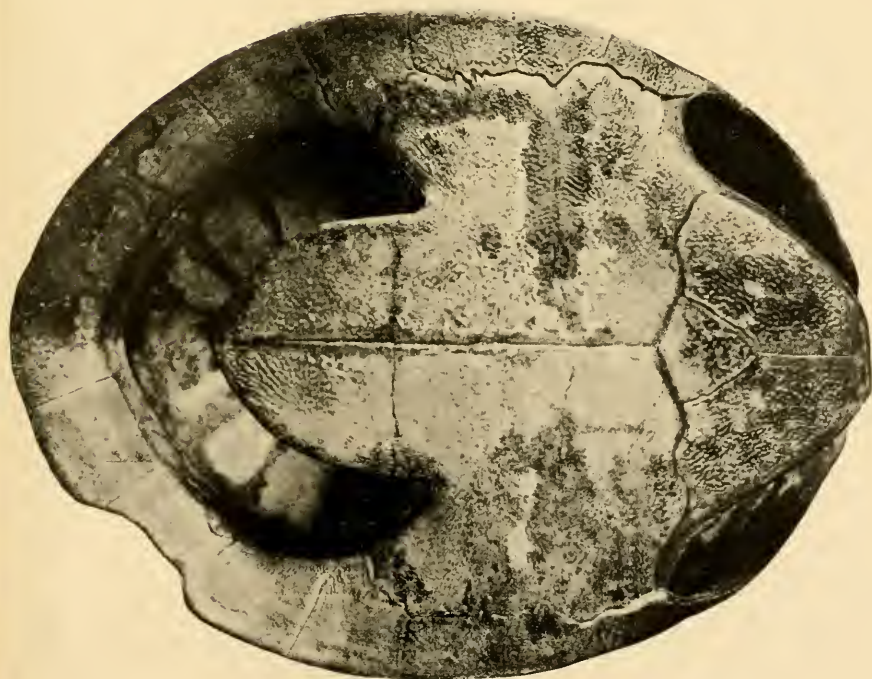

2.





EXPLANATION OF PLATE XXV.

---

CARETTOCHELYS INSCULPTA, *Ramsay*.

- Fig. 1. Head—Upper view.  
" 2. " Lower "  
" 3. " Lateral "

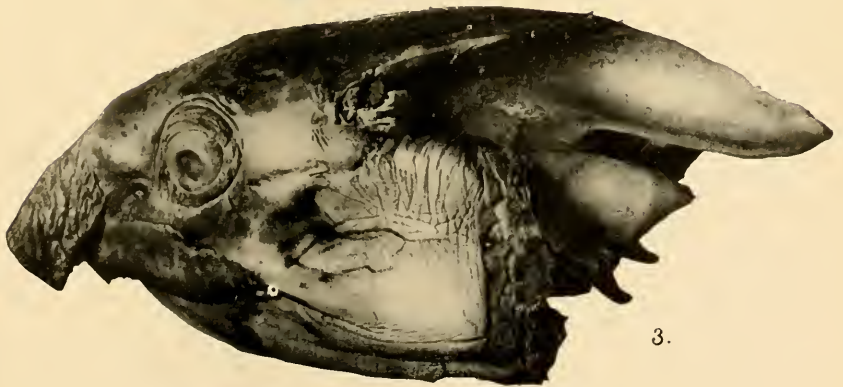





EXPLANATION OF PLATE XXVI.

---

CARETTOCHELYS INSCULPTA, *Ramsay*.

- Fig. 1. Skull—Upper view  
„ 2. „ Lower „  
„ 3. „ Lateral „



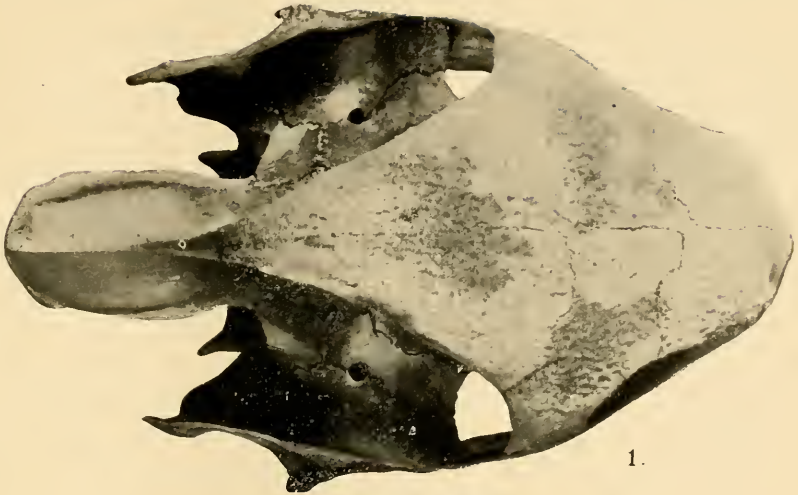

1.

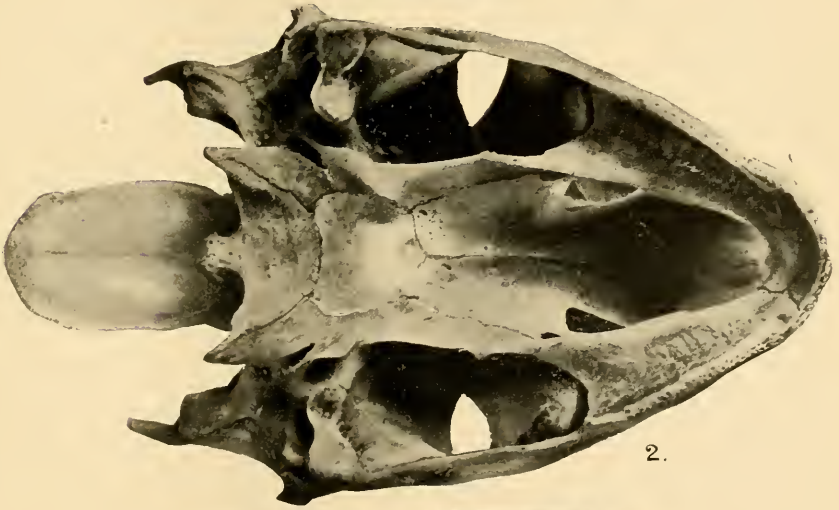

2.



3.





EXPLANATION OF PLATE XXVII.

---

CARETTOCHELYS INSCULPTA, *Ramsay*.

- Fig. 1. First Cervical Vertebra.  
„ 2. Second „ „  
„ 3. Third „ „  
„ 4. Eighth „ „  
„ 5. First Dorsal Vertebra and portion of Carapace.

*a.* Lateral; *b.* Dorsal; *c.* Ventral; *d.* Anterior; and *e.* Posterior aspects.

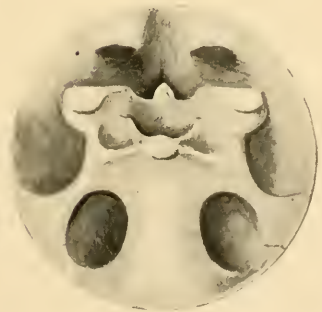
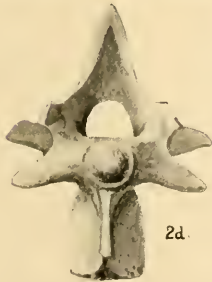
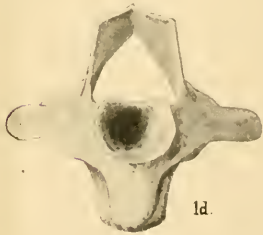
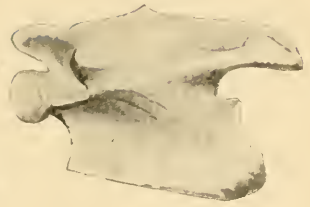





EXPLANATION OF PLATE XXVII.

---

Mural Tablet in S. James Church, Sydney, erected in memory of John Gilbert, Ornithologist.









EXPLANATION OF PLATE XXVIII.

---

*GANORHYNCHUS SUSSMILCHI, Eth. fil.*

- Fig. 1. Buckler seen from above.  
" 2. " " " the side.  
" 3. Snout seen from in front.  
" 4. " " " below.  
" 5. Portion of granulated plate on the same matrix.







EXPLANATION OF PLATE XXIX.

---

AXINITE.

Bowling Alley Point, Nundle, New South Wales.

Fig. 1. Clinographic drawing of ideal crystal (the unlettered face is  $r$ ).

" 2. Plan of fig. 1.

Figs. 3, 4. Clinographic drawings of natural crystals.

Fig. 5. Stereogram.

Forms:— $c$  (001),  $b$  (010);  $m$  (110),  $M$  ( $\bar{1}\bar{1}0$ ),  $w$  ( $1\bar{3}0$ );  $f$  (011),  $y$  (0 $\bar{2}$ 1),  
 $s$  (201);  $x$  (111),  $r$  ( $1\bar{1}1$ ),  $z$  ( $1\bar{1}2$ ),  $u$  ( $1\bar{3}1$ ),  $o$  ( $\bar{1}32$ ),  $\Gamma$  ( $\bar{1}31$ ),  $d$  ( $2\bar{4}1$ ).



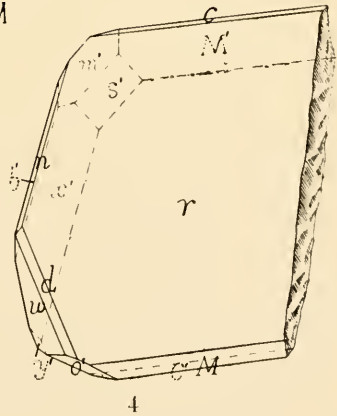
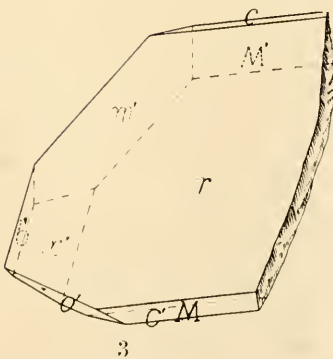
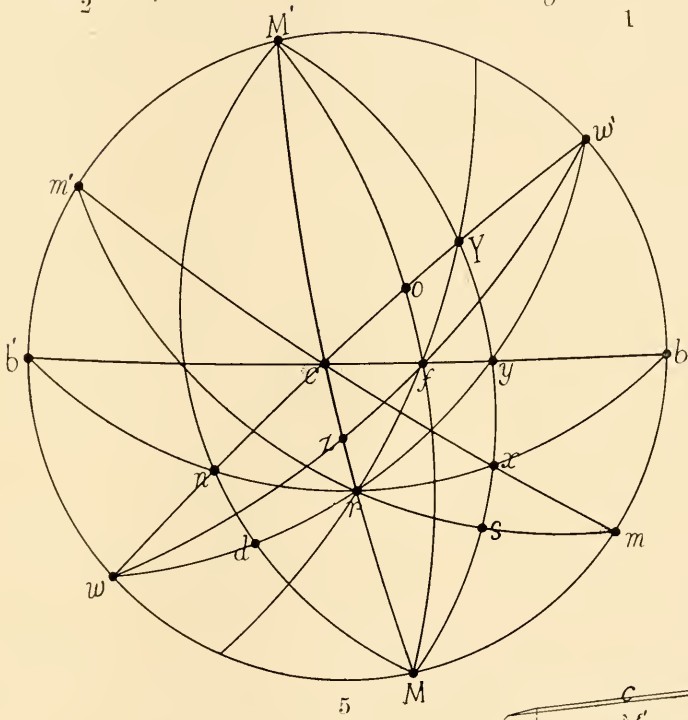
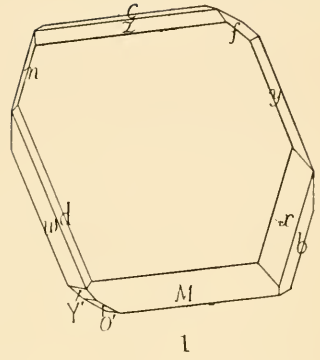
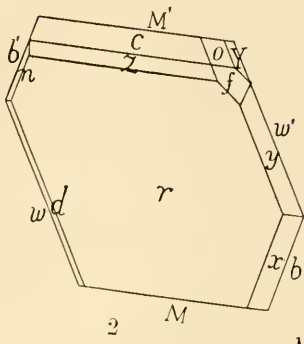





EXPLANATION OF PLATE XXX.

---

AXINITE.

Colebrook Mine, Dundas, Tasmania.

Fig. 1. Clinographic drawing of ideal crystal.

„ 2. Plan of fig. 1.

Forms :— $a$  (100),  $X$  ( $0\bar{2}1$ ),  $\delta$  ( $1\bar{3}2$ ),  $q$  ( $\bar{1}51$ ). [Other forms as in Explanation to Pl. xxix.].

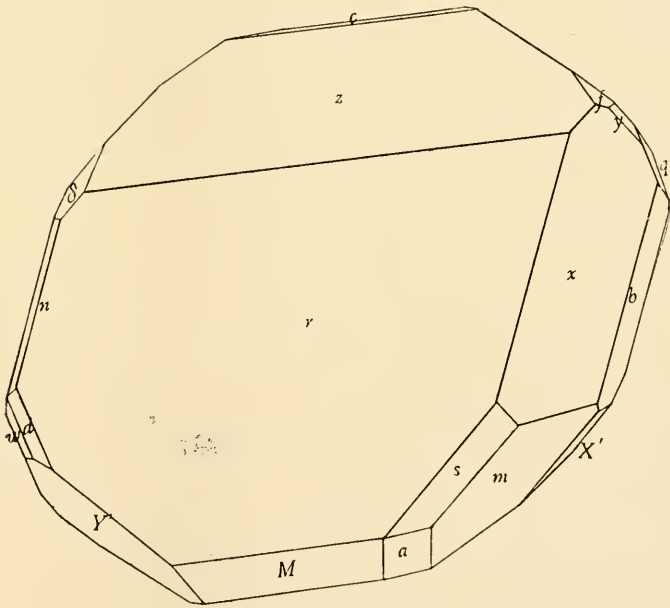
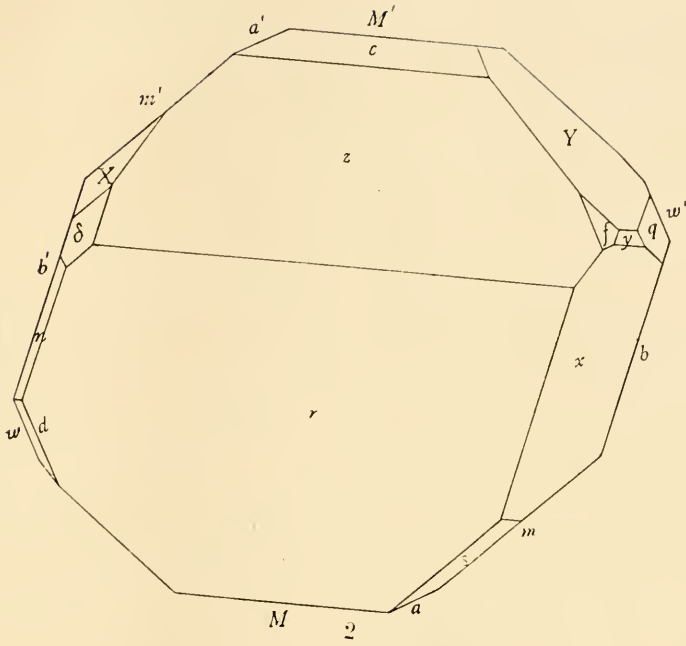





EXPLANATION OF PLATE XXXI.

---

AXINITE.

Figs. 1,2. Moonbi, New South Wales.

Fig. 3. Colebrook Mine, Dundas, Tasmania.

[For lettering see Explanation to Plates xxix. and xxx.]

PETTERDITE (= MIMETITE).

Fig. 4. Britannia Mine, Zeehan, Tasmania.

Forms:— $c$  (0001),  $m$  ( $10\bar{1}0$ ),  $x$  ( $10\bar{1}1$ ),  $s$  ( $11\bar{2}1$ ).

CROCOITE.

Fig. 5. Magnet Mine, Tasmania.

Forms:— $b$  (010),  $m$  (110),  $l$  (111),  $v$  ( $\bar{1}11$ ),  $k$  ( $\bar{1}01$ ).



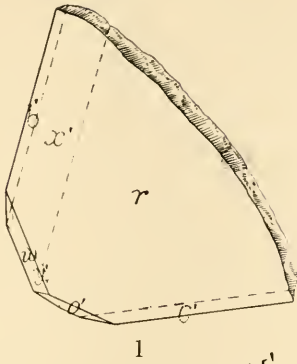

1

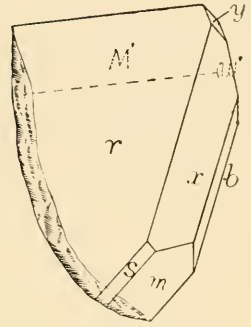

2

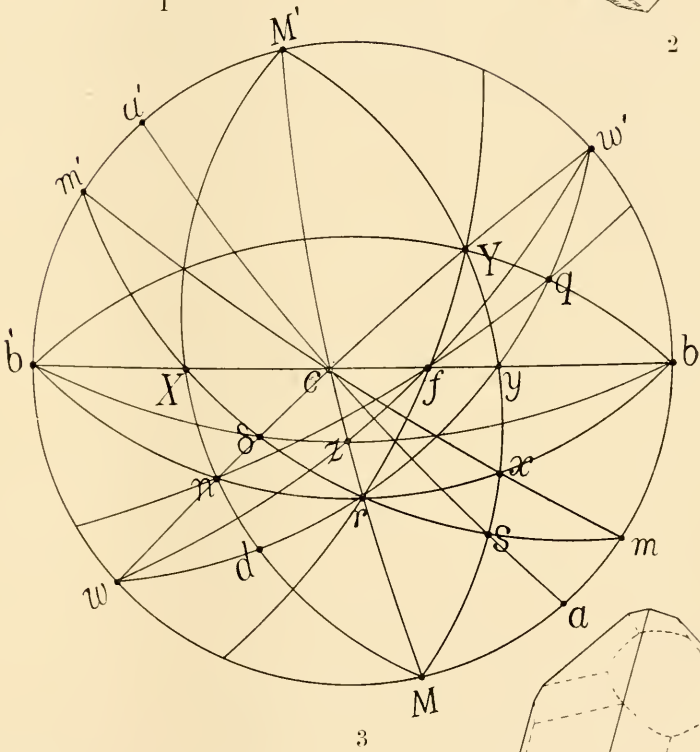

3

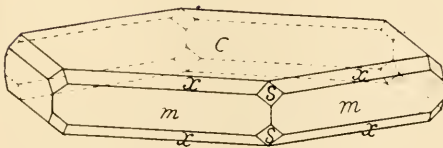

4

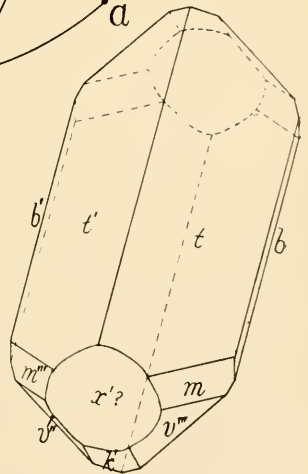

5





EXPLANATION OF PLATE XXXII.

---

PETTERDITE (= MIMETTE).

Britannia Mine, Zeehan, Tasmania, enlarged about one-half.

(By permission of Mr. W. F. Petterd).



H. BARNES, Junr., photo,  
Austr. Mus.





EXPLANATION OF PLATE XXXIII.

---

DATOLITE.

Colebrook Mine, Dundas, Tasmania.

- Fig. 1. Clinographic drawing of ideal crystal.  
,, 2. Plan of fig. 1.  
,, 3. Clinographic drawing of natural crystal.  
,, 4. Plan of fig. 3.  
,, 5. Stereogram.

Forms:— $c$  (001),  $a$  (100);  $m$  (110);  $m_x$  (011),  $t$  (013),  $x$  (102);  $n$  (111),  $\kappa$  ( $\bar{1}15$ ),  $\mu$  ( $\bar{1}14$ ),  $\lambda$  ( $\bar{1}13$ ),  $\epsilon$  ( $\bar{1}12$ ),  $\iota$  ( $\bar{2}12$ ),  $\pi$  ( $\bar{2}31$ ).



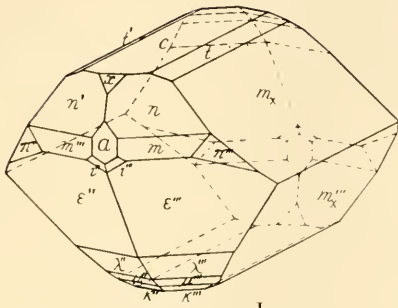

1

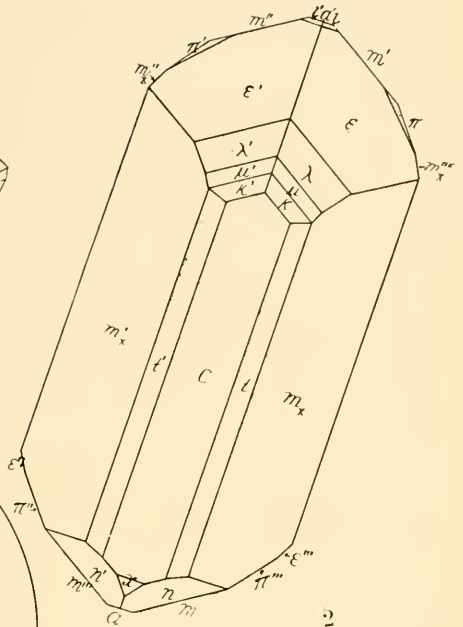

2

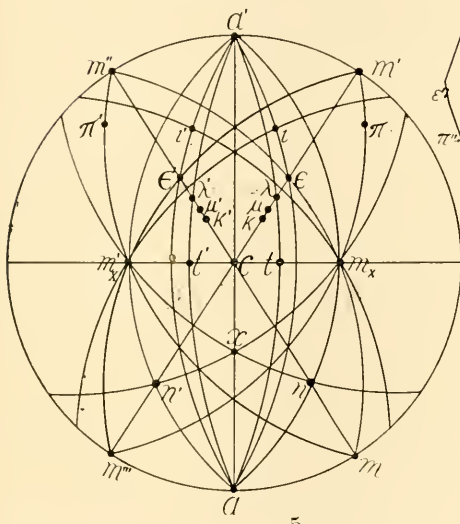

3

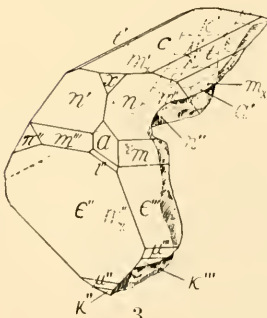

3

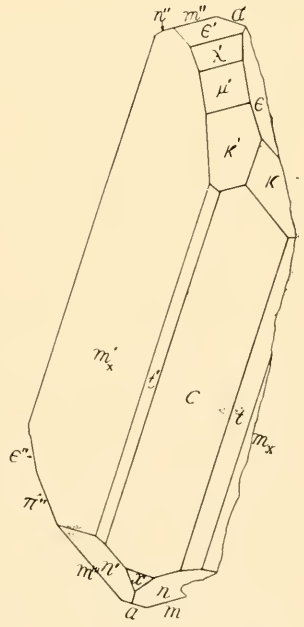

4





EXPLANATION OF PLATE XXXIV.

---

*Peltorhamphus basseusis*, Castelnau.  
(Five-sixths natural size).

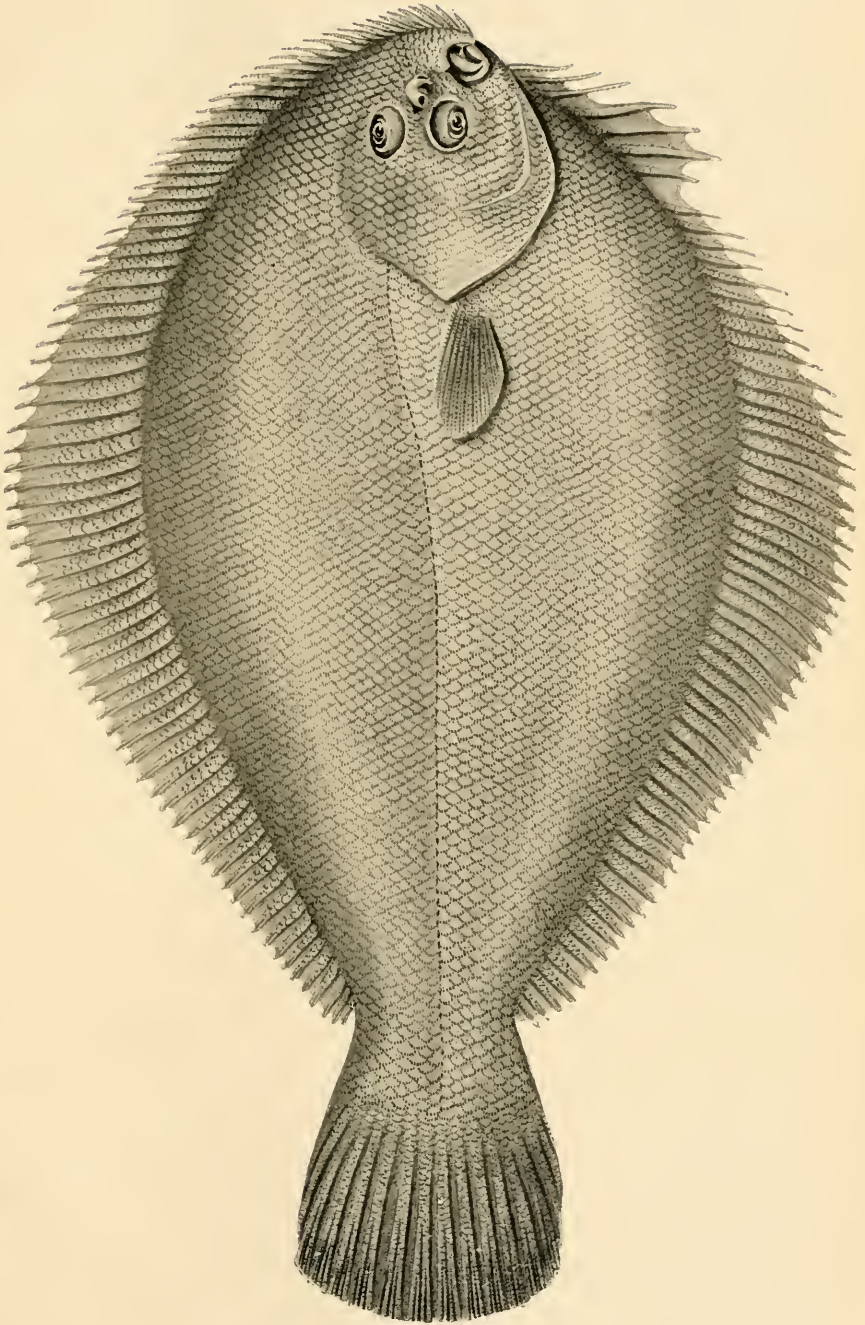

A. R. McCULLOCH, del.,  
Austr. Mus.





EXPLANATION OF PLATE XXXV.

---

*Rhombosolea flesoides*, Günther.

(Four-fifths natural size).



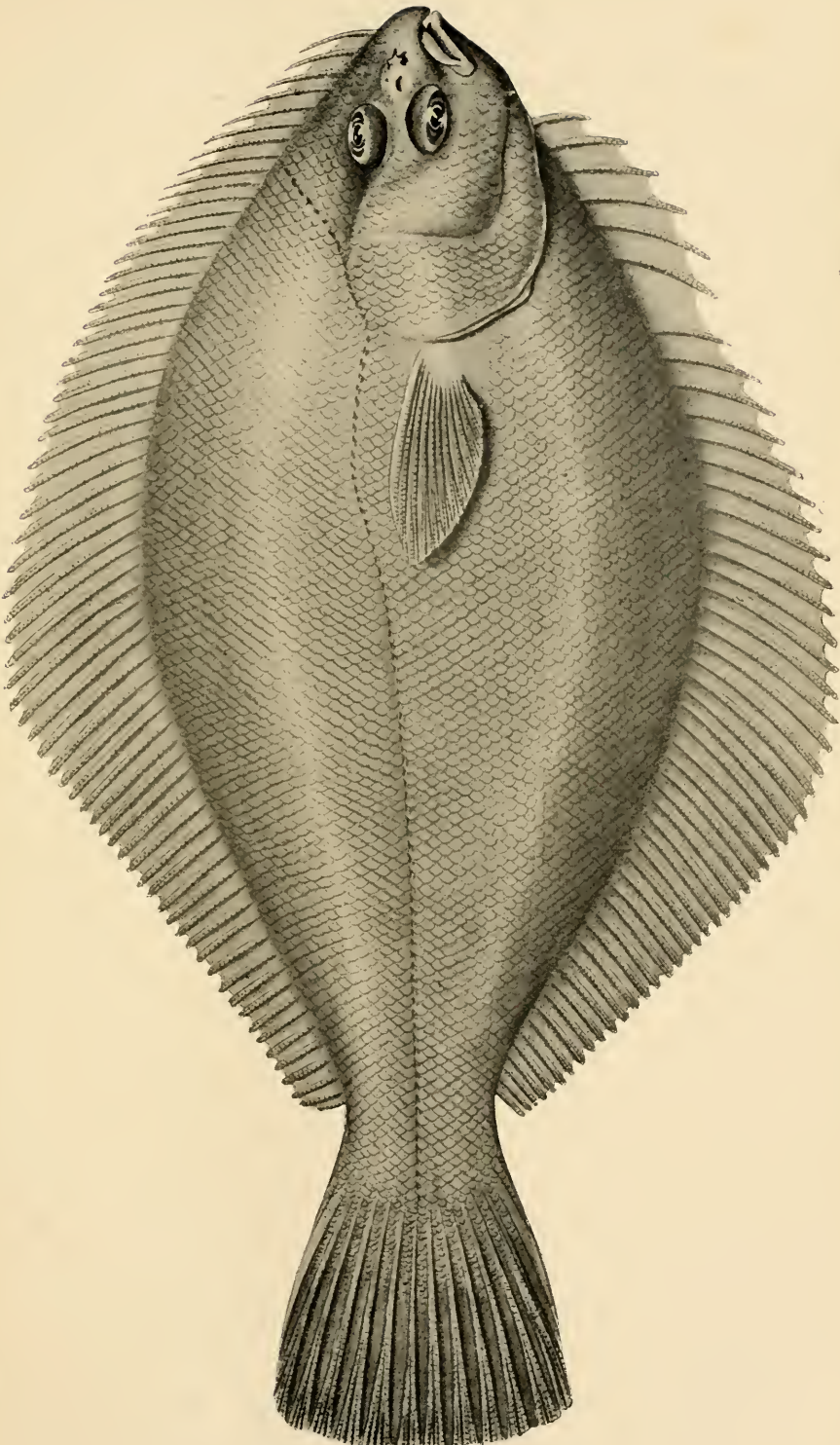

A. R. McCULLOCH, del.,  
Austr. Mus.





EXPLANATION OF PLATE XXXVI.

---

- Fig. 1. *Cheilobranchus rufus*, Macleay.  
,, 2. *Crepidogaster spatula*, Günther.  
,, 3. *Diplocrepis parvipinnis*, Waite.  
,, 4. " *cardinalis*, Ramsay.  
,, 5. *Blennius tasmanianus*, Richardson.  
,, 6. *Ophioclinus gabrieli*, Waite.  
,, 7. " *gracilis*, Waite.

(All the figures enlarged).

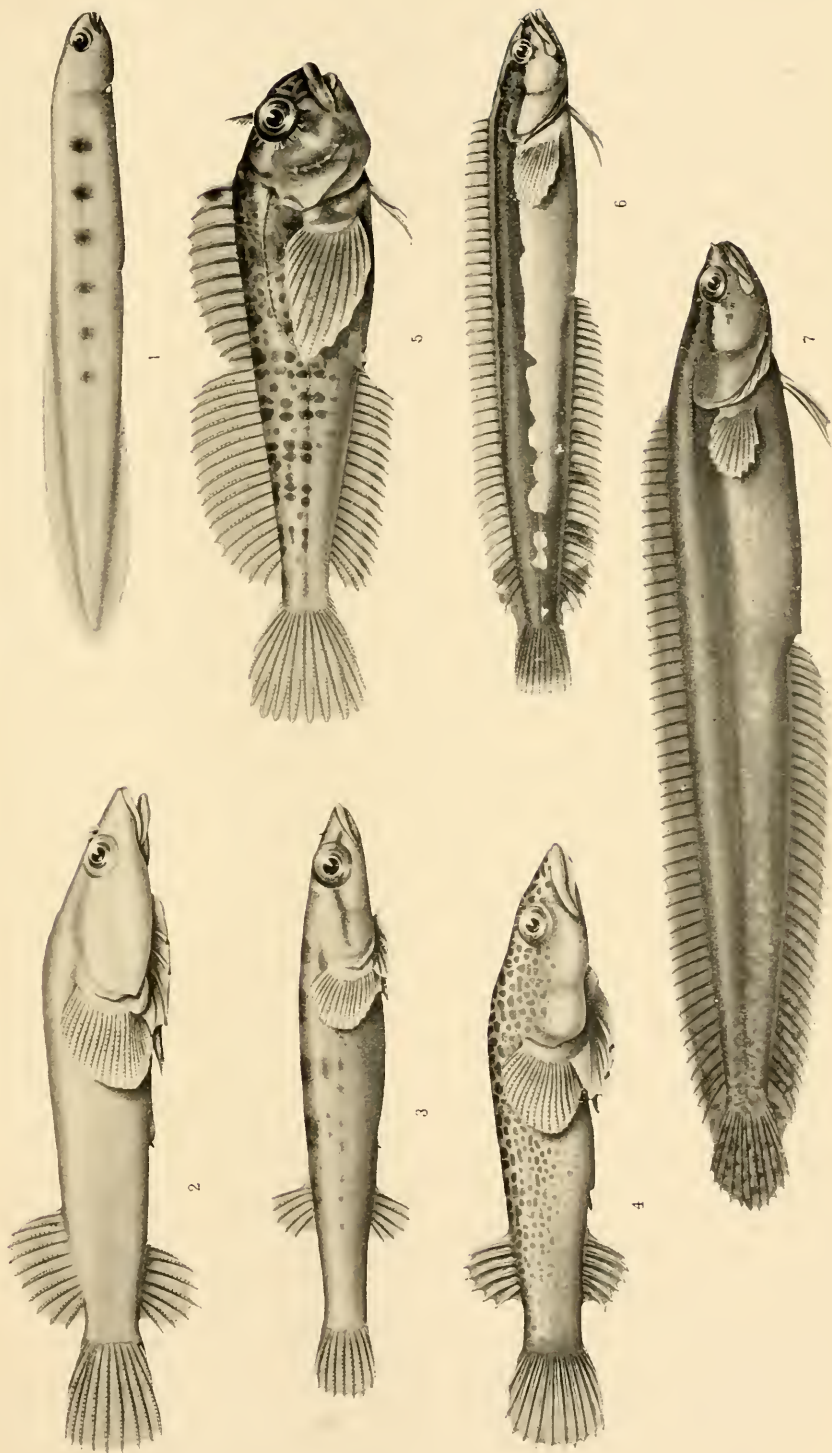

A. R. McCULLOCH, del.,  
Austr. Mus.





EXPLANATION OF PLATE XXXVII.

---

- Fig. 1. *Monilea oleacea*, Hedley and Petterd.  
,, 2. *Rissoa filocincta*, Hedley and Petterd.  
,, 3. *Bathytoma agnata*, Hedley and Petterd.  
,, 4. *Cerithiopsis cacuminatus*, Hedley and Petterd.  
,, 5. *Pleurotoma casearia*, Hedley and Petterd.  
,, 6. *Murex lacinus*, Hedley and Petterd.  
,, 7, 8. *Emarginula superba*, Hedley and Petterd.  
,, 9. *Terebra lauretanae*, Ten. Woods.



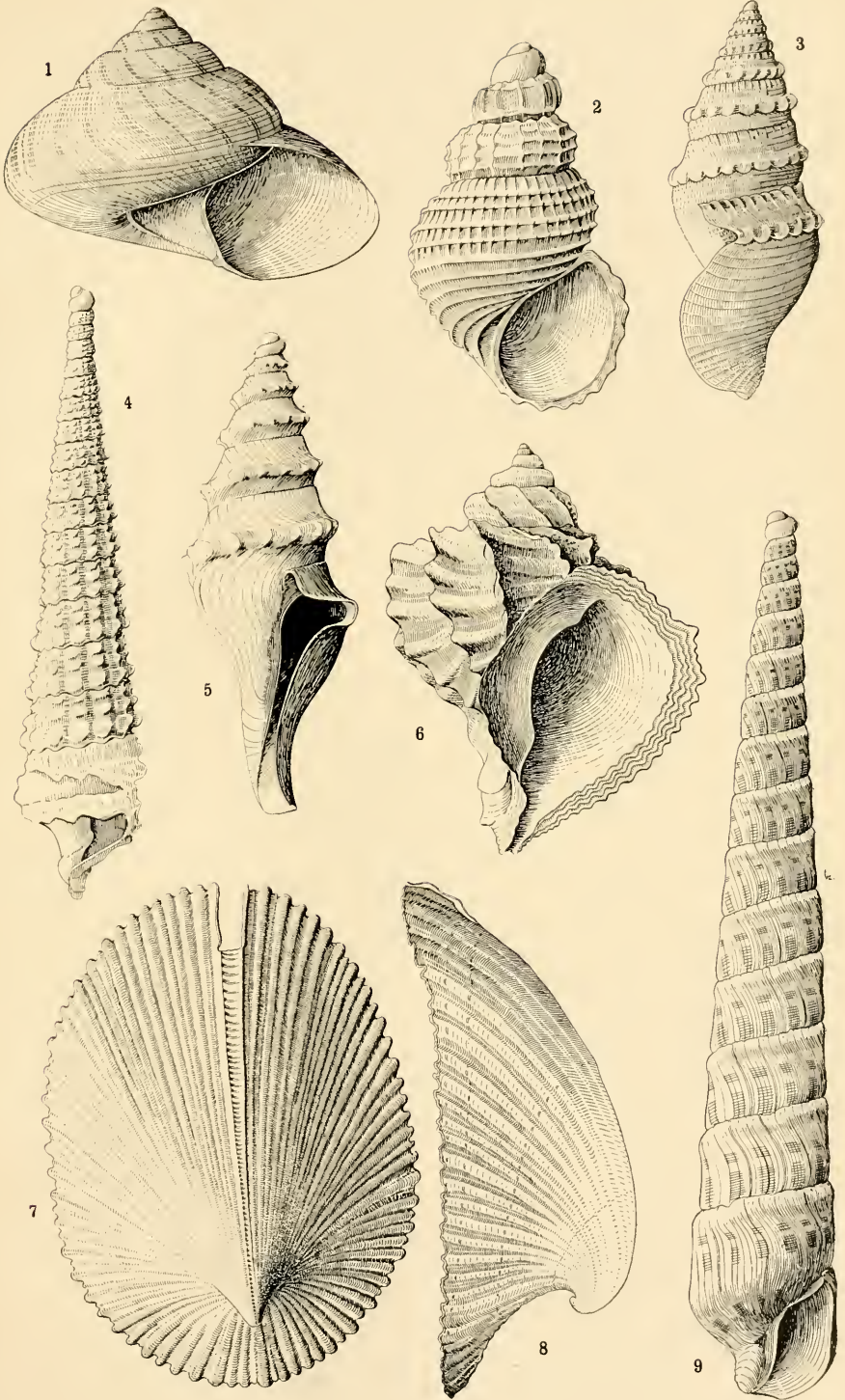

C. HEDLEY, del.,  
Austr. Mus.





EXPLANATION OF PLATE XXXVIII.

---

- Fig. 10. *Bittium fuscocapitulum*, Hedley and Petterd.  
" 11. " " " " " apex.  
" 12. *Cancellaria scobina*, Hedley and Petterd.  
" 13. *Tiberia nitidula*, A. Adams.  
" 14. *Limopsis erectus*, Hedley and Petterd.  
" 15. " " " " " hinge.  
" 16. *Poromya undosa*, Hedley and Petterd.  
" 17. " " " " " sculpture.  
" 18. *Amusium thetidis*, Hedley—interior of left valve.  
" 19. " " " " " exterior of left valve.

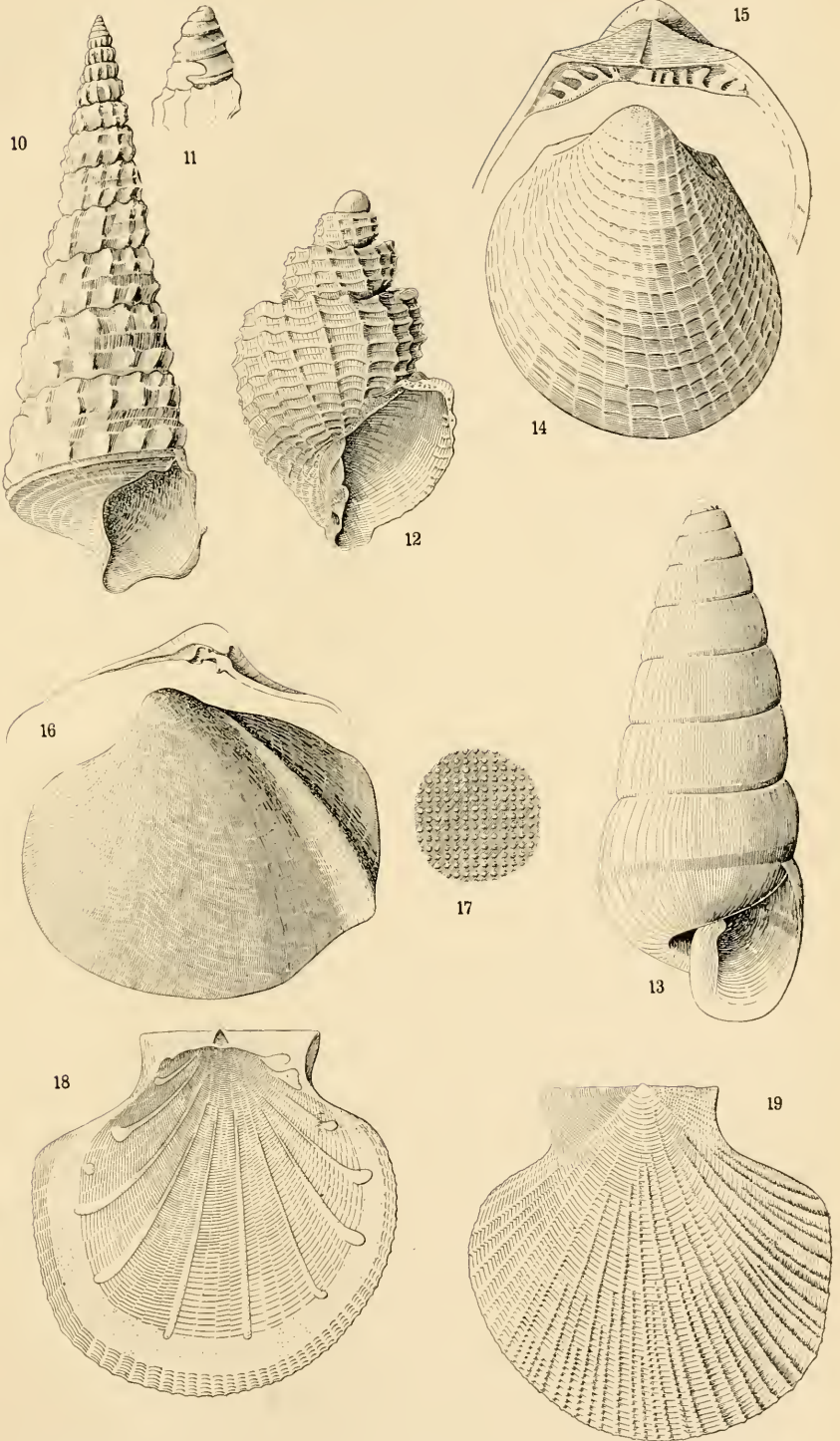





EXPLANATION OF PLATE XXXIX.

---

*Carcharias brachyurus*, Günther.  
(Two-ninths natural size).



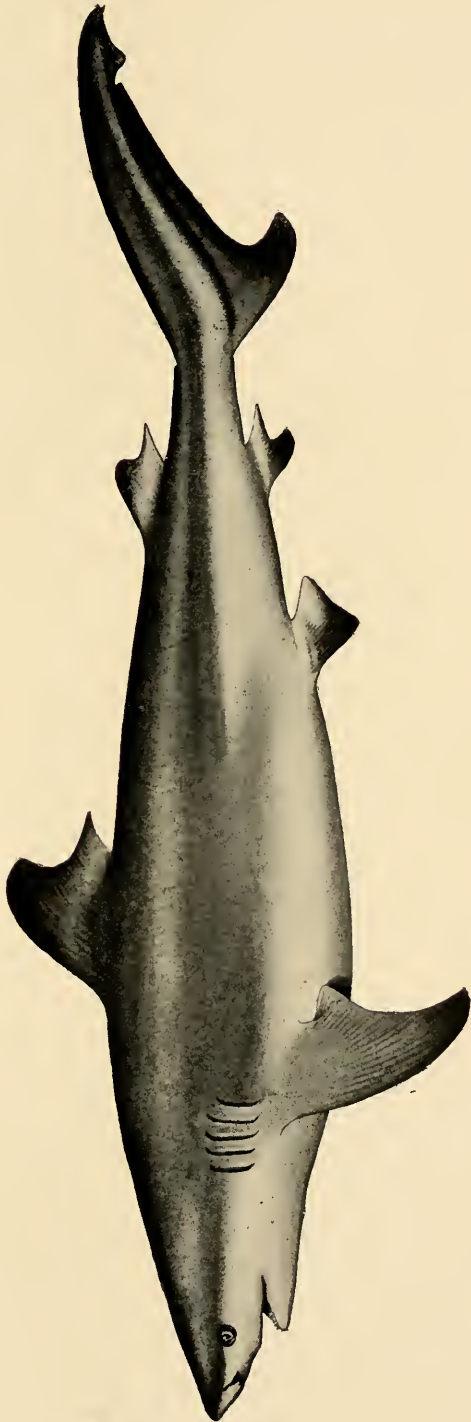

A. R. McCULLOCH, del.,  
Austr. Mus.





EXPLANATION OF PLATE XL.

---

*Catulus analis*, Ogilby—egg-case.  
(Natural size).



H. BARNES, Junr., photo.,  
Austr. Mus.





EXPLANATION OF PLATE XLI.

---

*Parascyllum collare*, Ramsay & Ogilby—egg-case.  
(Natural size).



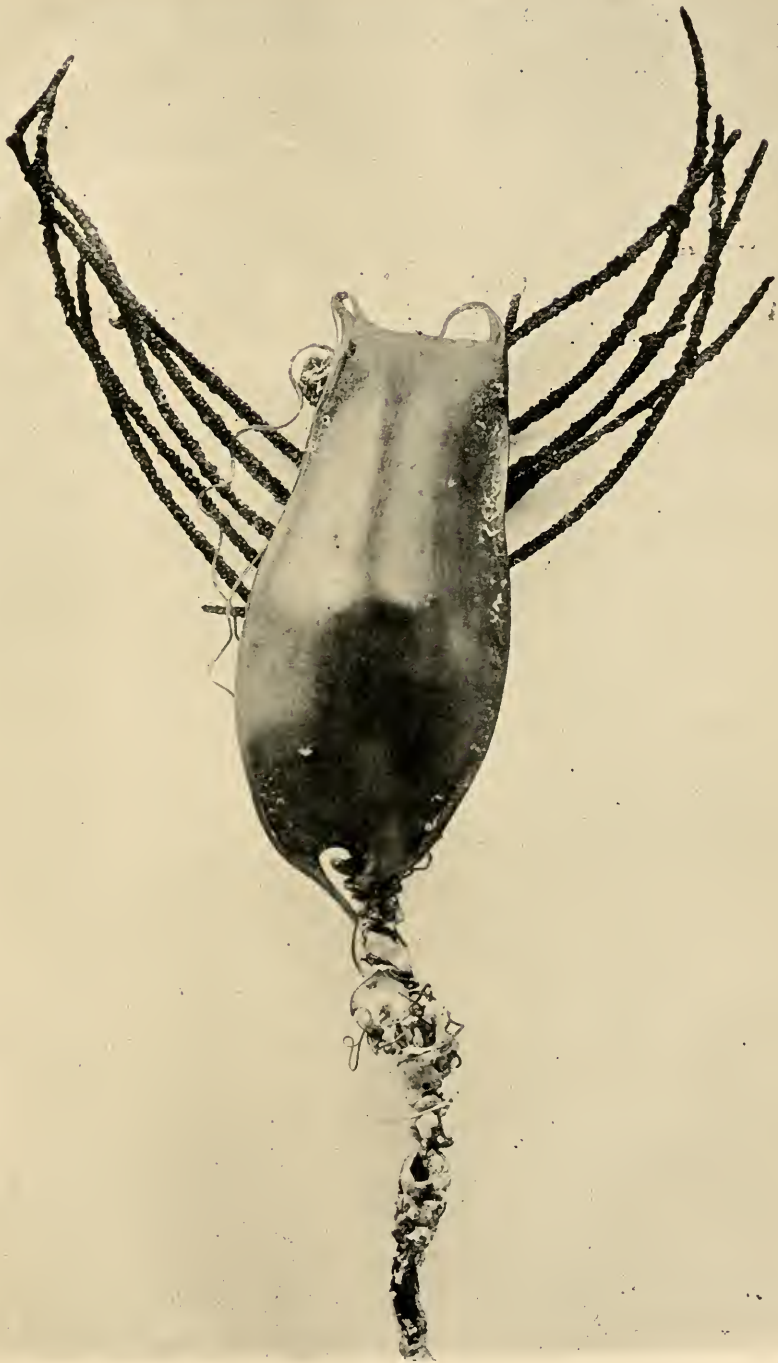





EXPLANATION OF PLATE XLII.

---

- Group 1—Figs. 1-5 and 7-9. Various shaped knives.  
,, 1—Fig. 6. Nose ornament.  
,, 1—Figs. 10-11. Gritty sandstone rasps.  
,, 2—Six rows of chipped-back surgical knives.  
,, 3—Two rows of minute, straight, slender points.  
,, 4—Eight rows of spear-heads or knives.

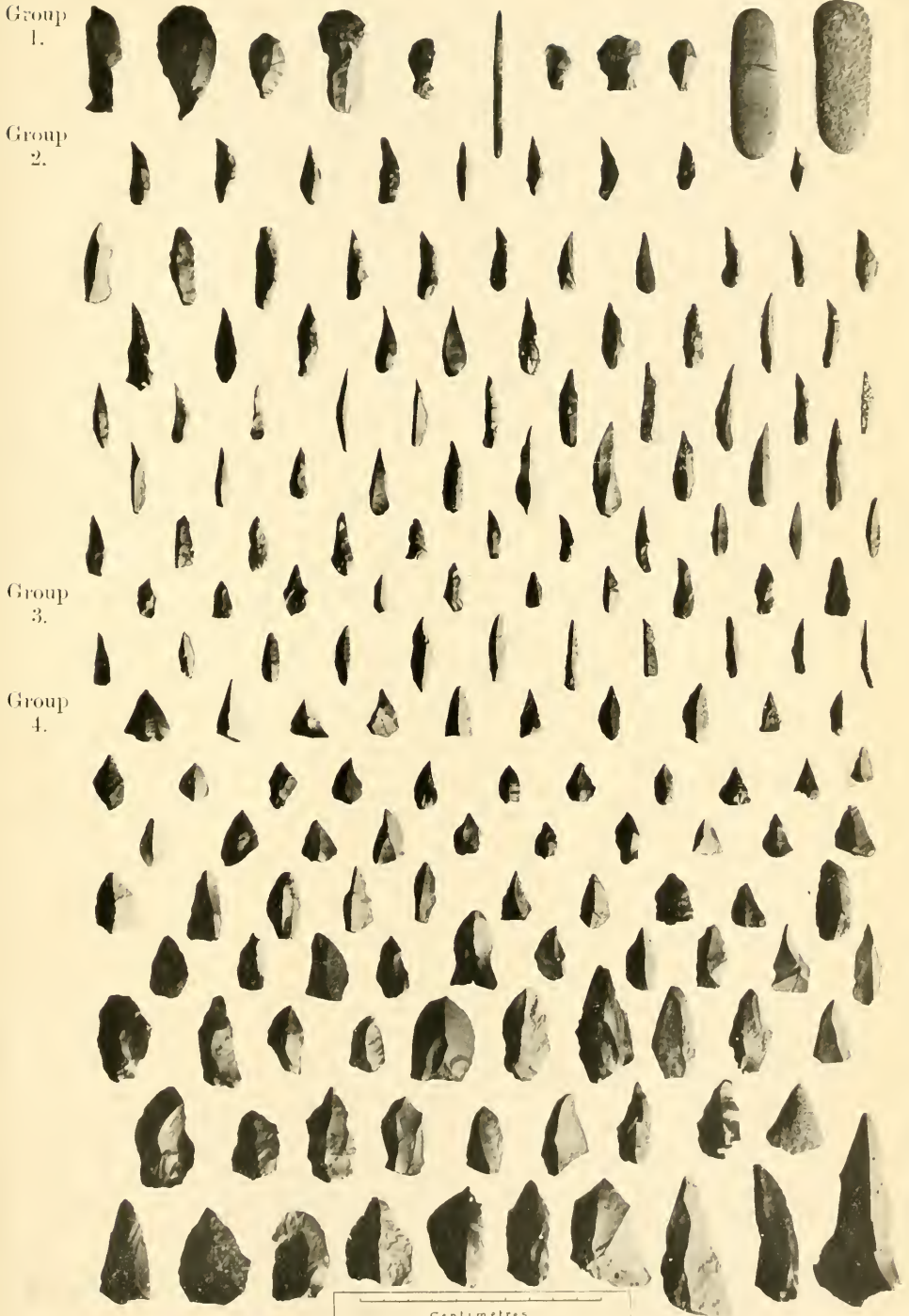





EXPLANATION OF PLATE XLIII.

Group 1—Nine rows of gravers.

„ 2—Five rows of adze-like pieces—possibly gouges.



Group  
1.

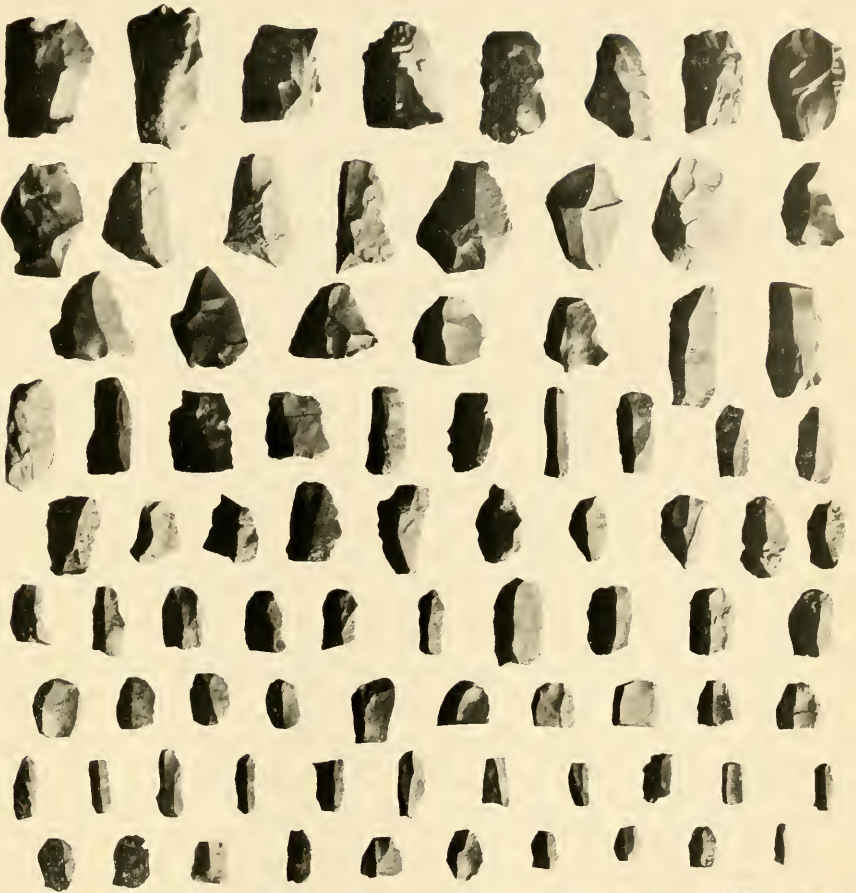

Group  
2.

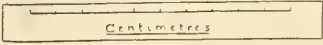





EXPLANATION OF PLATE XLIV.

---

- Group 1—Two rows of smooth scrapers.  
,, 2—Seven rows of death-spear points.  
,, 3—Four rows of irregularly-shaped knives.  
,, 4—Two rows of cores.  
,, 5—Four rows of worked scrapers.

Group  
1.

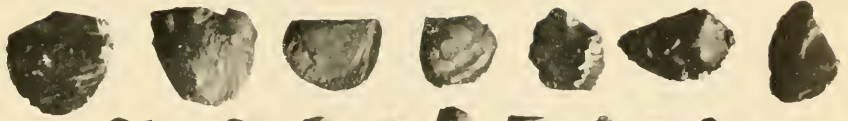

Group  
2.

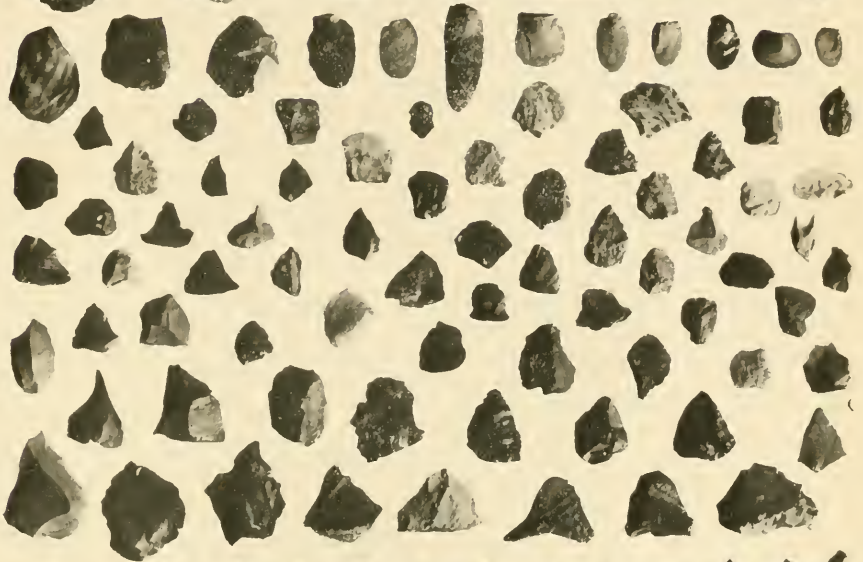

Group  
3.

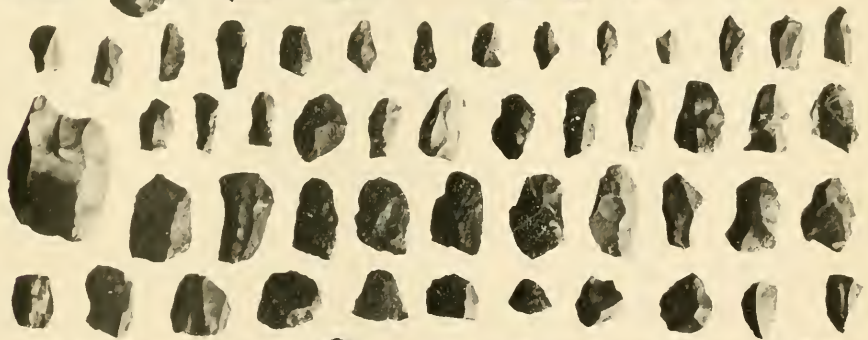

Group  
4.

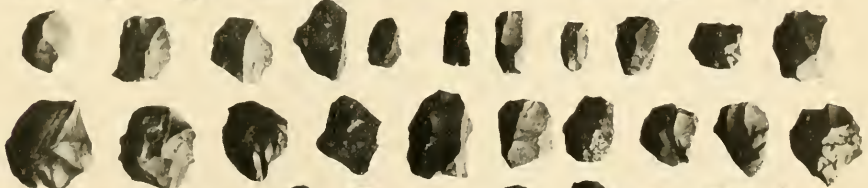

Group  
5.

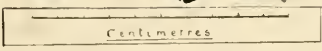





EXPLANATION OF PLATE XLV.

---

- No. 1—View of the principal sandhill at Bellambi looking towards the north-east.  
,, 2— Summit of the same looking north.  
,, 3— „ „ „ „ „ south.





1



2



3





## EXPLANATION OF PLATE XLVI.

### *Tubifex davidis*, Benham.

- Fig. 1. A dorsal bundle of chætæ from segment vi.  
,, 2. The outer moiety of a dorsal chætæ from one of the anterior segments, showing intermediate teeth. (Camera x 480).  
,, 3. A ventral chætæ from the posterior region. (Camera x 480).  
,, 4. A copulatory chætæ from the tenth segment. (Camera x 480).  
,, 5. The male apparatus of the right side, from a bisected specimen. *At.* atrium; *f.* sperm-funnel; *o.* the male pore; *p.* penis; *pr.* prostate; *sp.* sperm duct.  
,, 6. The spermatheca of the right side and the copulatory chætæ (*cop.*) in situ.

### *Branchiura pleurotheca*, Benham.

- ,, 7. A ventral chætæ. (Camera X 480).  
,, 8. The male apparatus (without the sperm duct), seen in longitudinal section, somewhat diagrammatically drawn. *At.* atrium, lined by tall glandular cells; *d.* duct, lined by cuticulated epithelium continuous with the epidermis; *m.* muscular coat; *n.* neck, lined by cubical cells; *o.* the male pore; *pr.* prostate cells; *sp.* sperm duct entering the atrium.  
,, 9. The spermatheca of the left side.  
,, 10. A transverse section of the body (camera outline x 80), showing on the right side the spermathecal pore, and on the left the chætæ, which occur in the neighbouring section. *D.* dorsal chætæ; *d.* muscular duct of the spermatheca; *int.* intestine, above it is the dorsal blood trunk, below it the ventral; *nc.* nerve cord; *spt.* spermatheca, the contained spermatozoa are omitted; *t.* testis; the coelom is filled with developing spermatozoa.  
,, 11. The bunch of copulatory chætæ from segment xi. with their muscles.  
,, 12. Integumental network of bloodvessels and its connection with the dorsal and ventral trunks through the parietal vessels (*pr.*); *Dv.* dorsal blood trunk; *Vr.* ventral blood trunk.

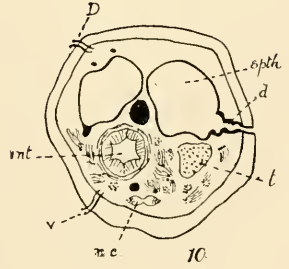
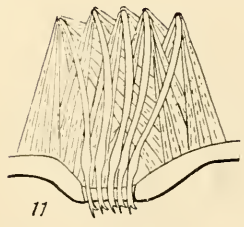
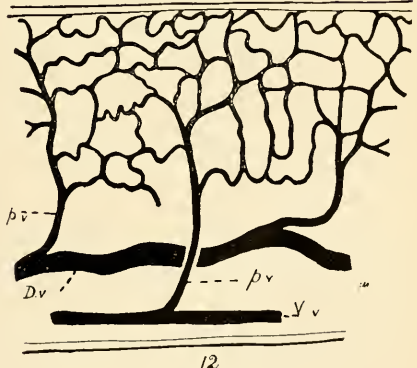
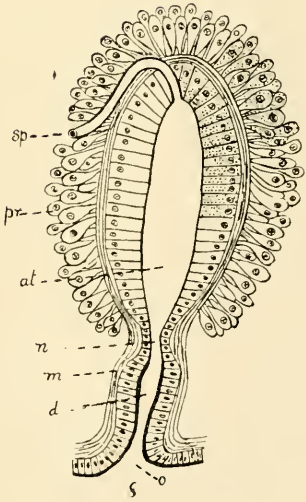
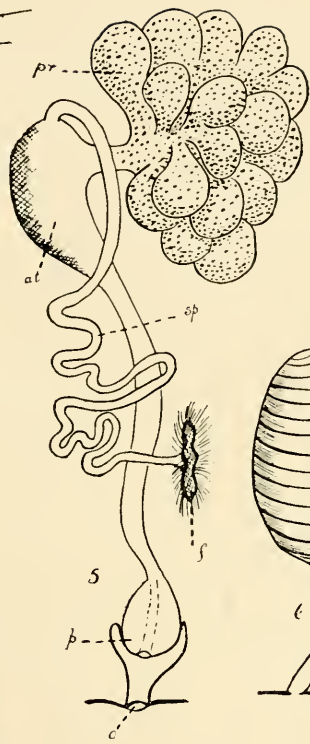
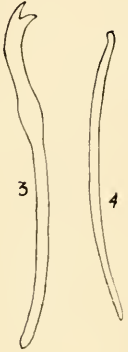





EXPLANATION OF PLATE XLVII.

*Phreodriloides notabilis*, Benham.

- „ 13. A ventral chata.
- „ 14. View of part of the male apparatus of the left side as seen in a stained specimen mounted entire; the sperm duct and funnel are omitted. *A.* the great muscular sac; *B.* the spherical, glandular sac, into which the sac *A.* opens on its mesial face; *m.* muscles; *o.* the male pore.
- „ 15. Diagrammatic reconstruction of the male apparatus, as seen in longitudinal section. *A.* the muscular sac; *B.* the glandular sac; *ce.* nucleus of coelomic epithelium; *cm.* circular muscles in wall of *A.*; *ep.* nucleus of epithelium lining *A.*; *f.* sperm funnel; *gl. ep.* glandular epithelium of *B.*; *m.* muscles around *B.*; *o.* male pore; *s.* septum xi./xii.; *sp.* sperm duct.
- „ 16. Obliquely transverse sections through the muscular sac (*A*) at the level of the entrance of the sperm duct. (Camera outline x 480, slide ii., row 2, sect. 2, right side). *c. ep.* nucleus of coelomic epithelium; *cm* circular muscle fibres; *ep.* nucleus of epithelium lining the muscular sac *A*; *ep'.* two cells bounding the entrance of the sperm duct into the muscular sac; *sp.* spermatozoa filling the muscular sac; *spd*, the sperm duct in section.
- „ 17. Obliquely longitudinal section through the glandular sac (*B*), near the entrance into it of the muscular sac (*A*). (Camera outline x 480, slide ii., row 2, section 15, right side). On this side of the body the lower end of the muscular sac, filled with spermatozoa, pushes the lining epithelium of the glandular sac outwards, and the communication between the two is found a few sections further on, at the level *x.* of the figure; *ep.* epidermis and epithelium of non-glandular portion of the glandular sac; *gl. ep.* glandular epithelium; *m.* muscles; *nc.* portion of nerve cord; *o.* male pore.



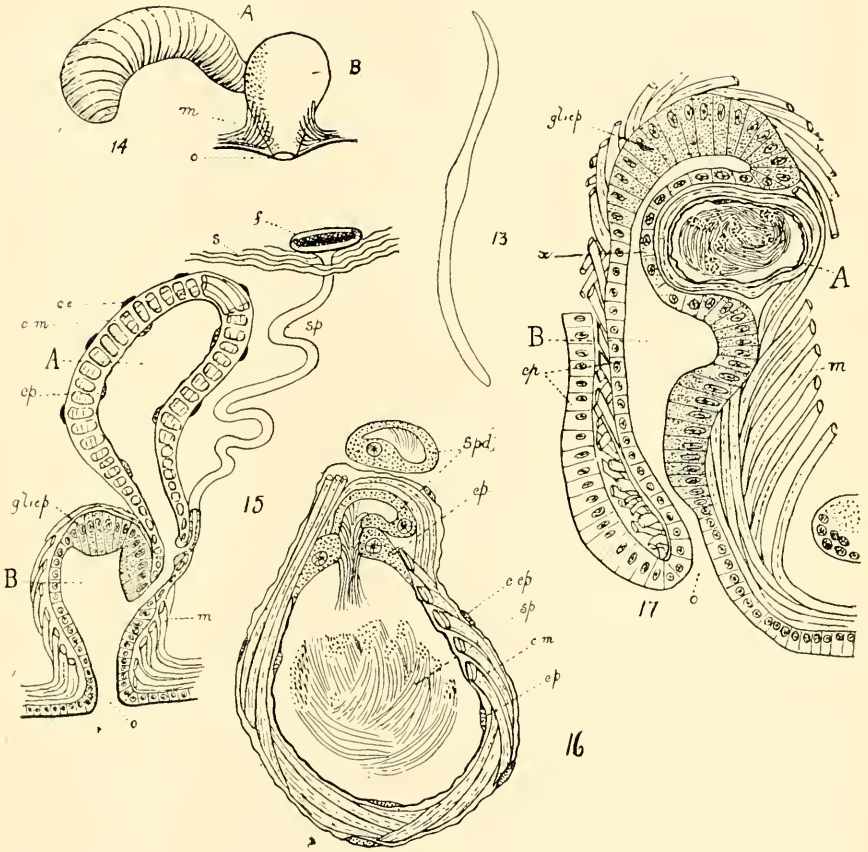





## EXPLANATION OF PLATE XLVIII.

---

### ORTHOCLASE.

In this and succeeding plates segments in twin position are lettered to correspond with a normally placed crystal turned through  $180^\circ$ .

Fig. 1. Adularia habit. Cockburn Creek, near Tamworth.

„ 2. Baveno doublet. Oban.

„ 3. Baveno triplet or (as lettered) combined Baveno and Manebach twin. Oban.

„ 4. Carlsbad twin. Oban.

„ 5. Manebach twin. Bolivia.

„ 6. Carlsbad twin. Inverell.

Forms:— $c$  (001),  $a$  (100),  $b$  (010),  $m$  (110),  $l$  (130),  $x$  ( $\bar{1}01$ ),  $y$  ( $\bar{2}01$ ),  $n$  (021),  $o$  ( $\bar{1}11$ ).

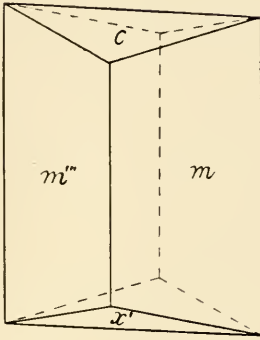

1

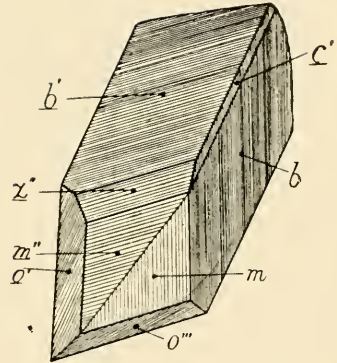

2

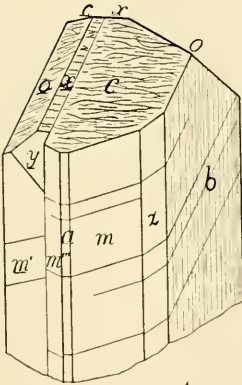

3

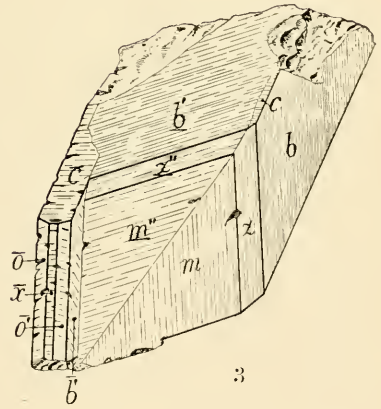

4

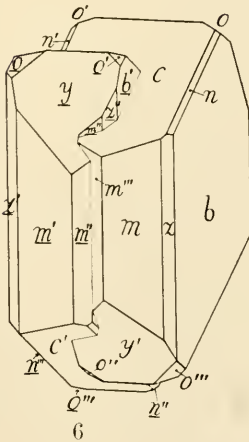

5

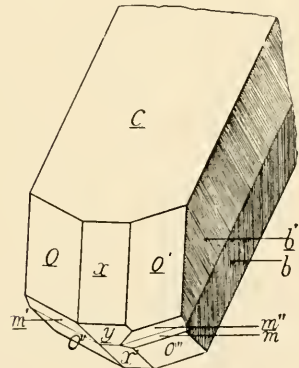

6





## EXPLANATION OF PLATE XLIX.

---

### ORTHOCLASE.

- Fig. 1. Baveno twin. Oban.
- Fig. 2. Baveno triplet or combined Baveno and Manebach twin. Oban (?).
- Figs. 1 and 2, which are about four times natural size, are bounded by the faces *c* and *b*, which are placed perpendicular to the plane of the paper.
- Fig. 3. Group of orthoclase and quartz crystals, about twice natural size; the largest Carlsbad twin consists of the forms *c*, *b*, *m*, *x*, *o*; the Manebach twin is separately drawn in Pl. *xlvi*ii., fig. 5. Bolivia.
- Fig. 4. Right-handed Carlsbad twin; about twice natural size. Bolivia.
- Fig. 5. Left-handed Carlsbad twin; about four times natural size. Uralla.
- Figs. 4 and 5 have the forms *c*, *b*, *m*, *x*, *y*, *o*.

(For indices see Explanation to Plate *xlvi*ii).



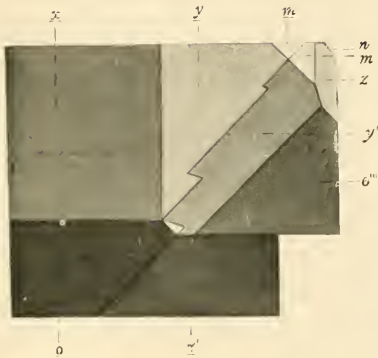

1

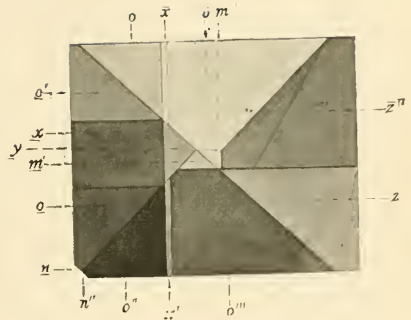

2

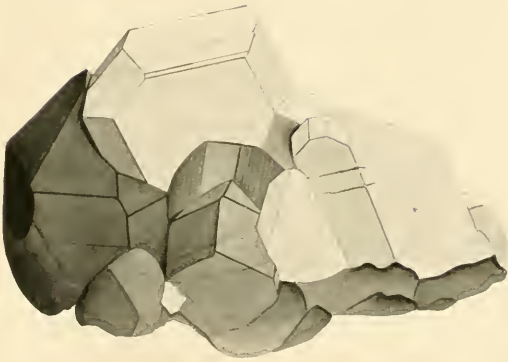

3

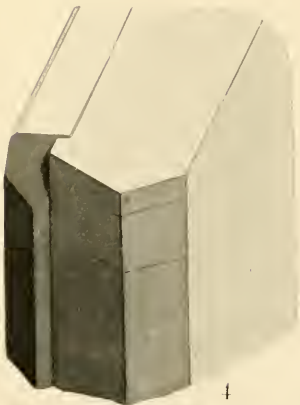

4

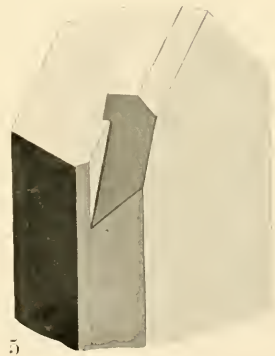

5





EXPLANATION OF PLATE L.

---

ORTHOCLASE.

- Fig. 1. Two "partial" crystals with  $c$ ,  $b$ ,  $m$ ,  $x$ ,  $y$ , penetrated by quartz with principal axes parallel to one direction; slightly enlarged. Oban.
- Fig. 2. Baveno group; natural size. Oban.



1



2





EXPLANATION OF PLATE LI.

---

ORTHOCLASE.

Crystal of smoky quartz penetrated by Baveno twin; natural size. Oban.





H BARNES, Junr., photo.  
Austr. Mus.





EXPLANATION OF PLATE LII.

---

ORTHOCLASE.

Decomposed crystals carrying pericline twins of albite ; natural size.  
Oban.







EXPLANATION OF PLATE LIII.

---

Lettering—*g*, granules ; *n*, nuclei ; *o*, oil-globules ; *s*, spicules ;  
*x*, Xanthellæ.

- Fig. 1. *Collozoum armatum*, Haswell. A single zooid in optical section. x 450.
- Fig. 2. *Collozoum alpha*. A portion of the colony shewing one of the ordinary zooids and one of the masses of granule-like bodies supposed to be microspores. x 450.
- Fig. 3. *Collozoum ovale*, Haswell. A single zooid. x 300.
- Fig. 4. *Collozoum arcuatum*, Haswell. A single zooid with the peculiarly modified Xanthellæ. The oil-globule has been here rendered black. The amorphous pigmented masses within the capsule are not represented. x 450.
- Figs. 4A, 4B, 4C. Xanthellæ of *Collozoum arcuatum*. x 900.
- Fig. 5. *Collozoum beta*. A single zooid in optical section, showing the layer of minute bodies superficial to the capsular-membrane. x 300.
- Fig. 6. *Collosphæra hedleyi*, Haswell. Test of a zooid. x 300.
- Fig. 7. *Collosphæra unifornis*, Haswell. Test. x 300.



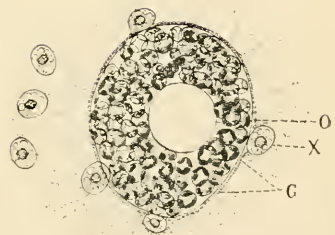
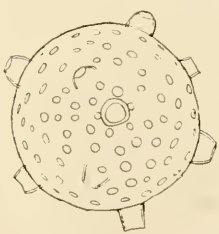
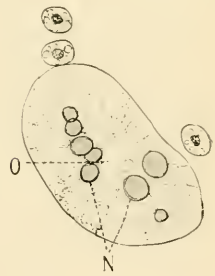
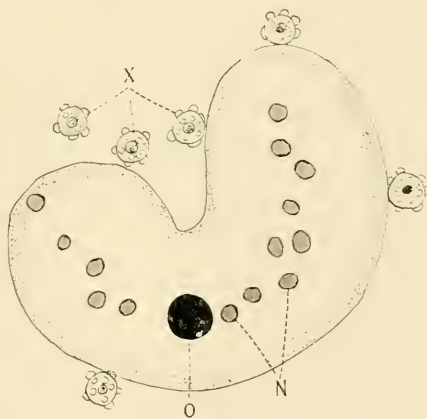
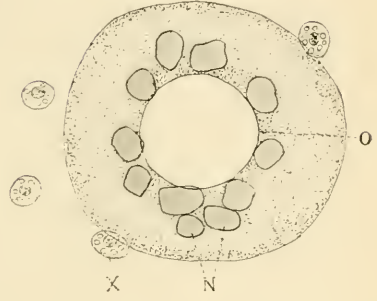
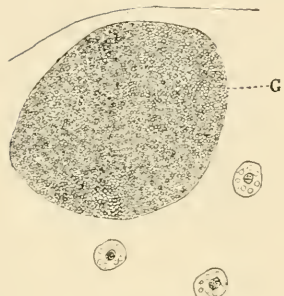
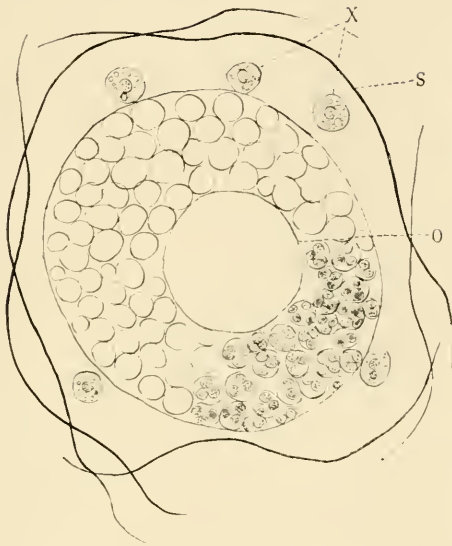



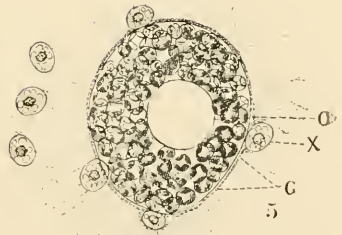
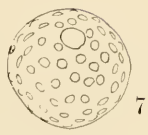
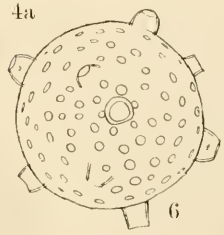
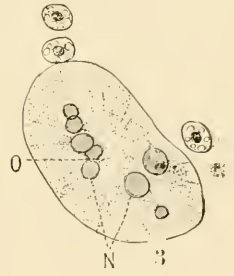
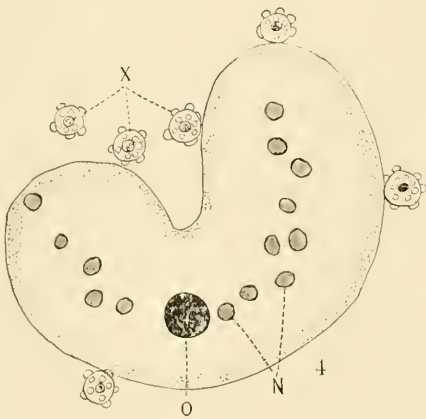
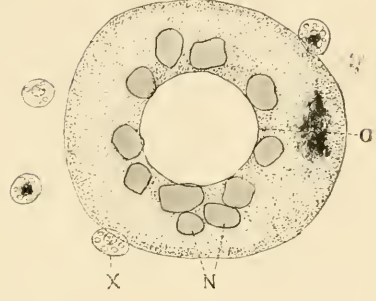
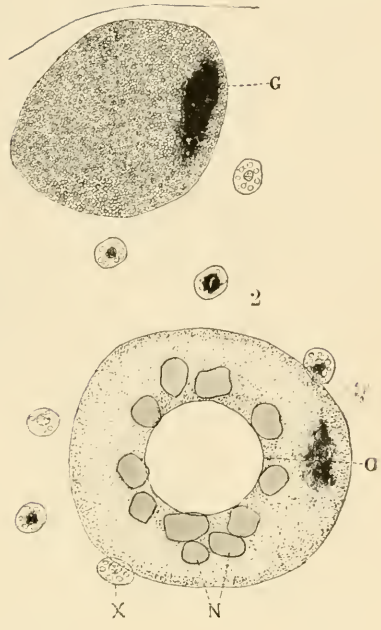
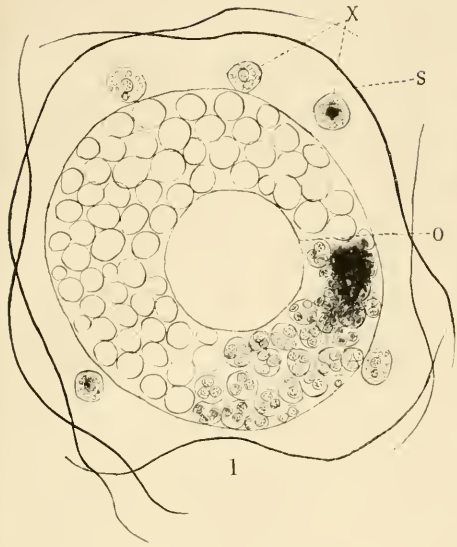





EXPLANANATION OF PLATE LIV.

---

- Fig. 1. *Cocculina coërcita*, Hedley. From the side.  
 " 2. " " " " From above  
 " 3. *Puncturilla demissa*, Hedley. From the side.  
 " 4. " " " " From above.  
 " 5. " " " " Sculpture, magnified.  
 " 6. *Crossea naticoides*, Hedley. From the side.  
 " 7. " " " " From beneath.  
 " 8. *Vermicularia nodosa*, Hedley.  
 " 9. *Turritella opulenta*, Hedley.  
 " 10. *Admete stricta*, Hedley.  
 " 11. *Mangelia lutaria*, Hedley.  
 " 12. " " " " Apex, from above.  
 " 13. *Cavolina longirostris* var *strangulata*, Hedley.

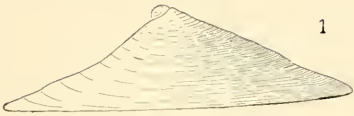

1



2

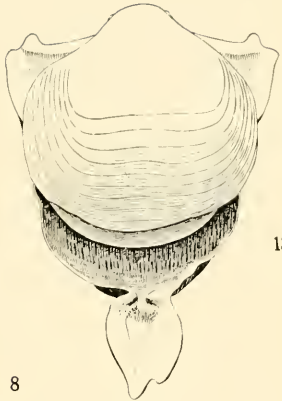

13



12

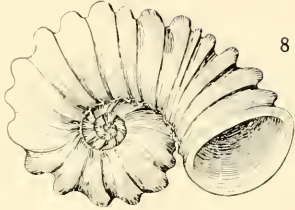

8

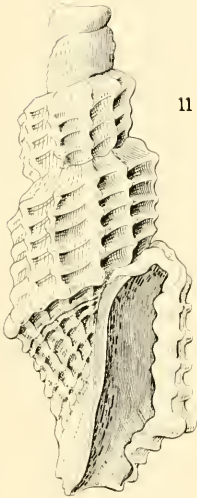

11



3



5

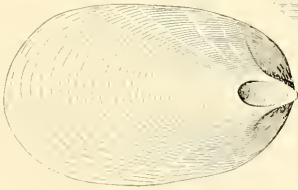

4

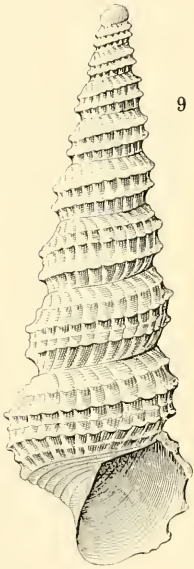

9

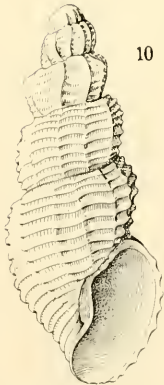

10

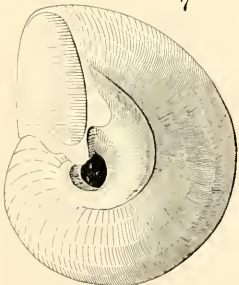

7

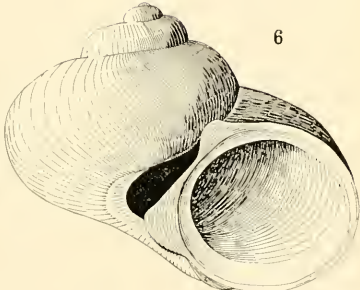

6







EXPLANATION OF PLATE LV.

---

- Fig. 14. *Eulima fricata*, Hedley.  
" 15. *Aspella undata*, Hedley.  
" 16. *Cithna angulata*, Hedley.  
" 17. *Trivia avellanoides*, M'Coy. From above.  
" 18. " " " From beneath.  
" 19. *Trophon stimuleus*, Hedley.  
" 20. *Mangelia spica*, Hedley.  
" 21. *Pleurotomella fastosa*, Hedley.  
" 22. *Drillia haswelli*, Hedley.

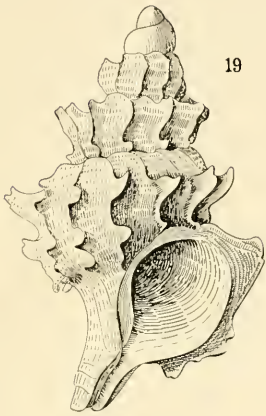

19

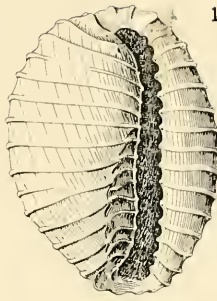

18

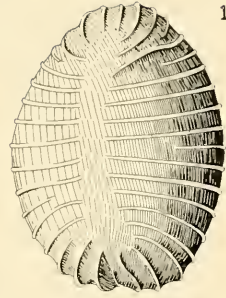

17

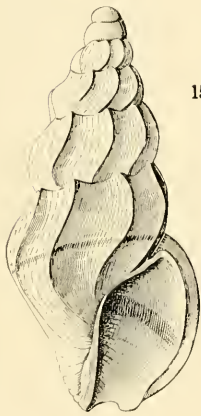

15



14

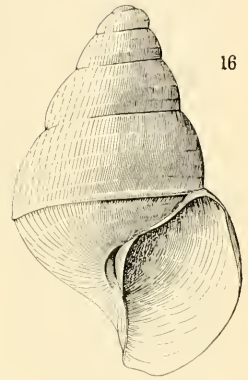

16

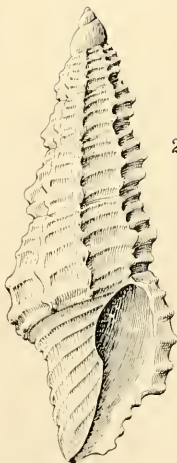

20

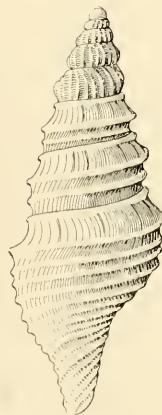

21

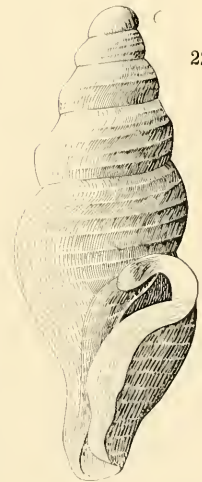

22





EXPLANATION OF PLATE LVI.

---

- Fig. 23. *Modiola linea*, Hedley. From without.  
 " 24. " " " " From above.  
 " 25. " " " " From within.  
 " 26. *Crassatellites discus*, Hedley. From above.  
 " 27. " " " " From the side.  
 " 28. *Coriareus vitreus*, Hedley. From the side.  
 " 29, 30. " " " " Hinge.  
 " 31. *Lyonsiella quadrata*, Hedley. From the side.  
 " 32. " " " " From above.  
 " 33. " " " " From within.  
 " 34. *Verticordia vadosa*, Hedley. From the side.  
 " 35. " " " " From above.  
 " 36, 37. " " " " Hinge.  
 " 38. " " *australiensis*, Smith. From above.  
 " 39. " " " " From within.



30

29

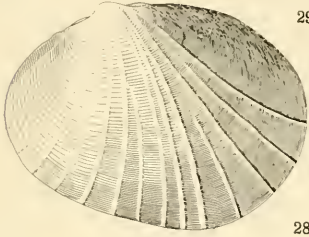

28

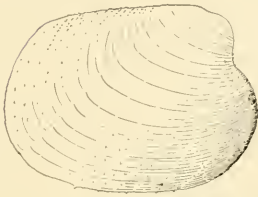

31



32



33

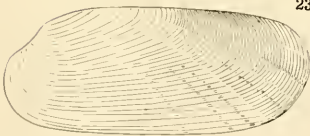

23



24



25



39



38



37



36



35

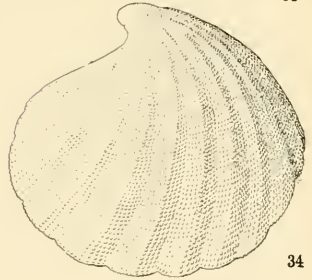

34



26

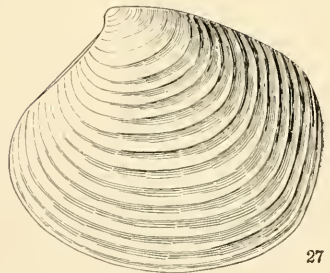

27







EXPLANATION OF PLATE LVII.

---

Slab of calcareous shale covered with *Spirulæa gregaria*, Eth. fil.

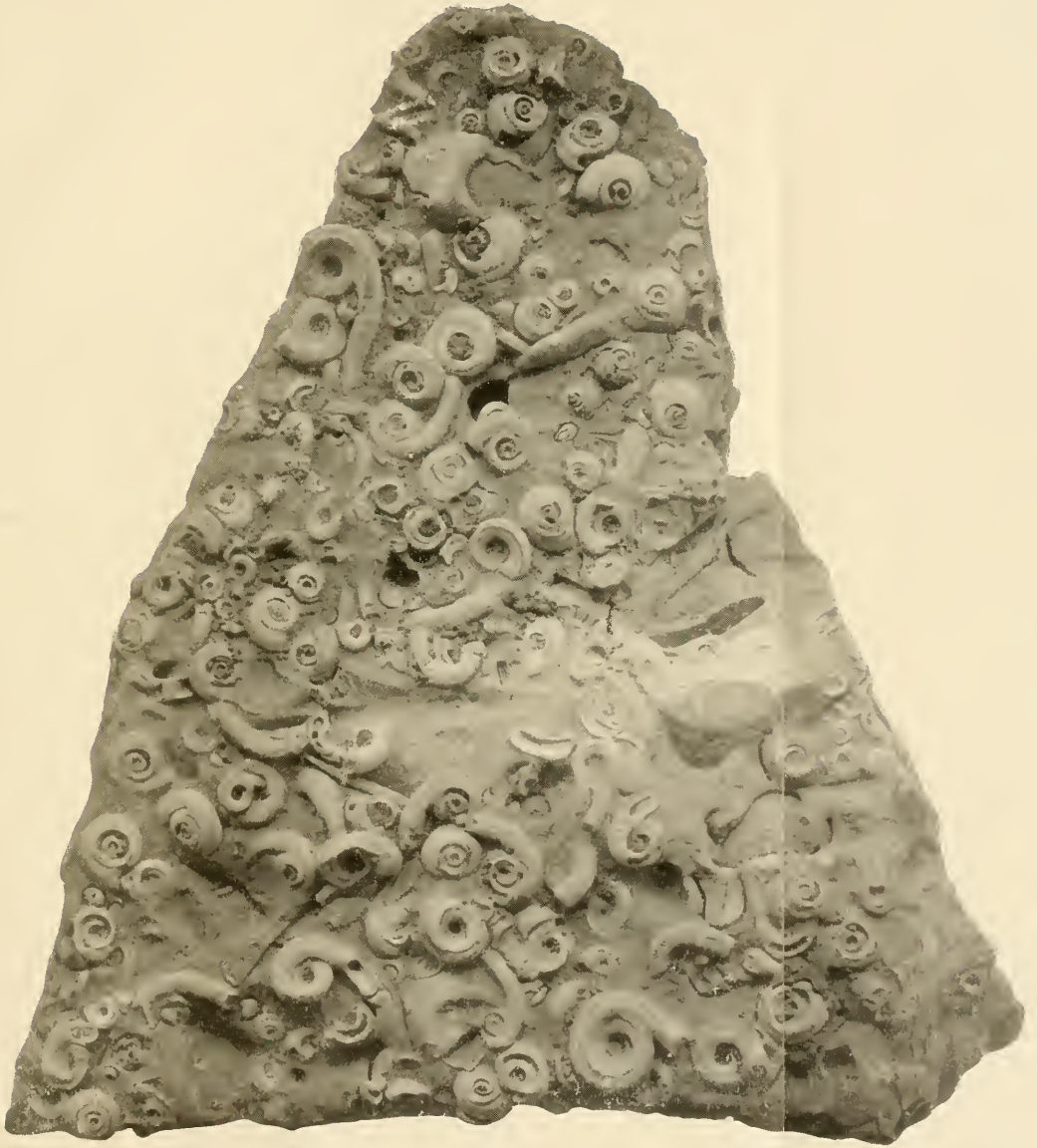



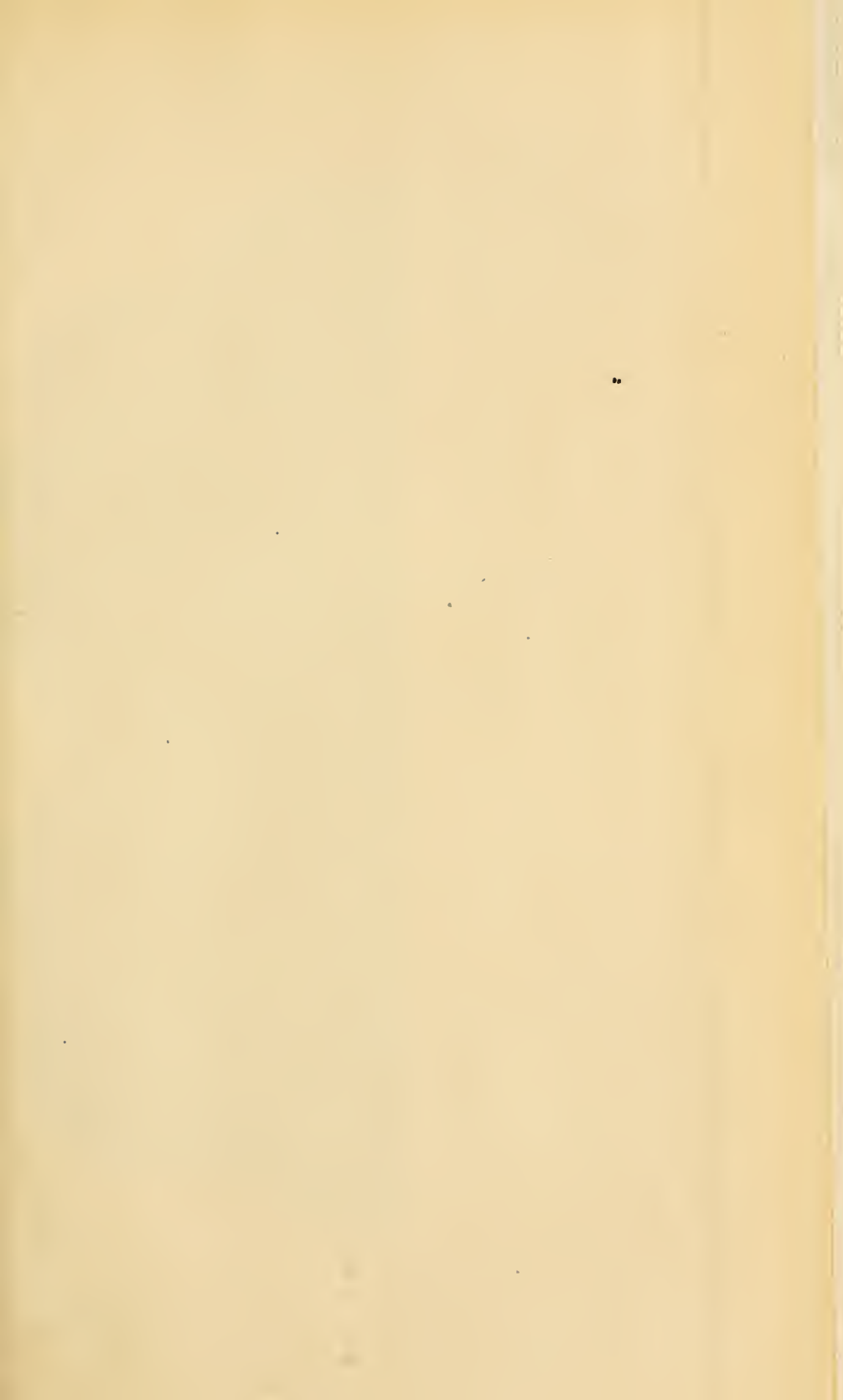

EXPLANATION OF PLATE LVIII.

Group of *Aucella hughendenensis*, Eth.



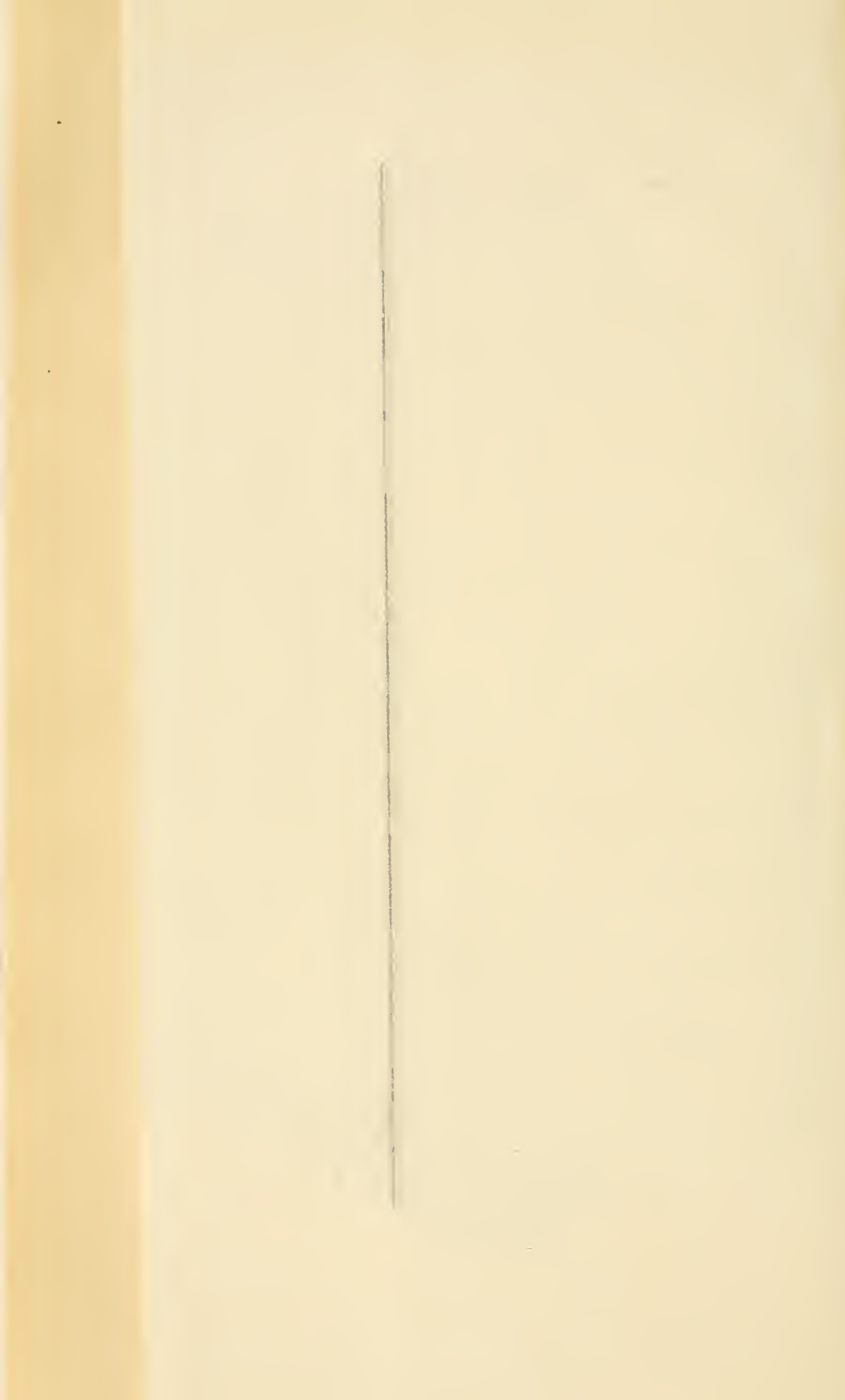





EXPLANATION OF PLATE LIX.

---

Slab of Pachydomella calcareous shale exhibiting the profusion in which *Pachydomella chutus*, Eth. fil., occurs.

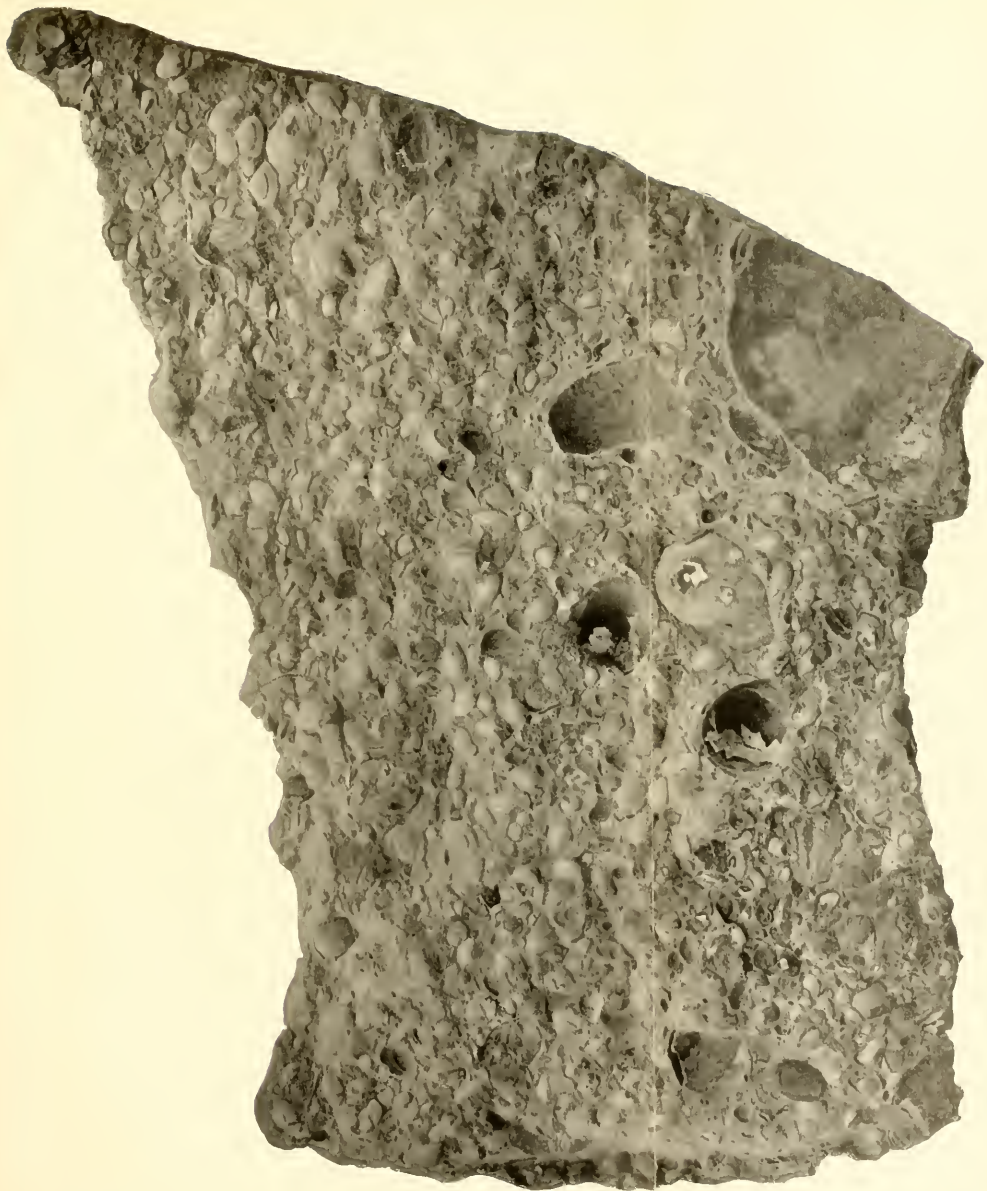





EXPLANATION OF PLATE LX.

SPIRULEA CRETACEA, *Eth. fil.*

- Fig. 1. Two tubes in contiguity, one extended— $\times 2$ .  
,, 2. Another example, concave aspect— $\times 2$ .  
,, 3. A third specimen, concave aspect, with the free tube fractured, and a telescopic umbilicus— $\times 2$ .

COPROLITES.

- ,, 4. Fusiform body with a more or less spiral end.  
,, 5. Another example with the termination more acute.

MODIOLA DUNLOPENSIS, *Eth. fil.*

- ,, 6. Rather more than the posterior third of the conjoined valves.

GRAMMATODON (?) DAINTREEI, *Eth. fil.*

- ,, 7. The two valves, one testaceous, the other an internal cast— $\times 3$ .  
,, 8. Interior of the valve removed from the cast in Fig 7— $\times 3$ .

TRIGONIA CINCTUTA, *Eth. fil.*

- ,, 9. Cast of portion of the exterior of a right valve taken from an impression in calcareous shale.

ODONOSTOMIA (?) CRETACEA, *Eth. fil.*

- ,, 10. Three whorls and a heterostrophic apex; the delicate decussate sculpture on the body whorl is faintly visible— $\times 4$ .  
,, 10a. The heterostrophic apex, much enlarged.

CANCELLARIA (?) TERRAREGINENSIS, *Eth. fil.*

- ,, 11. Four whorls, the body whorl with transverse keels and costæ— $\times 5$ .



6.

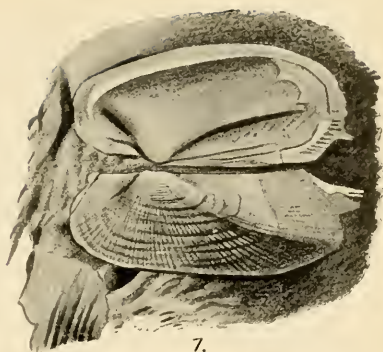

7.

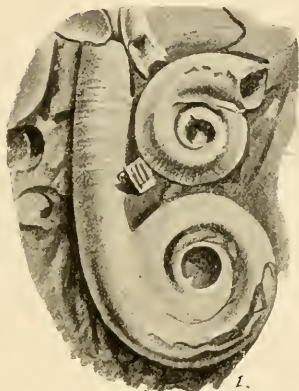

1.



10.



2.



11.

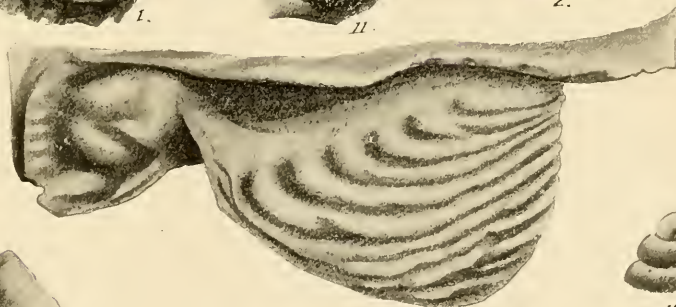

9.



10<sup>a</sup>

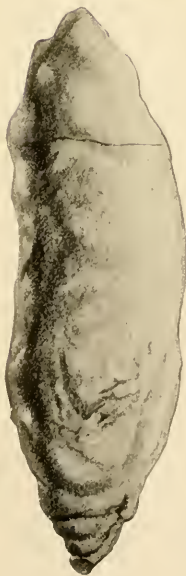

4.



3.

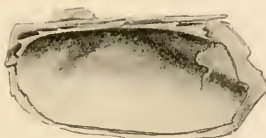

8.



5.







EXPLANATION OF PLATE LXI.

---

MACCOYELLA CORBIENSIS, *Moore, sp. (?)*.

- Fig. 1. Articulus of the left valve.  
" 2. Portion of a left valve with posterior auricle.  
" 3. Left valve, one of the largest specimens, with costae.  
" 4. A similar left valve.  
" 5. A much broader example of a left valve, with posterior alation approaching *Oxytoma rockwoodensis*, Eth. fil., in outline.  
" 6. Longitudinally elongated individual with well preserved sculpture.

AUCELLA HUGHENDENENSIS, *Etheridge*.

- " 7. Portion of the united valves. The auricle of the right valve and the anterior dorsal margin of the latter are seen to be crenulated— $\times 2$ .  
" 8. Left valve of a typical specimen.  
" 9. Group of young individuals on the weathered surface of a piece of impure limestone.  
" 10. The valves in apposition showing the auricle of the right valve received in an anterior inflection of the cardinal margin— $\times 2$ .  
" 11. Portion of valves in apposition but exhibiting the area of the left valve— $\times 3$ .  
" 12. The specimen of which Fig. 11 is a partial enlargement— $\times 2$ .

ANISOMYON (?) DEPRESSUS, *Eth. fil.*

- " 13. Lateral view.  
" 14. Apical view.

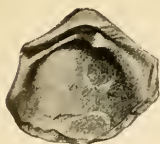

1.

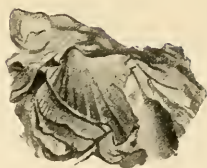

2.



3.

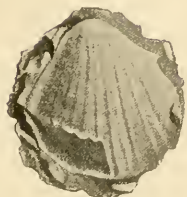

4.

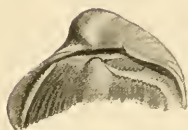

7.



13.



14.

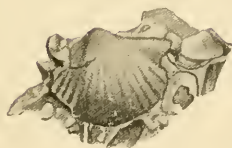

5.

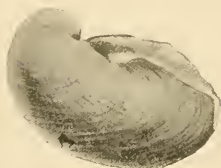

8.



9.



6.

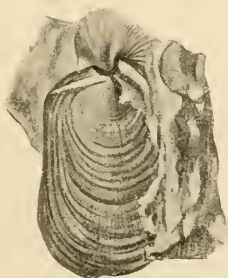

12.



11.



10.





EXPLANATION OF PLATE LXII.

---

CYTHEREA (?) MOOREI, *Eth. fil.*

- Fig 1. A left valve— $\times 2$ .  
" 2. Portion of the anterior end of another specimen exhibiting the lunule— $\times 3$ .  
" 3. A right valve with an epiostracum and characteristic sculpture— $\times 2$ .

PACHYDOMELLA CHUTUS, *Eth. fil.*

- " 4. A left valve, a characteristic specimen— $\times 3$ .  
" 5. Another left valve with well marked epiostracum— $\times 3$ .  
" 6. A similar specimen to Fig. 5— $\times 3$ .  
" 7. An internal cast of the valves in apposition— $\times 3$ .  
" 8. A testaceous example with the valves in apposition— $\times 3$ .

VANIKOROPSIS (?) STUARTI, *Eth. fil.*

- " 9. A specimen with a limited number of oblique costæ, the intersection of the latter and the spiral lines nodose— $\times 2$ .  
" 10. An example in which the sculpture is very regular, but the depressions caused by the wearing off of the nodes commencing to show below the suture on the body-whorl— $\times 3$ .  
" 11. Portion of the characteristic sculpture highly magnified.  
" 12. A specimen resembling Fig. 10— $\times 2$ .  
" 13. Portion of the mouth, imperfect— $\times 2$ .



1.



2.

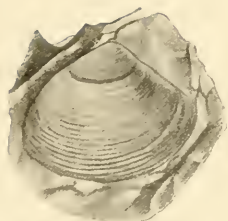

3.



10.



9.

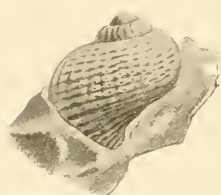

12.

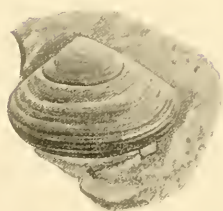

4.



13.

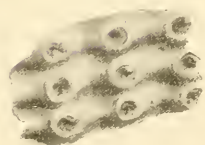

11.

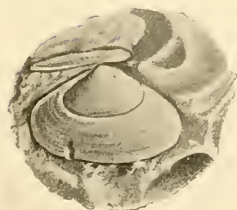

5.



7.



8.

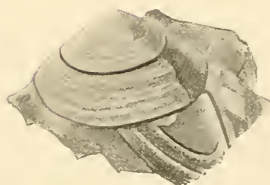

6.







EXPLANATION OF PLATE LXIII.

---

- Fig. 1. *Macrounus nigromaculatus*, sp. nov.  
  , 1a.       "       "       "       top view of head.  
  " 2. *Cælorhynchus innotabilis*, sp. nov.  
  " 2a.       "       "       "       top view of head.  
      (All the figures are of the natural size).

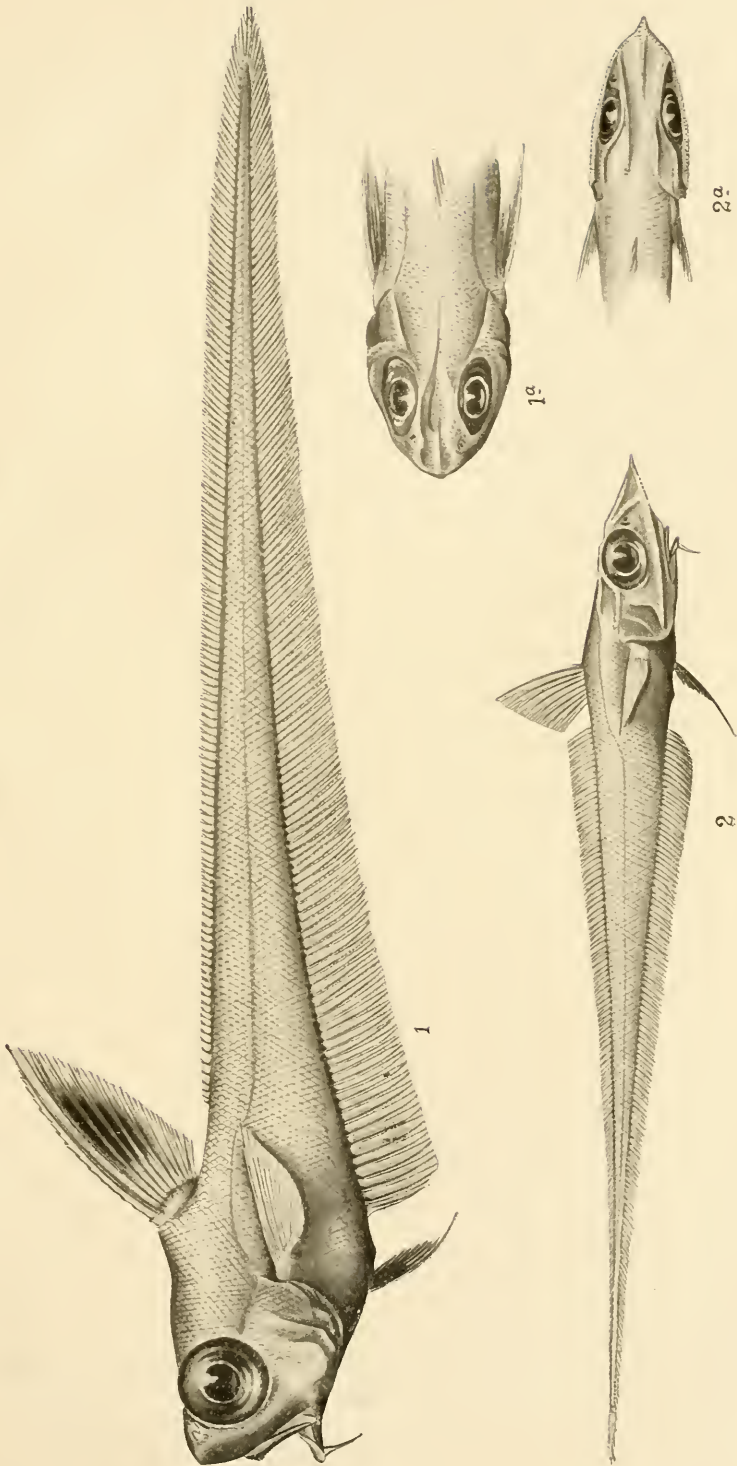





EXPLANATION OF PLATE LXIV.

---

*Hoplichthys haswelli*, sp. nov.

(Reduced).

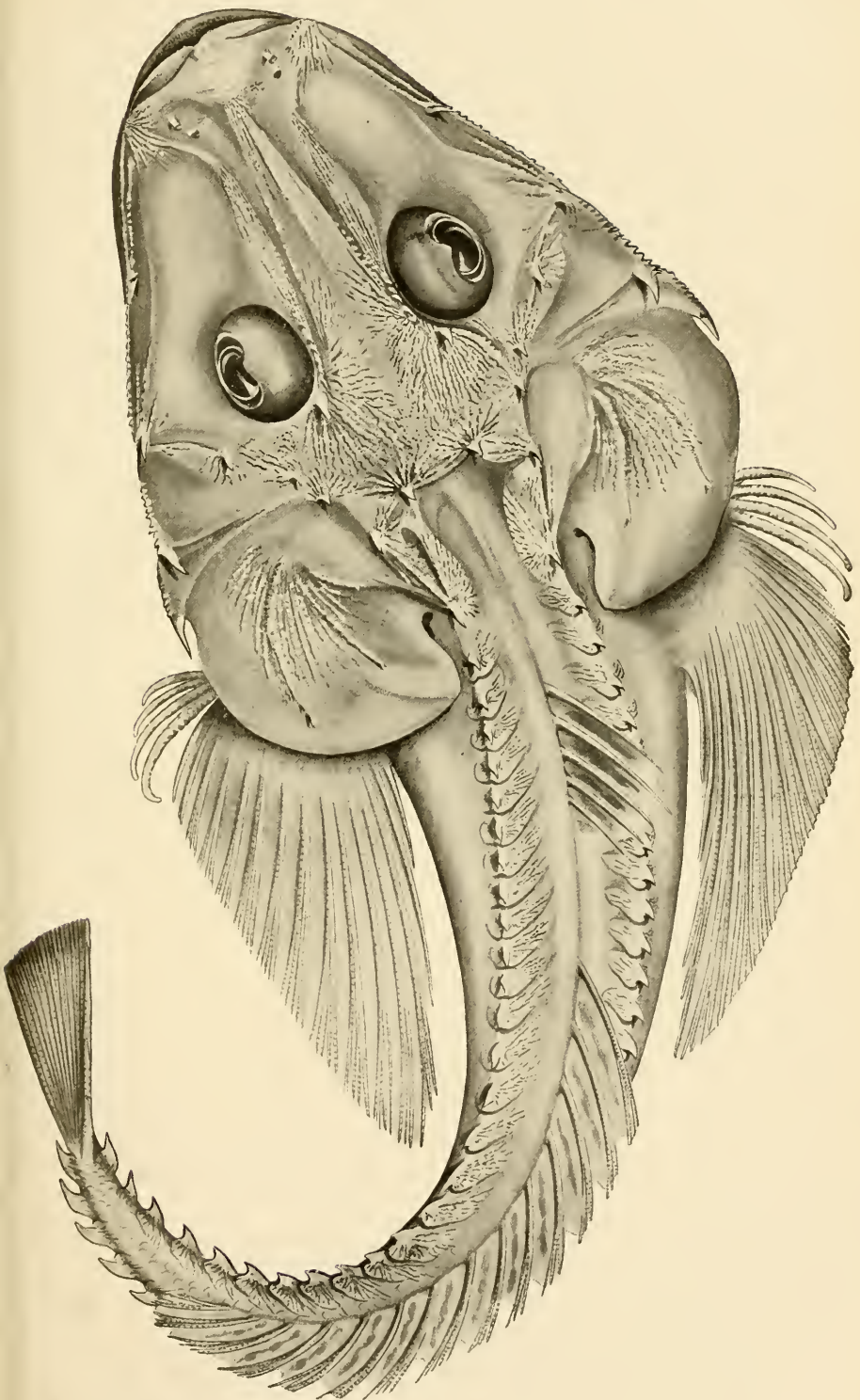







EXPLANATION OF PLATE LXV.

---

*Latreilopsis petterdi*, Grant.

(Reduced).

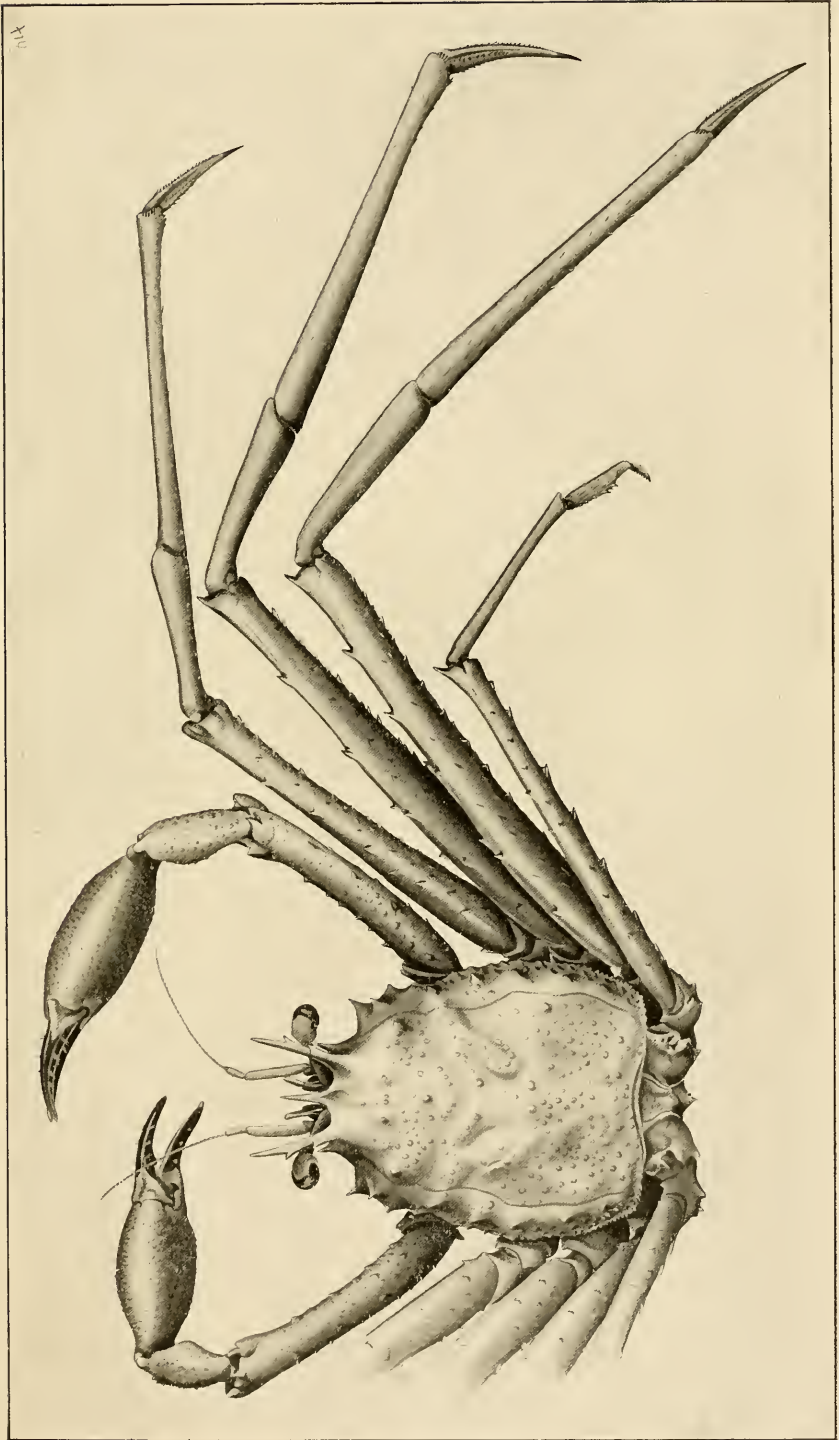





EXPLANATION OF PLATE LXVI.

---

- Fig. 1. *Leda pala*, Hedley.  
.. 2, 3. *Leda fortis*, Hedley—hinge and exterior.  
.. 4, 5. *Thyasira albigena*, Hedley—hinge and exterior.  
.. 6. *Cuspidaria alveata*, Hedley.  
.. 7, 8, 9, 10. *Turquetia integra*, Hedley—hinge, profile, exterior and interior.  
.. 11, 12. *Lucina induta*, Hedley—hinge and exterior.

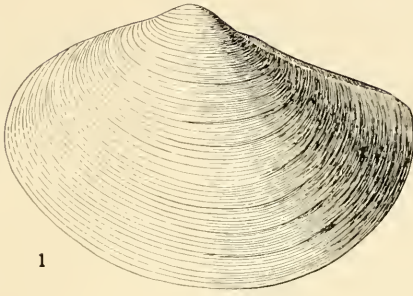

1

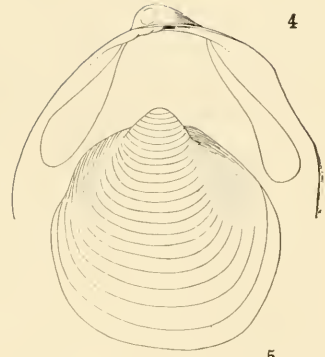

4

5

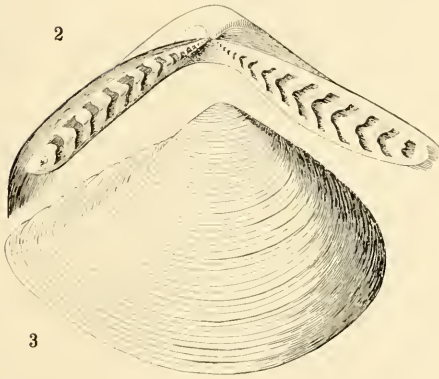

2

3

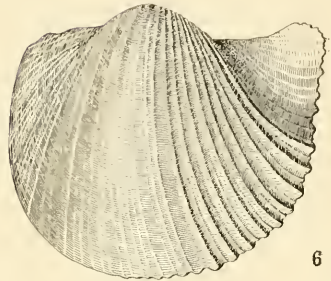

6

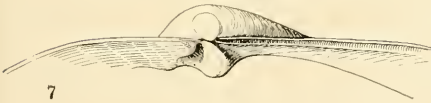

7



8



11

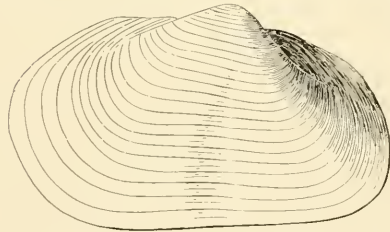

9

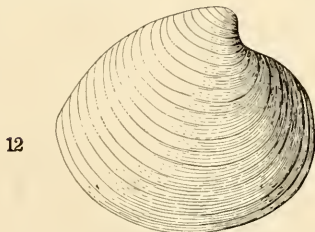

12

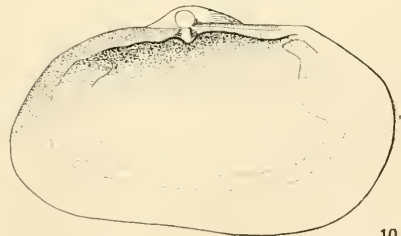

10







EXPLANATION OF PLATE LXVII.

---

- Fig. 13, 14. *Liotia capitata*, Hedley.  
,, 15. *Rissoa profundior*, Hedley.  
,, 16. *Pyrene babylonica*, Hedley.  
,, 17. *Philine oscitans*, Hedley.  
,, 18. *Epitonium bellicosum*, Hedley.  
,, 19. *Turritella curialis*, Hedley.  
,, 20. Immature example of *Tiberia nitidula*, A. Adams, inadvertently included in this plate.  
,, 21. *Arcularia dipsacoides*, Hedley.

13

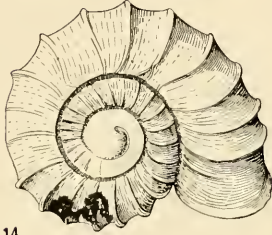

14

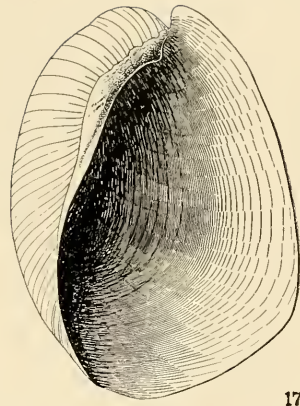

17

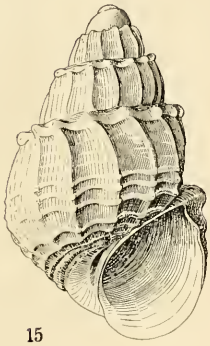

15



18

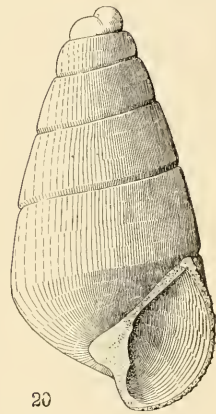

20

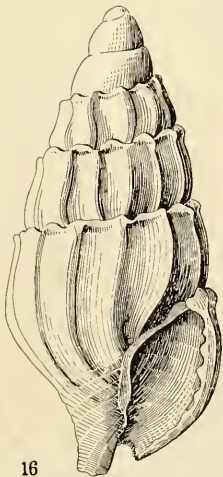

16



19

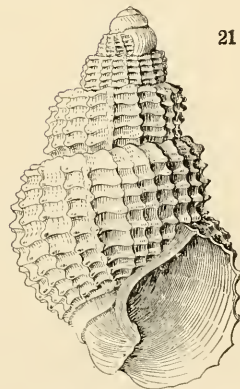

21





EXPLANATION OF PLATE LXVIII.

---

- Fig. 1. Corpse with the head enveloped in a dilly bag, slung on a pole supported by two forked uprights—Margaret Bay, Cape York Peninsula.
- „ 2. Mourner wrapt up in fishing nets belonging to his deceased father for whom he mourns. Melvor River, North of Cape Bedford.

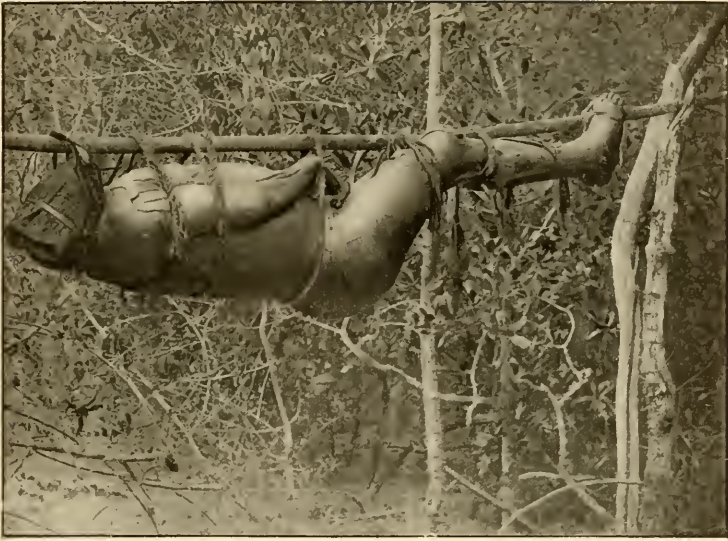

1



2

G. PYM, photo. (fig. 1).  
W. E. ROTH, photo. (fig. 2).

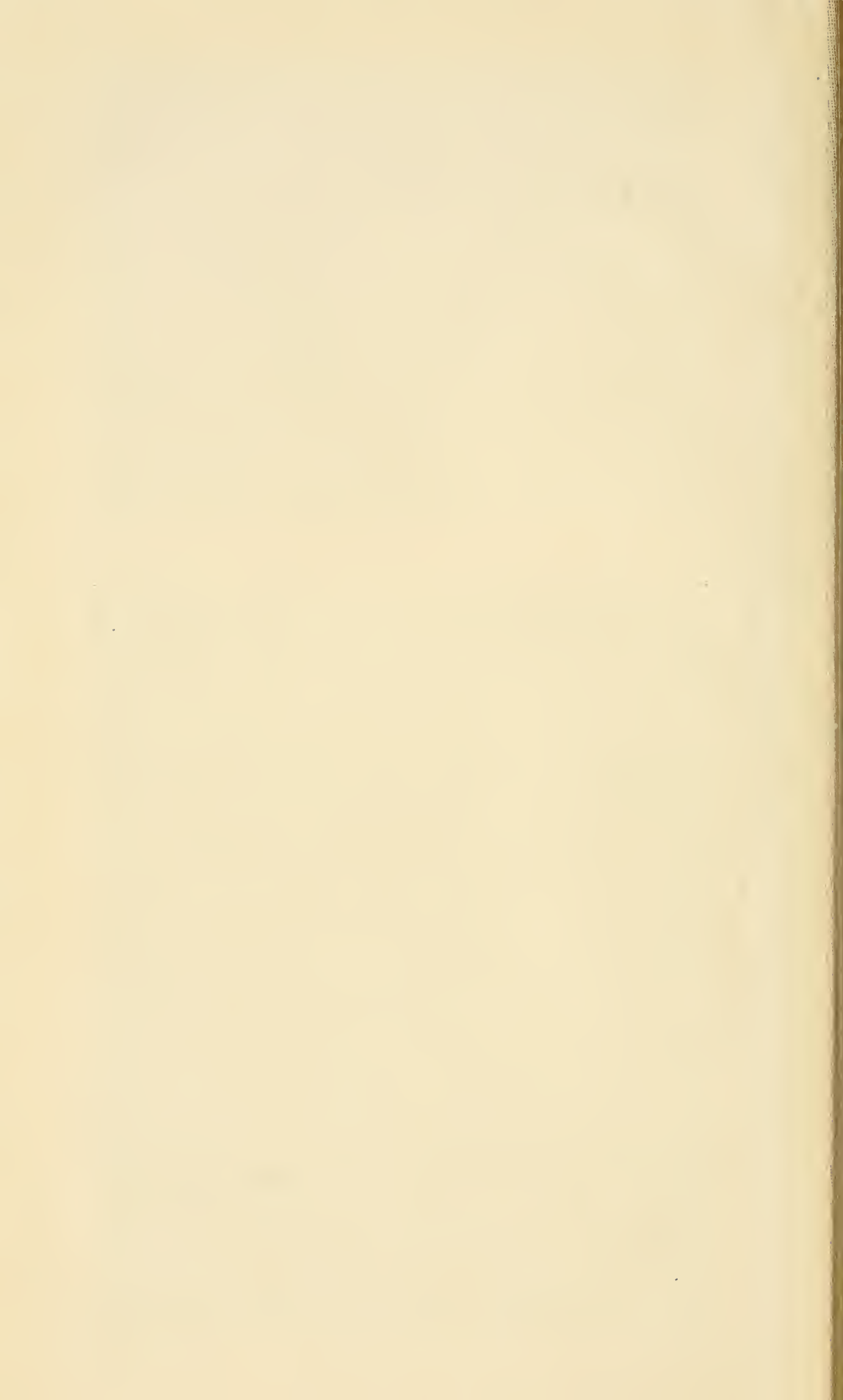









## EXPLANATION OF PLATE LXIX.

---

- Fig. 1. Decorated fibula—pau-to or pau-uto—carried about slung either from around the forehead so as to hang over the nape of the neck, or else over the forearm, by the near relatives of a deceased person. The ends of the bone are encased in gum-cement and the latter wrapped with bark-string and *Dendrobium* lashing; the shaft is encased in a wrapping of Emu feathers bound with bark-string. Nggerikudi Tribe, Pennefather and Batavia Rivers, Cape York Peninsula.
- ” 2. Another example of the same, the extremities of the bone not encased in gum-cement and the Emu feather wrapping secured with human hair-string; the suspending string is a piece of fabric.

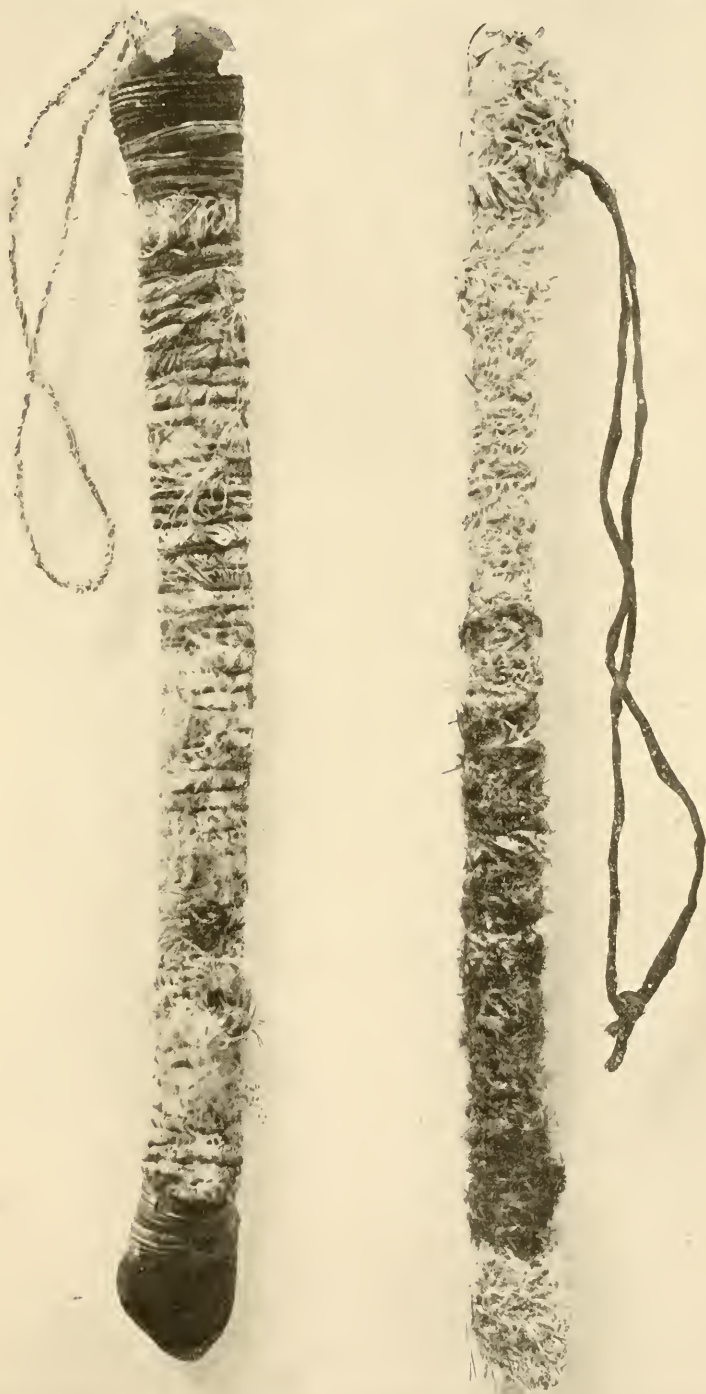

1

2

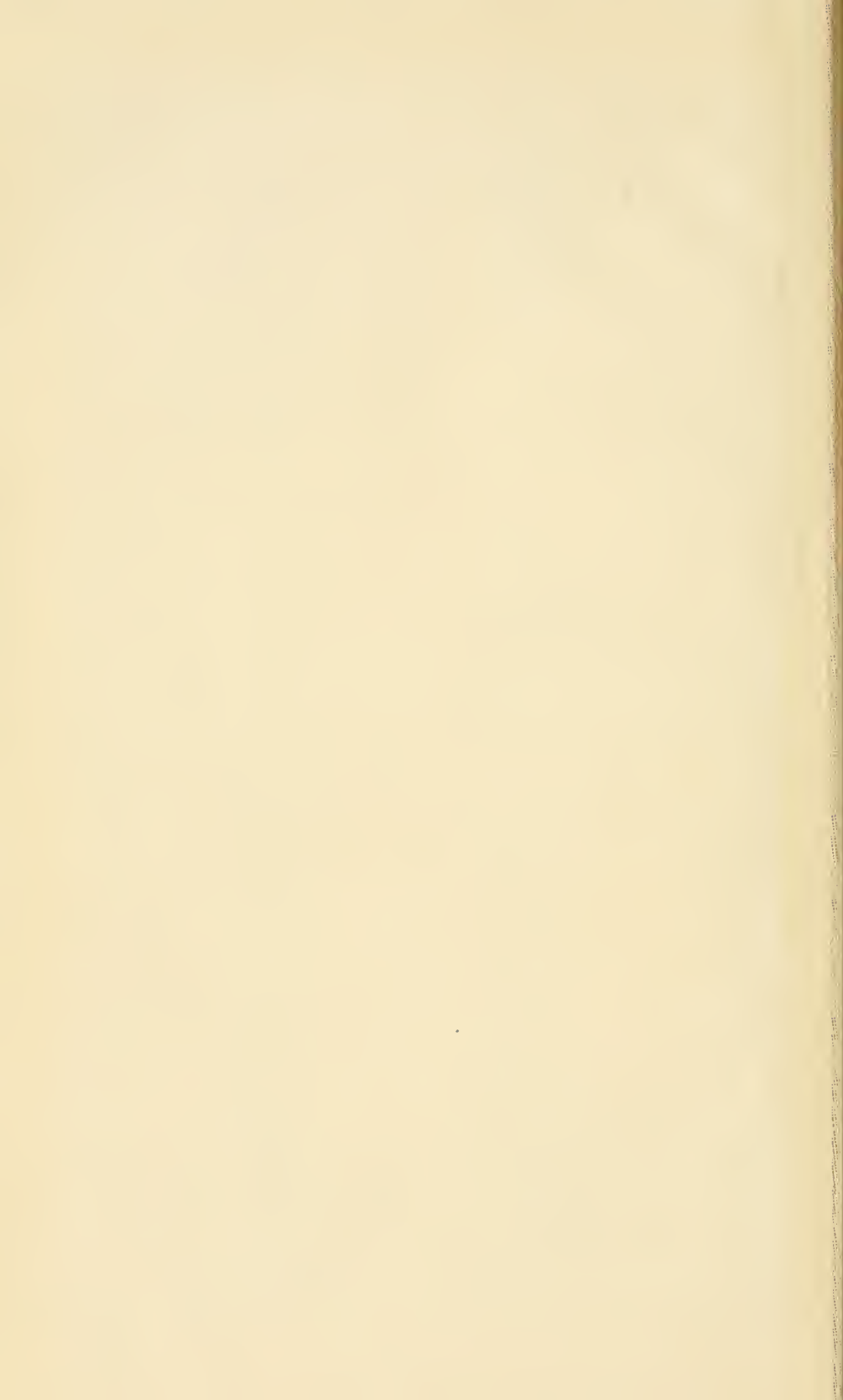



#### EXPLANATION OF PLATE LXX.

---

Figs 1 and 2. Ornaments said to contain portions of a deceased person's flesh worn by the avenging relatives in similar positions to the pau-to (Plate lxix.). These are composed outwardly of a mass of gum-cement covered in the upper position with soft yellow fur (? *Phalanger*), and below studded with *Abrus precatorius* seeds. They are the lin-ji-ila of the Middle Palmer River natives.



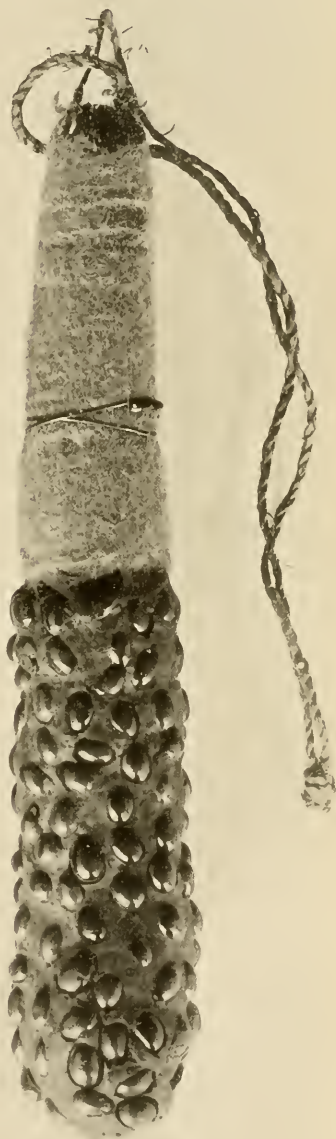

1

H. BARNES, Junr., photo.,  
Austr. Mus.

2

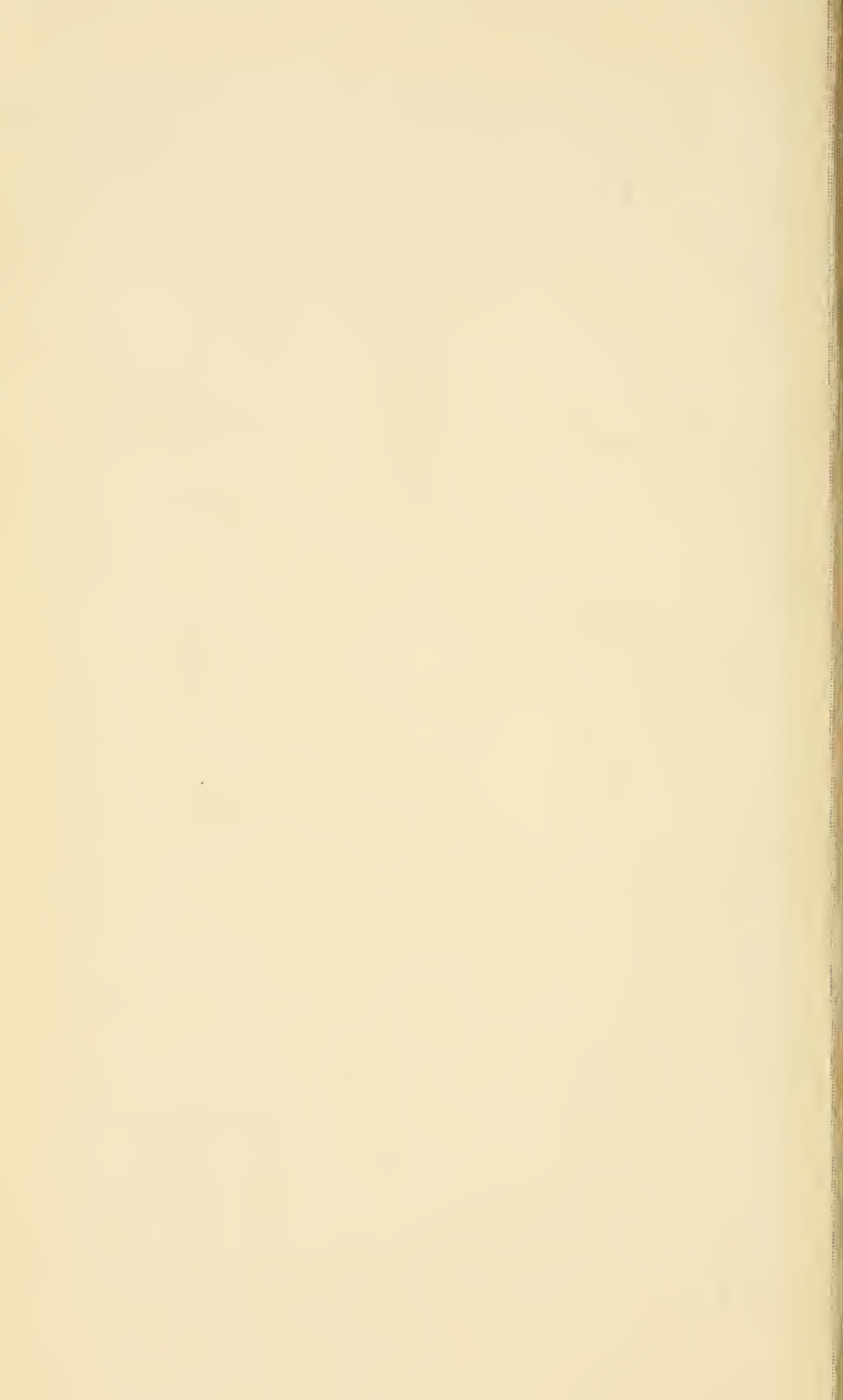



EXPLANATION OF PLATE LXXI.

---

Figs. 1—3. Stages in dessication on the Russell River Goldfield, Cairns District.

1



2.



3.







EXPLANATION OF PLATE LXXII.

---

Figs. 1—3. Stages in dessication on the Rosewell River Goldfield, Cairns District.



1.



2.



3.



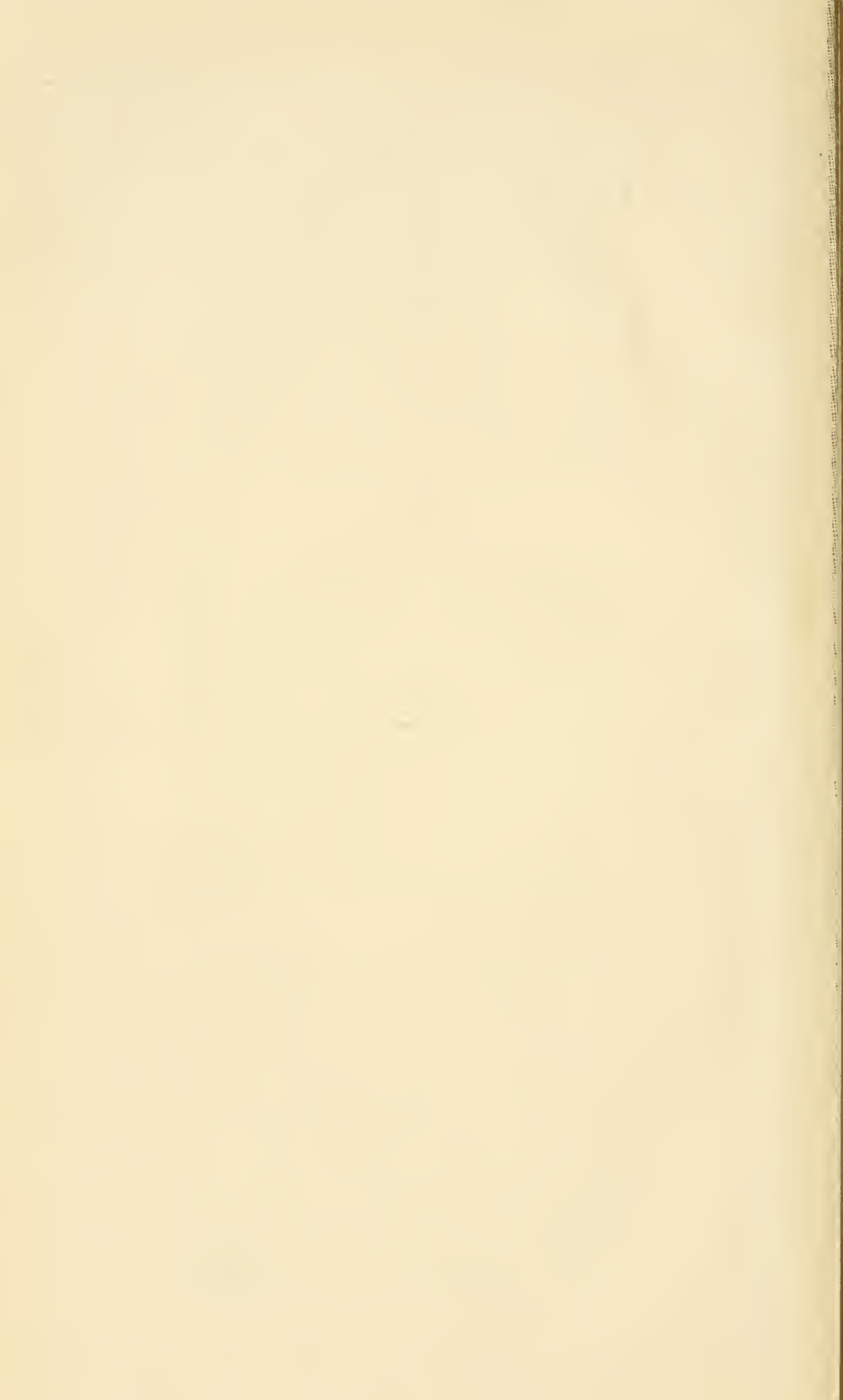



EXPLANATION OF PLATE LXXIII.

---

- Fig. 1. Women mourners—parta-maro, or plaster possessors—with their heads plastered with blobs of parta or burnt gypsum, causing the whole head of hair at a distance to appear one mass of white. Boulia District. (Reproduced from the "Queenslander," Nov. 2, 1901, by kind permission of the Editor).
2. The two forked uprights used to support the pole on which the bodies of young men placed in sheets of bark are slung previous to cremation: these uprights often give the only clue to the charred remains scattered about. Pennfather River, Cape York Peninsula.



1



2

G. WOOD, Boulia, photo. (fig. 1).  
W. E. ROTH, photo. (fig. 2).





EXPLANATION OF PLATE LXXIV.

---

Aperture in a hollow tree-butt, at a height of from four to six feet from the ground, through which the bones of a deceased person, after disinterment, were passed for final sepulchre. Coast line from Mackay on the north to Miriam Vale on the south.



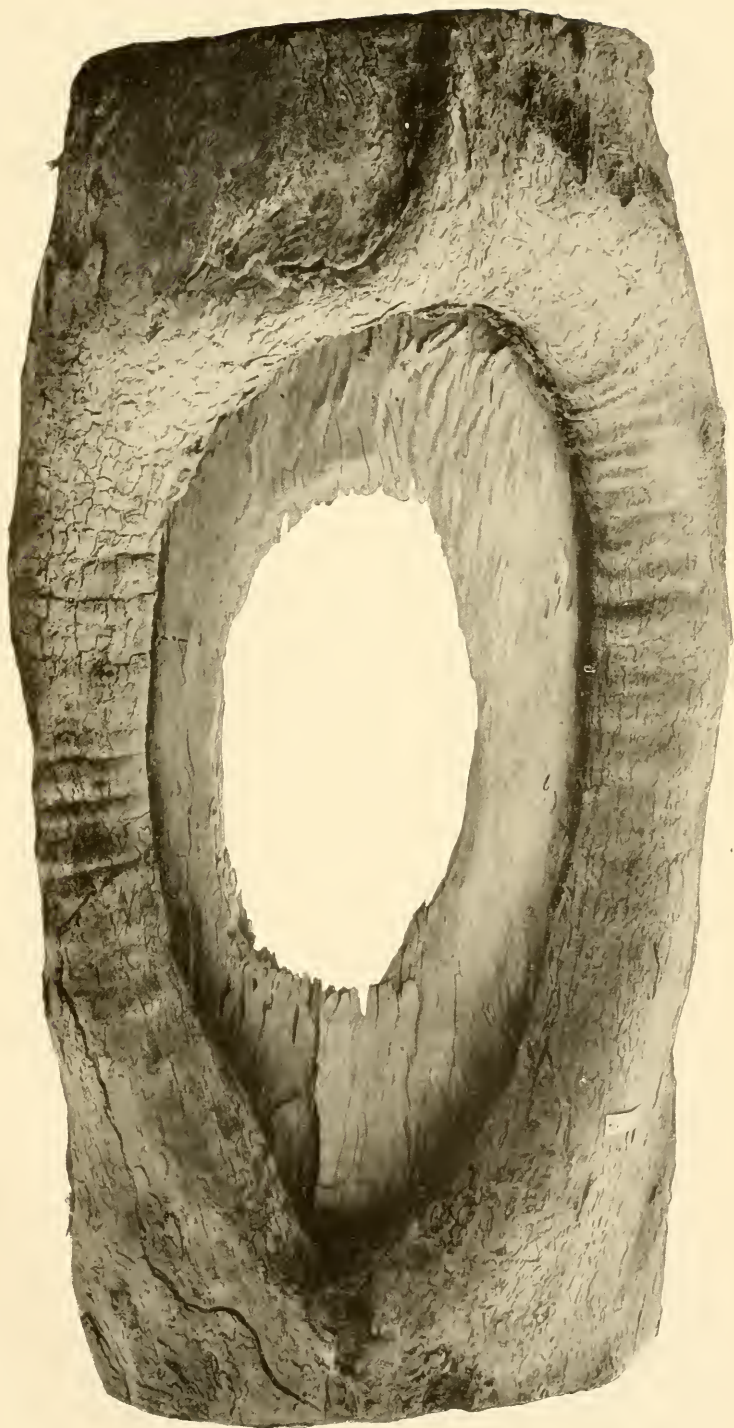

H. BARNES, Junr., photo.  
Austr. Mus.





EXPLANATION OF PLATE LXXV.

---

CASSITERITE.

- Fig. 1. Emmaville, N. S. Wales.  
.. 2. Elsmore, N. S. Wales. Doublet on  $e$  (101).  
.. 3. Elsmore. Fiveling on  $e$  in orthographic projection.  
.. 4. Stanthorpe, Queensland. Doublet on  $e$ .  
.. 5. The Glen, New England, N. S. Wales. Fourling on  $e$ .  
.. 6. Hogue's Creek, N. S. Wales.

Forms :— $a$  (100),  $m$  (110),  $r$  (230),  $h$  (120),  $e$  (101),  $s$  (111),  $z$  (231).

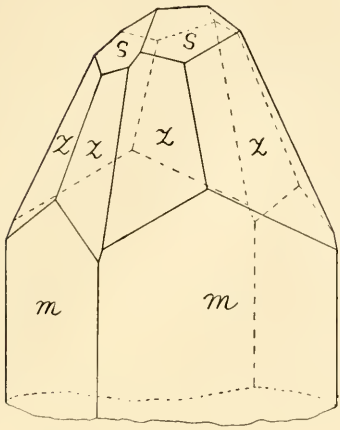

1

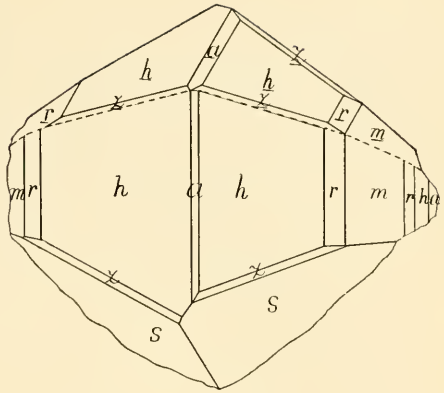

2

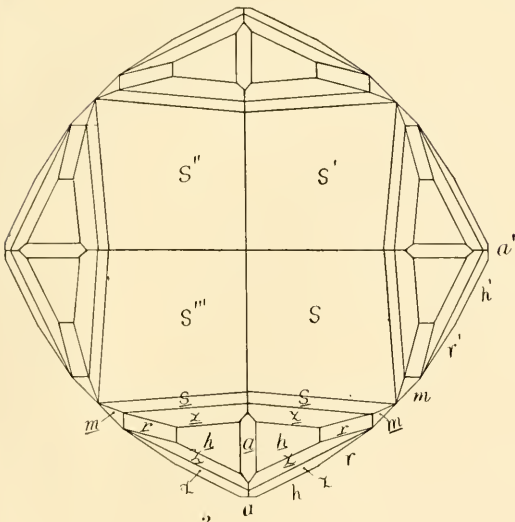

3

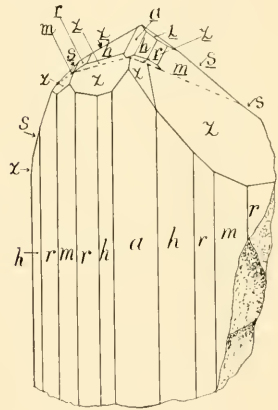

4

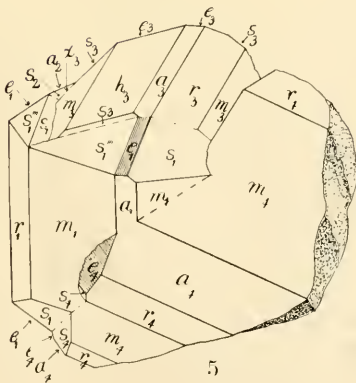

5

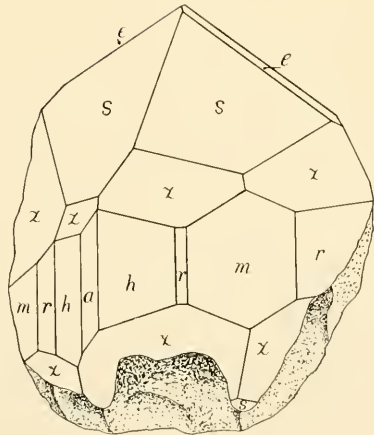

6





EXPLANATION OF PLATE LXXVI.

---

CERUSSITE.

Figs. 1 2. Broken Hill, N. S. Wales. In orthographic and clinographic projection.

Fig. 3 Broken Hill. Twin on  $r$  (130).

„ 4. Washington Extended Mine, Whyte River, Tasmania.

„ 5. Comet Mine, Dundas, Tasmania. Trilling on  $m$  (110).

Forms:— $c$  (001),  $b$  (010),  $a$  (100),  $x$  (012),  $k$  (011),  $i$  (021),  $r$  (031),  $S$  (032),  
 $z$  (041),  $u$  (051),  $y$  (102),  $s$  (121),  $p$  (111),  $o$  (112).



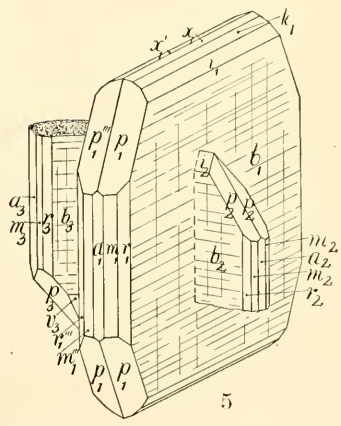
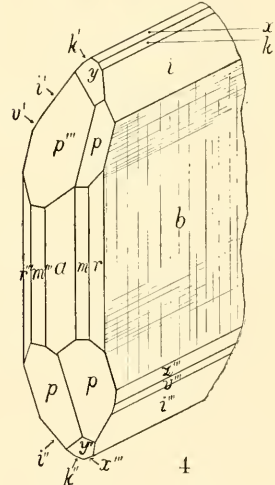
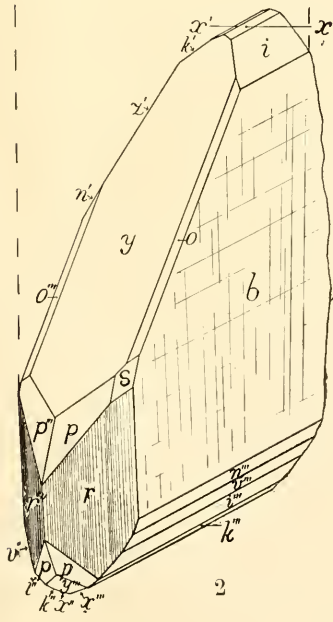
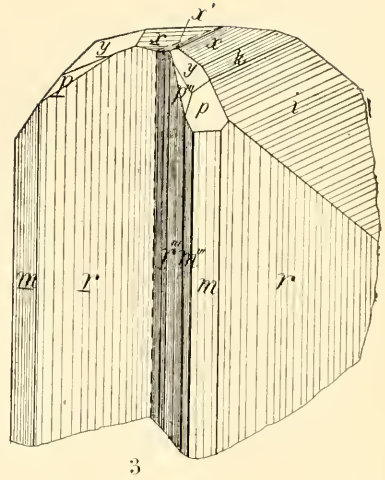
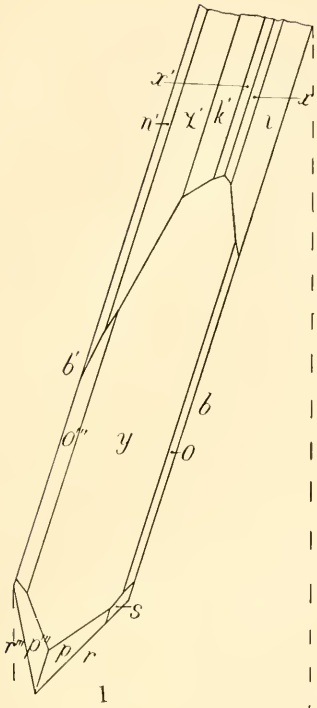





EXPLANATION OF PLATE LXXVII.

---

CERUSSITE.

- Figs. 1, 2. Broken Hill, N. S. Wales. Arrowhead twin on  $r$  (130) in orthographic and clinographic projection.  
Fig. 3. Broken Hill. Stereogram (the form  $s$  (121) is inadvertently omitted).  
,, 4. Zeehan, Tasmania. Segments subscribed 1 and 2 are twinned to each other on  $m$  (110), as are those subscribed 3 and 4.

(For lettering and indices see Explanation of Plate lxxvi.).

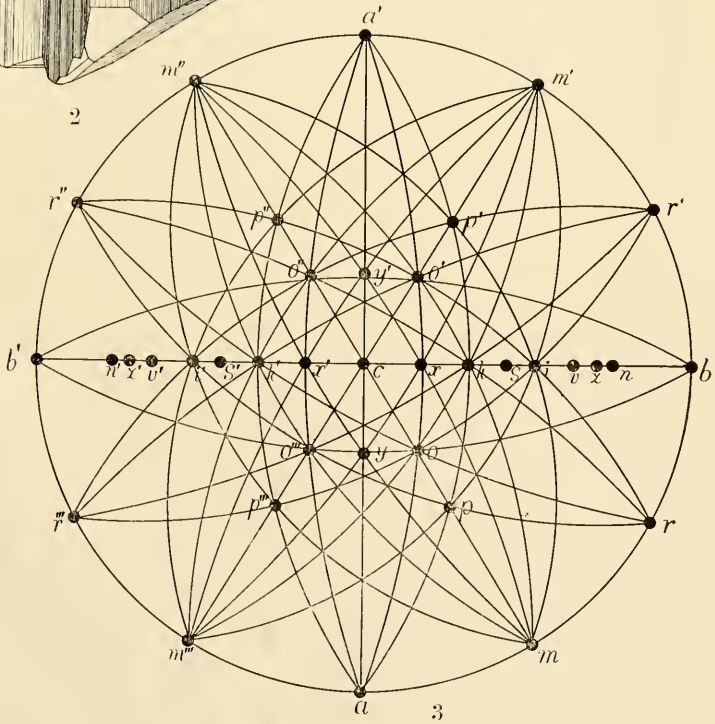
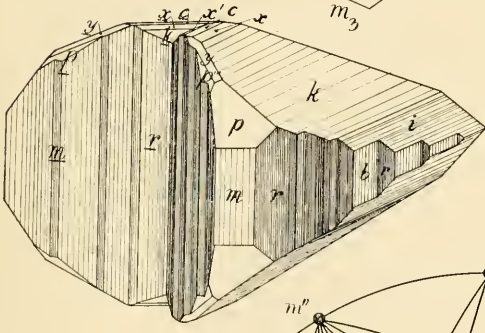
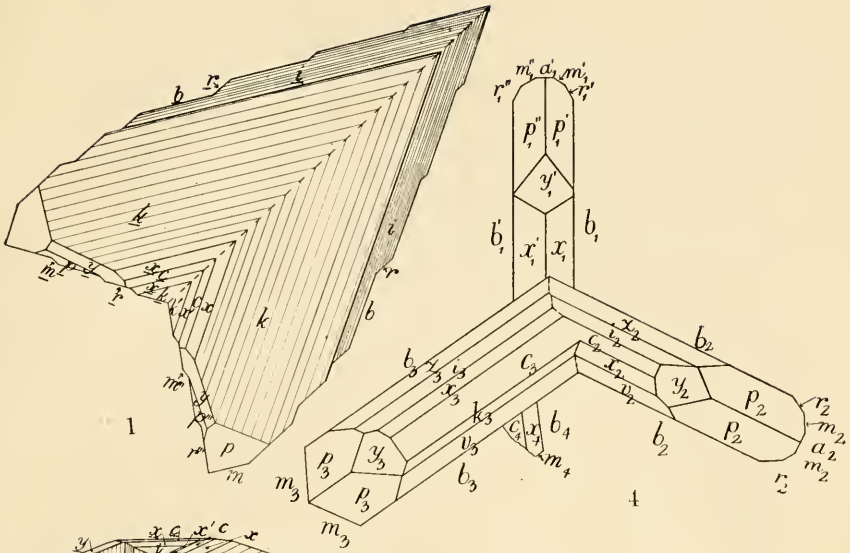





EXPLANATION OF PLATE LXXVIII.

---

Fig. 1. Barite. Commonwealth Mine, Wellington, N. S. Wales.

Forms:— $c$  (001),  $m$  (110),  $\eta$  (320),  $o$  (011),  $d$  (102),  $u$  (101),  $f$  (113),  $z$  (111),  
 $y$  (122).

Fig. 2. Monazite. The Gulf, N. S. Wales. Twin on  $a$  (100) projected on (010).

Forms:— $a$  (100),  $m$  (110),  $w$  (101),  $x$  ( $\bar{1}01$ ),  $u$  (021),  $v$  ( $\bar{1}11$ ),  $z$  ( $\bar{3}11$ ).

Fig. 3. Scheelite. Hillgrove, N. S. Wales.

Forms:— $e$  (101),  $p$  (111),  $s$  (131).

Fig. 4. Scheelite. Mount Ramsay, Tasmania.

Figs. 5, 6. Vesuvianite. Barraba, N. S. Wales. Orthographic and clinographic projections.

Forms:— $c$  (001),  $\alpha$  (100),  $m$  (110),  $e$  (101),  $p$  (111),  $t$  (331),  $s$  (311),  $i$  (312).

Fig. 7. Heulandite. Werris Creek, N. S. Wales.

Forms:— $b$  (010),  $m$  (110),  $v$  (021),  $t$  (201),  $s$  ( $\bar{2}01$ ),  $u$  ( $\bar{1}11$ ).



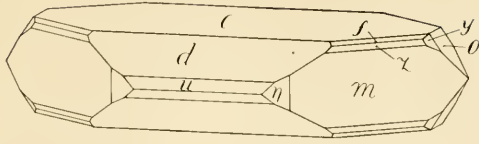

1

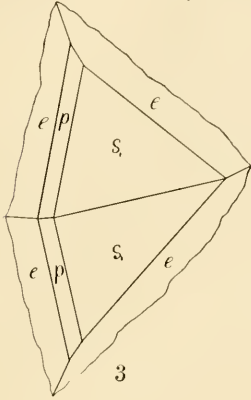

3

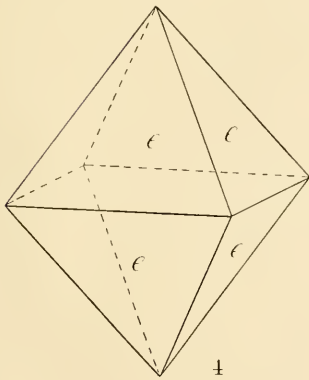

4

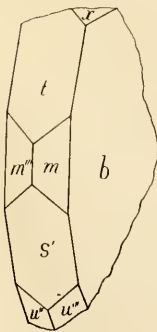

7

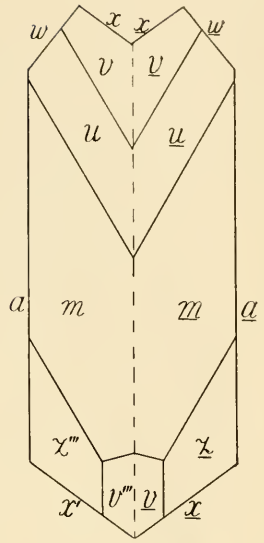

2

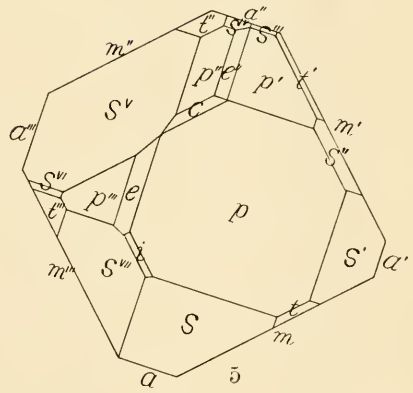

6

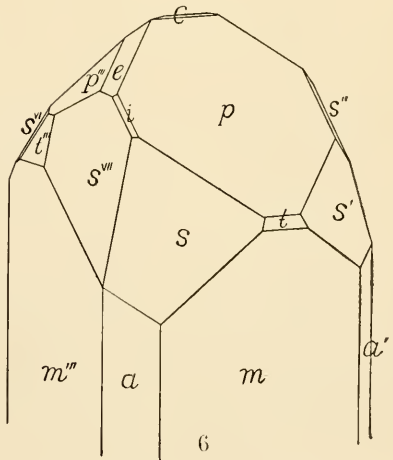





EXPLANATION OF PLATE LXXIX.

---

CHABAZITE.

- Fig 1. Ben Lomond, N. S. Wales. Penetration twin on vertical axis.  
,, 2. Ben Lomond. Apex of crystal in plan; both segments of the twin  
consist of three parts in parallel position.  
,, 3. Middlesex, Tasmania. Penetration twin on vertical axis.

Forms:— $a$  ( $11\bar{2}0$ ),  $r$  ( $10\bar{1}1$ ),  $e$  ( $01\bar{1}2$ ),  $s$  ( $02\bar{2}1$ ),  $t$  ( $11\bar{2}3$ ).

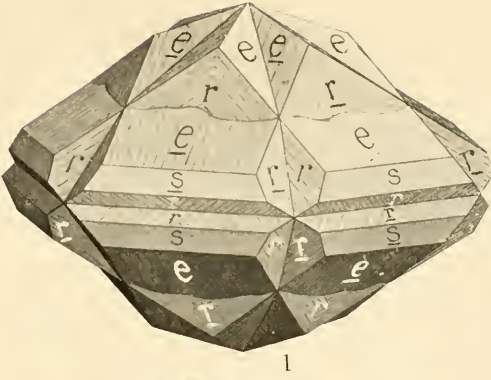

1

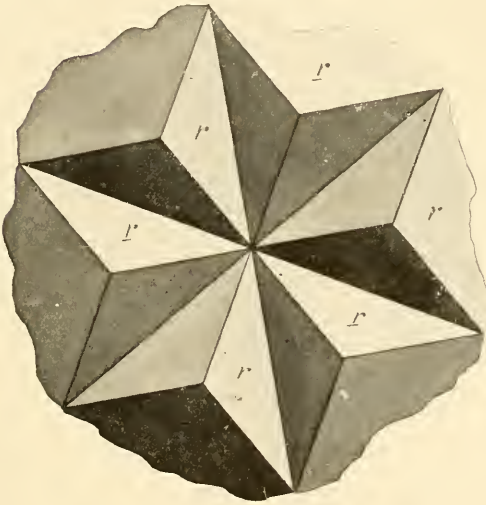

2

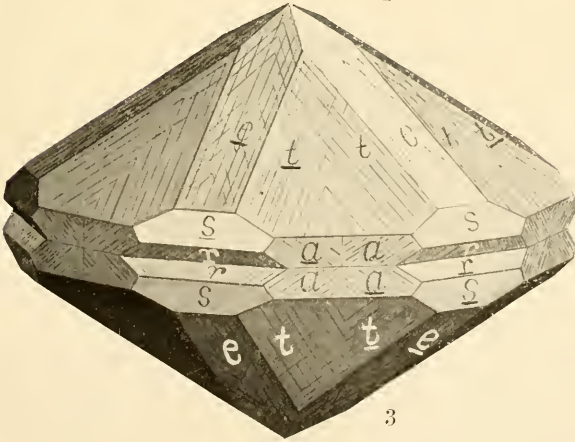

3





EXPLANATION OF PLATE LXXX.



CHABAZITE.

In basalt, Ben Lomond, N. S. Wales.

















3 2044 072 191 042

